



Swansea University  
Prifysgol Abertawe



## Swansea University E-Theses

---

# On human gut microbial ecosystem: In vitro experiment, in vivo study and mathematical modelling.

Jiang, Lei

### How to cite:

---

Jiang, Lei (2013) *On human gut microbial ecosystem: In vitro experiment, in vivo study and mathematical modelling.* thesis, Swansea University.

<http://cronfa.swan.ac.uk/Record/cronfa42214>

### Use policy:

---

This item is brought to you by Swansea University. Any person downloading material is agreeing to abide by the terms of the repository licence: copies of full text items may be used or reproduced in any format or medium, without prior permission for personal research or study, educational or non-commercial purposes only. The copyright for any work remains with the original author unless otherwise specified. The full-text must not be sold in any format or medium without the formal permission of the copyright holder. Permission for multiple reproductions should be obtained from the original author.

Authors are personally responsible for adhering to copyright and publisher restrictions when uploading content to the repository.

Please link to the metadata record in the Swansea University repository, Cronfa (link given in the citation reference above.)

<http://www.swansea.ac.uk/library/researchsupport/ris-support/>

**On Human Gut Microbial Ecosystem:  
*In Vitro* Experiment, *In Vivo* Study and  
Mathematical Modelling**

Lei JIANG

579442



**Swansea University  
Prifysgol Abertawe**

Submitted to Swansea University in fulfilment of the requirements  
for the degree of Doctor of Philosophy

Swansea University

2013



ProQuest Number: 10797916

All rights reserved

INFORMATION TO ALL USERS

The quality of this reproduction is dependent upon the quality of the copy submitted.

In the unlikely event that the author did not send a complete manuscript and there are missing pages, these will be noted. Also, if material had to be removed, a note will indicate the deletion.



ProQuest 10797916

Published by ProQuest LLC (2018). Copyright of the Dissertation is held by the Author.

All rights reserved.

This work is protected against unauthorized copying under Title 17, United States Code  
Microform Edition © ProQuest LLC.

ProQuest LLC.  
789 East Eisenhower Parkway  
P.O. Box 1346  
Ann Arbor, MI 48106 – 1346

---

DECLARATION

This work has not previously been accepted in substance for any degree and is not being concurrently submitted in candidature for any degree.

Signed ..... (candidate)

Date ..... 16/12/2013

STATEMENT 1

This thesis is the result of my own investigations, except where otherwise stated. Where correction services have been used, the extent and nature of the correction is clearly marked in a footnote(s).

Other sources are acknowledged by footnotes giving explicit references. A bibliography is appended.

Signed ..... (candidate)

Date ..... 16/12/2013

STATEMENT 2

I hereby give consent for my thesis, if accepted, to be available for photocopying and for inter-library loan, and for the title and summary to be made available to outside organisations.

Signed ..... (candidate)

Date ..... 16/12/2013

---

## Acknowledgement

I would like to express my sincere gratitude to my academic supervisors, Professor DRJ Owen (FRS, FREng) and Dr CF Li, College of Engineering, Swansea University for their continuous support of my PhD study and research, for their patience, motivation, enthusiasm and immense knowledge. Their guidance and valuable suggestions helped me in all the time of research and writing of this thesis.

I'm extremely grateful to my industrial supervisor, Dr Sue Plummer, Obsidian Research Ltd. for having given me the opportunity to work under her guidance towards this degree. She has been a constant source of inspiration and helped me at all stages of my research. I could not have imagined having a better advisor and mentor for my PhD research.

I deeply appreciate Dr Iveta Garaiova for her technical help, valuable discussion and endless encouragement during my research.

I also wish to acknowledge the tremendous support from the laboratory staff in Obsidian for their cooperation and technical help during the research.

I also appreciate the help provided by Dr Julian Marchesi at School of Biosciences, Cardiff University for sample data analysis.

This research was jointly funded by the European Social Fund (ESF) through the European Union's Convergence Programme administered by the Welsh Government, Swansea University, Obsidian Research Ltd. and the Royal Society.

Last but not least, I would like to express my profound gratitude to my family for their support.

---

## Summary

The human gut microbiota is considered to be a highly specialized organ providing nourishment, regulating epithelial cell development, modulating innate immune responses and colonization resistances, and it significantly impacts human health and disease. Despite of being extensively studied for several decades, the functionality of the microbiota colonization in the human gastrointestinal tract and the mechanisms of the interactions between the host and bacteria are still poorly understood.

This research follows a novel and unique approach, which combines the complementary strengths of *in vitro* experiment, *in vivo* study and mathematical modelling. The work undertaken has three emphases: 1) probiotic strains and their impact on human health; 2) the development of gut microbiota in infants; 3) quantification of human gut microbial ecosystem at both the species level and the system level. In the first part of this research, a versatile anaerobic continuous culture platform was implemented following a novel and unique design, which allows easy and continuous sampling and monitoring of microbial growth. A number of carefully planned *in vitro* experiments have been conducted to investigate the growth and competition of probiotic strains under different culture conditions. These *in vitro* experiments improve the understanding for the growth behaviour of the specific probiotic strains. The second part of this project analyzed 50 faecal samples collected from 9 healthy infants with administration of probiotic strains and placebo. The analysis is based on the 454-pyrosequencing technology, which reveals the complete profiles of gut microbiota in these infants and confirmed the modulation effect of the specific probiotic strains. The last part of this research focused on the development of mathematical and computational models of human gut microbial ecosystem. The outcome from this part of the research includes: a) a new bacterial growth model that overcomes the paradox of competitive exclusion caused by previous models; b) a versatile computational framework to simulate *in vitro* fermentation experiments; and c) a comprehensive mathematical model for human gut and gut microbiota that is the first model for its nature.

---

---

# Content Table

<b>Chapter 1 Introduction</b> .....	<b>1</b>
1.1 Aim and objectives .....	1
1.2 Research background .....	1
1.3 Main challenges in this research .....	3
1.4 A novel research methodology .....	3
1.5 Layout of thesis .....	4
<b>Chapter 2 Literature Review</b> .....	<b>7</b>
2.1 A short overview .....	8
2.2 <i>In vivo</i> studies .....	10
2.2.1 Conventional animals .....	10
2.2.2 Gnotobiotic and germfree animals .....	11
2.2.3 Human clinical trials .....	12
2.3 <i>In vitro</i> models .....	13
2.3.1 <i>In vitro</i> fermentation model .....	14
2.3.2 <i>In vitro</i> mucosal-associated models .....	26
2.3.3 Comparison of <i>in vitro</i> models .....	29
2.4 Mathematical and computational models .....	32
2.4.1 <i>Science</i> publications in the early 80's .....	33
2.4.2 Other pioneering work in the 1980's .....	34
2.4.3 Theoretical study of mathematical models .....	37
2.4.4 Progress in computational modelling .....	38
2.4.5 A comparison summary .....	40
<b>Chapter 3 Human Colon</b> .....	<b>41</b>
3.1 A short overview .....	42
3.2 Physiology and anatomy .....	43
3.3 Human colonic microbiota .....	46
3.4 Metabolism of human colonic microbiota .....	53

---

3.4.1 Regional difference	55
3.4.2 Carbohydrate and protein digestion	56
3.4.3 Main fermentation pathways	60
3.5 The probiotic, prebiotic and synbiotics concepts	67
<b>Chapter 4 Growth of <i>Lactobacilli</i> and <i>Bifidobacteria</i> in an <i>In Vitro</i> Batch Fermentation Model</b>	<b>71</b>
4.1 Introduction	72
4.2 Materials and methods	79
4.2.1 Commercially available probiotic strains	79
4.2.2 Chemicals and media	80
4.2.3 Batch cultivation conditions	81
4.2.4 Growth of individual <i>Lactobacilli</i> strain under different culture conditions	81
4.2.5 Enumeration of lactobacilli and bifidobacteria	82
4.2.6 pH analysis	84
4.2.7 Estimation of growth curves	84
4.2.8 Growth of LAB4B and LAB4	84
4.3 Results	85
4.3.1 Growth of <i>Lactobacillus salivarius</i> CUL61	85
4.3.2 Growth of <i>Lactobacillus paracasei</i> CUL08	88
4.3.3 Growth of <i>Lactobacillus acidophilus</i> CUL60 or <i>Lactobacillus acidophilus</i> CUL21	90
4.3.4 Growth of LAB4B and LAB4	94
4.4 Discussion	97
4.5 Conclusion	100
<b>Chapter 5 Growth of Mixture Strains with Probiotic in an <i>In Vitro</i> Continuous Fermentation Model</b>	<b>101</b>
5.1 Introduction	102
5.2 Design of an <i>in vitro</i> continuous fermentation model	105
5.2.1 A novel designed anaerobic workstation	105
5.2.2 Single-stage continuous fermentation model	106
5.2.3 Two-stage continuous fermentation model	108
5.2.4 Continuous culture microbiota	109
5.2.5 Commercially available probiotic strains	111
5.2.6 Screening the profile of mixture strains	111
5.2.7 Glucose content	113



---

5.3 Results .....	114
5.3.1 Pre-trial of the stabilization of 3 residential strains .....	114
5.3.2 Single-stage continuous fermentation with LAB4B .....	116
5.3.3 Single-stage continuous fermentation with LAB4 .....	118
5.3.4 Results of screening the profile of probiotic strains .....	119
5.3.5 Results of the two-stage continuous fermentation with LAB4B .....	123
5.3.6 Results of the two-stage continuous flow fermentation with LAB4 .....	126
5.4 Discussions .....	128
5.5 Conclusion .....	132
<b>Chapter 6 <i>In Vivo</i> Study of Gut Microbiota of Infants Based on DNA Sequencing .....</b>	<b>133</b>
6.1 Introduction .....	134
6.1.1 Background for gut microbiota of infants .....	134
6.1.2 Effects of probiotics on neonatal gut microbiota .....	136
6.1.3 Motivation and objectives of the present <i>in vivo</i> study .....	139
6.1.4 Analysis methods for gut microbiota .....	140
6.2 Materials and methods .....	144
6.2.1 Neonate faecal samples .....	144
6.2.2 Bacterial DNA extraction from faeces .....	146
6.2.3 454-pyrosequencing analysis .....	147
6.3 Results .....	148
6.3.1 Composition of neonatal gut microbiota with different modes of delivery .....	149
6.3.2 Composition of neonatal microbiota in the placebo group .....	150
6.3.3 Composition of neonatal gut microbiota in the probiotic group .....	152
6.3.4 Composition comparison between the probiotic and placebo groups .....	153
6.4 Discussion .....	155
6.5 Conclusion .....	159
<b>Chapter 7 Computer Simulation of <i>In Vitro</i> Fermentation Experiments .....</b>	<b>161</b>
7.1 Introduction .....	162
7.2 Modelling of batch fermentation .....	165
7.2.1 Single-strain batch fermentation .....	166
7.2.2 Multiple-strain batch fermentation .....	175
7.3 Modelling of chemostat fermentation .....	176
7.3.1 Single-stage chemostat fermentation .....	177
7.3.2 Two-stage chemostat fermentation .....	182

---

---

7.3.3 Prediction of a three-stage chemostat fermentation .....	191
7.4 A theoretical analysis on steady-state coexistence of microorganisms .....	193
7.5 Conclusion .....	196
<b>Chapter 8 An Integrated Model of the Human Gut and Gut Microbial Ecosystem</b> .....	<b>197</b>
8.1 Introduction .....	198
8.1.1 Aim and motivation .....	198
8.1.2 Limitations and defects of previous mathematical / computational gut models	199
8.1.3 The structure of a comprehensive mathematical for the human gut and gut microbiota .....	201
8.2 Bulk flow in the gut .....	202
8.2.1 Anatomy of gut and the new gut model .....	202
8.2.2 Mass conservation of the gut media flow .....	204
8.2.3 Momentum conservation of the gut media flow .....	205
8.2.4 The interaction between the gut wall and the gut media flow .....	207
8.3 Stokes flow of gut media .....	209
8.4 Multiphase gut media .....	211
8.5 Microbial fermentation in the gut .....	213
8.5.1 An outline of fermentation pathways .....	214
8.5.2 Mass conservation in the lumen .....	220
8.5.3 Mass conservation on the mucus layer .....	221
8.6 Summary and discussion .....	223
<b>Chapter 9 Conclusion and Future Work</b> .....	<b>225</b>
9.1 Conclusion .....	225
9.1.1 <i>In vitro</i> experiments .....	225
9.1.2 <i>In vivo</i> studies .....	226
9.1.3 Mathematical modelling .....	226
9.2 Future work .....	226
9.3 Publication .....	228
<b>References</b> .....	<b>229</b>

---

# Chapter 1 Introduction

## Abstract

This Chapter is prepared to give an overview of the global picture for this multidisciplinary PhD work. The aim and objectives of this PhD research are firstly clarified, after which the research background and its importance are briefly addressed. Then, the main research challenges are identified, for which a novel multidisciplinary research strategy is proposed. The layout of the thesis is outlined in the last section.

## **1.1 Aim and objectives**

This research focuses on the microbial ecosystem in the gastrointestinal (GI) tract of humans. The research scope covers both the profile of gut microbiota (i.e. what are present in the human gut) and the metabolic function of gut microorganisms (i.e. what do they do in our gut). Under this umbrella, there are three special emphases in this research project: 1) probiotic strains and their impact on human health; 2) the development of gut microbiota in infants; 3) quantification of gut microorganisms' activity at both the species level and the system level.

## **1.2 Research background**

The large bowel consisting of the proximal colon, the transverse colon and the distal colon forms the last part of the human GI tract, as shown in Figure 1.1. For a long time, the main function of the large bowel was thought to be water and ion absorption. However, it is now clear that the large intestine plays far more important roles than just absorbing water and ions. It contributes significantly to carbohydrate and protein metabolism, provides essential protection against pathogen invasion, and stimulates and modulates the immune system. These critical physiological functions are not so much associated with the anatomical structure of the large intestine, and instead they are accomplished by the microorganisms living in the large bowel. The large intestine of a healthy adult houses hundreds of microbial species (most of them are beneficial to man), and they form a stable and active microbial ecosystem with over  $10^{14}$  microbial cells, which is ten times larger than the total somatic and germ cells of human. The metabolic activity of gut microorganisms has also been found associated with obesity, malnutrition, neurological disorders, inflammatory bowel disease and cancer (large bowel is the third largest cancer killer in the UK) etc. The gut microbiota could be considered as a "new organ" inside the human body.

The human colon is one of the most complex ecosystems on the planet, whose normal microbial community is determined by a number of factors, including host

---

genomics, diet, age, bacterial succession, immune function and health status etc. There have been marked progresses in our understanding of the micro ecology of the GI tract in recent years. However, we are still at the very beginning of understanding the functional relationships between the microbiota and the host, in health and disease. Many fundamental questions remain outstanding: what is a healthy intestinal microbiota composition, which microbial groups and activities are involved in health and disease, what are the benefits of specific probiotic and prebiotic, is it possible and if so how to favourably manipulate the gut microbiota to improve human health and prevent and treat disease etc.

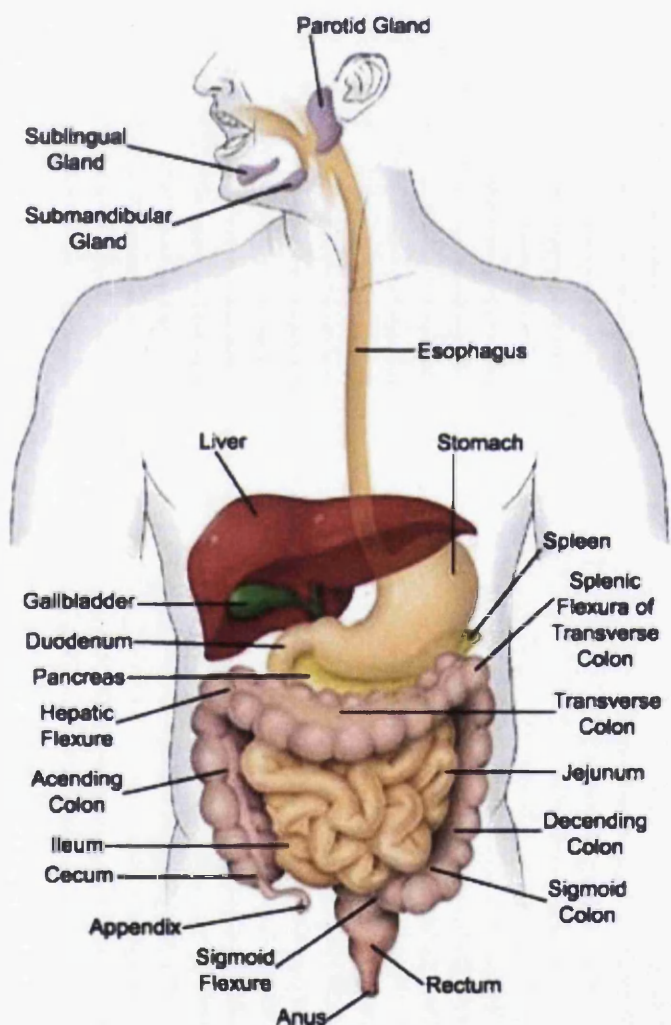

Figure 1.1 Illustration of the gastrointestinal tract of human

### 1.3 Main challenges in this research

The main challenges of researching gut microbial ecosystem arise from two aspects.

- The intrinsic complexity of the system. It is estimated that the gut microbiota of a healthy individual comprises around 400-1000 bacteria species, whose total cell count outnumbers the somatic and germ cells of man by ten times. A great variation also exists between individuals such that the profile of gut microbiota has been recognized as a microbial "fingerprint" of humans. Compared with the great diversity of the gut microbiota, their metabolic and immune functions and interaction mechanisms with the host are even more complex.
- The lack of direct measuring or monitoring approaches. Due to technical and ethical restrictions, it is very difficult to obtain accurate *in vivo* data of gut microbiota from human, and the limited data are often fragmented and corrupted with errors. Animal trials can help to some extent, but it is well known that the gut microbiota in animals have very different physiological functions and totally different population structures compared with human. *In vitro* studies have therefore become a very popular approach for studying the gut microbiota. But its complexity is highly limited. It is very difficult, if not impossible, to simulate *in vitro* even a small portion of the whole gut microbial community because a large number of microbial species in the human colon are not cultivatable with known culture media.

### 1.4 A novel research methodology

To cope with the great technical challenges reviewed above this PhD work has adopted a novel and unique research methodology, by joining together the complementary strengths of *in vitro* experiments, *in vivo* trials and mathematical modelling. *In vitro* experiments were conducted to gain knowledge on activities of individual gut microbial species in a simplified gut-like environment. By using DNA

---

sequencing technology, the *in vivo* trials provided information of the complete profile of gut microbiota in selected infants. Mathematical modelling eliminated some of the difficulties faced by *in vitro* and *in vivo* testing, and helped to gain quantitative information of gut microbial ecosystem, including its activity, function and interaction with the host.

This research strategy has led to a truly multidisciplinary research adventure, which required knowledge and skills in microbiology, engineering and mathematics. To the best of our knowledge, this work is the first research attempt that combines *in vitro* experiments, *in vivo* trials and mathematical modelling in the investigation of human gut microbiota. The research group led by Prof DRJ Owen at Swansea has extensive experience and world-leading expertise in mathematical modelling and engineering computations. However, this PhD research project is the group's first step in the direction of gut microbiology, and the associated challenges should not be underestimated.

## 1.5 Layout of thesis

The layout of the main body of the thesis is summarized below:

**Chapter 2** provides an up-to-date and comprehensive review on the research of gut microbial ecosystem and its relation to human health and disease. The review divides previous research works into three groups according to their research methodologies: *in vivo* trials, *in vitro* experiments and mathematical modelling. The advantages and disadvantages of all three research approaches are discussed and compared.

**Chapter 3** briefly recaps the knowledge of the human colon, including the physiology and anatomy of the large intestine, the microbiota composition, metabolic activities and functions of the gut microbiota. The concepts of probiotic, prebiotic and synbiotics are also introduced in this Chapter. This Chapter is prepared to make the thesis self-contained and more accessible to the engineering and mathematical

readership. Efforts have been made to accurately summarize the information in the most efficient manner.

**Chapter 4** describes a series of *in vitro* batch fermentation experiments. These experiments were performed to study the growth of several probiotic strains in different culture media and different pH conditions. Experience gained from these experiments helped the design of a continuous fermentation platform used in later experimental study. The data obtained was also used in a later stage to validate the new bacteria growth model proposed in this work.

**Chapter 5** proposes a unique design of a continuous fermentation platform and describes a series of fermentation experiments involving multiple gut microorganisms and probiotic strains. The continuous fermentation platform served as a prototype *in vitro* gut simulator while the associated fermentation experiments simulated microbial competition in a gut-like environment. These experiments provided insights on how the specific probiotic strains react in the simulated gut environment. The resulting data were also used in the validation of the new mathematical model.

**Chapter 6** describes an *in vivo* study involving 9 healthy infants with administration of probiotic strains during the first 6 months after birth. The DNA sequencing technique (454-pyrosequencing) was used to analyze the infants' faecal samples collected at different stages, and complete gut microbiota profiles were obtained. These *in vivo* testing results show that the specific probiotic strains did have a positive impact on the development of gut microbiota in the selected infants.

**Chapter 7** proposes a versatile computational model that can accurately simulate various *in vitro* fermentation experiments. The computational model is based on a new bacterial growth model, which extends the classic Monod model and overcomes the paradox of competitive exclusion. The new simulation platform was validated



against the *in vitro* experiments described in Chapter 4 and Chapter 5, and good achievement has been achieved in all cases.

**Chapter 8** proposes an integrated mathematical model of human gut and the gut microbial ecosystem. The new mathematical model takes into account the deformation and volume change of human gut, and models the large bowel as an elastic tube. Also for the first time, the nature of low Reynolds' number flow is recognized for the gut media. To capture the different movement of food particles, biomass, water and gas in the large intestine, a multiphase flow model is introduced. Finally, based on the new bacteria growth model validated in Chapter 7, a comprehensive fermentation model has been developed and built into the gut model. To the best of our knowledge, this new mathematical gut model is the first theory of this nature.

**Chapter 9** summarizes the main achievement and research outcome from this PhD research, and also provides insight to future research.

## Chapter 2 Literature Review

### Abstract

The human gut microbiota is considered to be a highly specialized organ providing nourishment, regulating epithelial cell development, modulating innate immune responses and colonization resistance, and therefore significantly impacts human health and disease. However, to understand the functionality of the microbiota colonization in the human GI tract and to unravel the mechanisms which control interactions between the host and bacteria, researchers must deal with the individuality and complexity of the microbial ecosystem in a largely inaccessible habitat. In order to provide a functional view of the microbial ecosystem, continuous efforts have been made in the past few decades and a number of useful tools and strategies have been developed, which includes *in vivo*, *in vitro*, *in silico* and mathematical models. To lay this research work in the right research context, this Chapter reviews the related research over the past few decades that have contributed to a better understanding of the human gut microbial ecosystem.

## 2.1 A short overview

The human gastrointestinal (GI) tract has a complex, dynamic and spatially diversified microbial ecosystem which is established and maintained throughout a human's whole life. This complex microbial ecosystem in the human gut harbours about 200 grams living cells, with peak numbers in the colon (about  $10^{14}$  microorganisms), in total numbers which are estimated to outnumber human somatic and germ cells by a factor of ten (Turnbaugh et al., 2007). Despite such high numbers, the microbial diversity is relatively low and the human gut microbiota is dominated by only two bacterial phyla, Firmicutes and Bacteroidetes that make up over 90% of the intestinal microbiota (Eckburg et al., 2005). The intestinal habitat of an individual contains 500 to 1,000 different species of bacteria (Eckburg et al., 2005). A recent analysis involving a larger number of subjects has suggested that the collective human gut microbiota is composed of over 35,000 bacterial species (Frank et al., 2007). The intestinal microbiota is not homogeneous and colonization of the human gut with microbiota starts immediately at birth (Fouhy et al. (2012a); Cheng et al. (2013)). The microbiota composition is unstable from host birth until the age of 2-4 years, but adult hosts carry a stable host-specific microbial community which then becomes unstable with increasing age (Mackie et al. (1999); Zoetendal et al. (1998); Blaut et al. (2002); dos Santos et al. (2010); Biagi et al. (2012); Duncan et al. (2013)). Factors that shape the human microbiota ecosystem can be roughly classified into two categories: host factors (e.g. acid, bile, pancreatic secretion, peristalsis and food transit times, and host genotype) and environmental factors (e.g. food components, ingestion of microbiota and drugs) (Egert et al. (2006); Shanahan et al. (2013)).

The gut microbiota is a highly specialized organ providing nourishment, regulating epithelial cell development, modulating innate immune responses and colonization resistance, and therefore significantly impacts human health and disease (Xu et al. (2012); Matamoros et al. (2013)). Perturbations of gut microbial community structure and functionality are associated with chronic health conditions and

---

intestinal diseases such as allergies and asthma, obesity, diabetes, inflammatory bowel disease and colon cancer (Sekirov et al. (2010); Ballal et al. (2011)). The Human Microbiome Project (HMP) launched in 2008 by the United States National Institutes of Health was developed to systematically gain insight into the features of the microbiome including the stability and resiliency of the microbiome, similarities between the microbiomes of people within families/communities, the existence of an identifiable core biome, and the effects of the genetic diversity of the biome (Turnbaugh et al., 2007). These features would allow for better understanding that how the microbiome affects human health and disease and how this can be used to better improve the health and well-being of the host.

The human gut microbiota, particularly its composition, metabolic activities and products that may influence the host, have been intensively studied in the past few decades. However, some considerable methodological problems have been raised to study the composition and metabolism of the gut microbiota. Whether or not it is feasible to study the microbial ecology of the intestine (Corpet, 1989)? Whether or not there is a prospect of unravelling the mechanisms which control interactions between the hundreds of species which make up a flora, and host-bacteria relationships (Corpet, 1989)? Does it present considerable methodological problems to study the composition and metabolism of the colonic flora (Boureau et al., 2000)?

At first sight it would be impossible to study millions of microbiota which are difficult to collect from the human gut because of the special physic-chemical conditions and also the fact that many of these microbes have not been cultured or classified. However, a number of *in vivo* and *in vitro* experimental models to simulate the human colon and its microbial population have been developed to enable metabolism or mechanisms to be studied. An understanding of interactions within the intestine can sometimes be achieved by mathematical modelling which are normally considered as an alternative to the *in vivo* and *in vitro* studies (Corpet, 1989). Yet, there is no single ideal method that has intrinsic advantages or disadvantages over the other methods for studying the ecology and metabolic

---

activities of the gut microbiota. All the methods must be combined together according to their complexity, convenience and suitability to provide a more accurate view of the ecosystem (Boureau et al., 2000).

## **2.2 *In vivo* studies**

*In vivo* studies for the exploration of the human gut microbiota encompass various species of laboratory animals, gnotobiotic animals or human volunteers. During the past several decades, a number of animal models have been used to study the dynamic, ecologically diverse community of microorganisms that inhabit the GI tract and provide a better understanding of the biological complexities of the processes that govern host-microbiota symbiosis. These simplified models could provide us with insights about how the colonization of the host affects vital host processes. They are also a powerful tool to study the individual microorganism so that unique roles for different gut microbiota can be established and put in the context of different health and disease perspectives (Sekirov et al., 2010).

### **2.2.1 Conventional animals**

Conventional animal species have been widely used for studying human gut microbiota stabilization, colonization and colonization resistance, treatment of antimicrobial agents and selected drugs' administration (Burr et al. (1982); Gorbach et al. (1988); Van der Waaij et al. (1990); Nielsen et al. (1992); Mysore et al. (1994); Pazzaglia et al. (1994); Berends et al. (1996))). The mouse is the most common model compared with other species (even its large intestine differs substantially from human), followed by guinea pig, pig, chicken, Japanese monkey, Mongolian gerbil, ferret and quail (Boureau et al., 2000). Heidt et al. (1990) established colonization resistance in specific pathogen free rats using a rat-derived microflora. Fleming et al. (1991) used rat models to study the short chain fatty acid (SCFA) absorption in the cecum. Caplan et al. (1994) developed a neonatal rat model of necrotizing enterocolitis (NEC), a common gastrointestinal disorder affecting premature infants. Bovee-Oudenhoven et al. (1996) studied the effects of calcium and fermentation by

---

yoghurt bacteria on the resistance of rats to *Salmonella* infection. Whitman et al. (1996) developed a model of gastrointestinal colonization with vancomycin-resistant *Enterococcus faecium* in CF1 mice to study factors promoting colonization and the efficacy of decontamination therapy with antimicrobial agents. Lan et al. (2007) studied the survival and metabolic activity of propionibacteria on the gastrointestinal tract of human-associated rats. Sato et al. (2008) studied the fermentation pattern of administration of lactate-utilizing bacteria with ingestion of galacto-oligosaccharides (GOS) in a rat model. Kondo et al. (2010) used a mouse model with obesity induced by high-fat diet to evaluate the antiobesity activity of a bifidobacterial strain and the result showed that the specific probiotic strain was effective in reducing the risk of obesity. Shi et al. (2013) investigated the potential health-promoting effect of a specific *Lactobacillus gasseri* strain on the metabolic characteristics of metabolic syndrome rats.

Conventional animals have many advantages: (i) full realism in the case of farm animals; (ii) much fewer ethical restrictions than the human model; (iii) good control over environment (diet, stress etc.); (iv) good control over genetics of subject population; (v) accessibility of their intestinal contents, tissues and organs at autopsy; (vi) irreplaceable control of gnotobiotic and genetically engineered animal models (Boureau et al., 2000). However, conventional animals still have many limitations such as complexity of the model makes interpretation of results difficult and ethical restrictions still apply etc.

### **2.2.2 Gnotobiotic and germfree animals**

A novel approach to the study of the cross-talk that occurs between microorganisms and their hosts is based on the use of gnotobiotic and germfree animal models (Xu et al. (2003); Phillips (2009)). These animal models provide useful information about how bacteria affect normal development, establishment and maintenance of the immune system and epithelial cell functions. Gnotobiotic animals demonstrate the importance of the indigenous microbiota in protecting against intestinal colonization by exogenous bacteria. Bacteria are difficult to colonize in the intestinal tracts of

---

conventional animals, whereas the same microorganisms are able to colonize in the germfree animals (Moberg et al., 1978). Yi et al. (2012) reviewed that the germfree murine is a powerful model to study the relationship between gut microbiota and the host. The advantages of gnotobiotic and germfree animals are (i) good control over flora parameters; (ii) reduced complexity of flora facilitates interpretation of the data. However, it still has a few disadvantages: (i) reduced realism (fewer interspecies and host microflora interactions); (ii) the complexity of host makes interpretation of results complex (Boureau et al., 2000).

Studies with gnotobiotic animals include colonization, colonization resistance, interspecies interaction and host responses etc. For example, Hazenberg et al. (1981) who inoculated germfree mice with suspensions of human faeces demonstrated that the total bacterial composition in the model was similar to that of man and was distinct from the indigenous murine flora. These animal models are also very useful to investigate the administration of probiotics in animals when challenged with pathogens. De Macias et al. (1992) studied the protective effect of *Lactobacillus casei* and *Lactobacillus acidophilus* against *Shigella sonnei* infection. Kabir et al. (1997) investigated the antagonistic activity exerted by *L. casei* against *S. enterica* serovar Typhimurium. Rodrigues et al. (1996) showed lactobacilli protection against *Salmonella typhimurium* and *Shigella flexneri* colonization in the mice model. Becker et al. (2011) introduced a simplified human intestinal microbiota (SIHUMI) to the gnotobiotic rats to investigate the effect of dietary interventions on the composition of the faecal samples. Faith et al. (2011) studied the interrelationships between four different diets and the changes of human gut microbial community which was introduced into gnotobiotic mice. Tlaskalova-Hogenova et al. (2011) reviewed the role of gut microbiota in the human diseases using germfree and gnotobiotic animal models.

### **2.2.3 Human clinical trials**

The gut microbiota has also be studied *in vivo* using healthy human volunteers, hospital patients, ileostomists and sudden death victims. Obviously, when possible, a

---

human volunteer trial with placebo control and blind coded samples are the best models for studying the gut microbiota ecosystem. Plummer et al. (2005) investigated the effects of probiotics on the composition of the intestinal microbiota following antibiotic therapy. This double-blind placebo-controlled study showed that daily supplementation with viable probiotic bacteria during and post antibiotic therapy reduces the extent of disruption to the intestinal microbiota. It also reduces the incidence and total number of antibiotic-resistant strains in the re-growth population. Allen et al. (2010) evaluated the safety of probiotic for the prevention of atopy in a neonatal clinical trial. Bartosch et al. (2005) showed symbiotic (a combination of probiotic and prebiotic) consumption containing bifidobacteria and oligofructose protect the faecal bifidobacterial populations, which are often dramatically reduced in older people. Fraher et al. (2012) reviewed a few techniques that can be used to characterize the complexity of gut microbiota and to provide a guideline for the clinician. Weichert et al. (2012) focused on the evidence of prebiotic and probiotic in prevention and treatment of pediatric infectious diseases. Hell et al. (2013) reviewed the possible role of multistrain probiotic in *Clostridium difficile* infection.

However, there are still some limitations for the human clinical trial. It is difficult to collect samples from gut contents and tissues because of technical and ethical restrictions. The types of foods or drugs that can be administered to human volunteers are restricted. Many of these clinical trials suffer from low compliance and high drop-out rates.

### **2.3 *In vitro* models**

Both human clinical trials and animal experimental works are expensive and require specialist facilities compared with *in vitro* models (Smith et al., 2007). *In vitro* models complement animal and human studies and are an alternative choice to simulate the conditions in the human GI tract. *In vitro* models offer further simplification and a further level of control to investigate both the existence of gut

---



microbial species and their related functionalities, although they suffer from the absence of a complete physiological and host response environment. *In vitro* model could help researchers uncover the role of gut microbiota in everything from digestion and nutrient absorption to disorder conditions such as inflammatory bowel disease. *In vitro* model can be used sequentially to simulate the upper GI tract (stomach, duodenum, jejunum, ileum) and the colon (proximal, transverse and distal colon).

The use of an *in vitro* model to study the human gut microbiota offers various advantages: (i) low cost to operate; (ii) easy to set-up; (iii) good control over species in model flora; (iv) rapid turnaround and throughput of samples; (v) good access to flora in all parts of the model system; (vi) allow precise manipulation of environment variables; (vii) possible use of toxic substances; (viii) ethical restrictions are absent. However, the disadvantages of *in vitro* models are: (i) it will reduce realism without host immune or neuroendocrine system functionality; (ii) mucosal and luminal models have not yet been integrated; (iii) other biotic factors are usually not incorporated into the models (e.g. gut absorptive processes and digestive tract secretions) (Boureau et al., 2000). *In vitro* model can be divided into *in vitro* fermentation model and *in vitro* mucosal-associated model. *In vitro* fermentation models can be further distinguished as batch cultures, continuous cultures and artificial digestive models. All models are anaerobic to simulate the environment that supports the growth of microbiota obtained from a human's faecal sample.

### **2.3.1 *In vitro* fermentation model**

The simplest and most widespread *in vitro* fermentation model has broadened from batch culture to single- or multistage continuous flow models for investigating microbial processes such as carbohydrate and protein fermentation, metabolism production using different faecal inoculation techniques (Cinquin et al. (2006a); Macfarlane et al. (2007); Van den Abbeele et al. (2010)). Each type of model has its own advantages and limitations. In order to set up an appropriate model, the study objectives should be carefully evaluated.

---

### 2.3.1.1 Batch fermentation models

Batch fermentation models (Figure 2.1) are the simplest and most common method to study the effect of different added ingredients in the batch fermentor with intestinal fluid or fecal slurry. These models are usually closed systems with sealed vessels or reactors containing suspensions of pure or mixed bacteria in a carefully selected medium without further addition of nutrients. The run-times in batch fermentation models are relatively short ranging from 2 to 24 hours (Rumney et al. (1992); Barry et al. (1995); Oufir et al. (2000)). The potential use of prebiotic such as fructans or resistant starch or other complex carbohydrates have been studied in batch fermentation models (Pompei et al. (2008); Lesmes et al. (2008)). Noack et al. (2013) investigated the fermentation and microbiota profiles of three fibers in an *in vitro* batch fermentation model. Beards et al. (2010) investigated the bacterial, SCFA and gas profiles in batch fermentation with human colonic microbiota. Arboleya et al. (2013) studied the modulation ability of 16 different bifidobacteria strains and fructooligosaccharides (FOS) in an *in vitro* faecal batch cultures. Knudsen et al. (2013) investigated the effect of 3 different insoluble carbohydrates on the microbial community and fermentation products in an *in vitro* batch fermentation model inoculated with human fresh faecal samples. A large number of substrates and fecal samples were tested using the batch fermentation model to investigate the metabolic profiles of short chain fatty acids (SCFAs) (Macfarlane et al. (2007); Gumienna et al. (2011); Arboleya et al. (2013)).

Short-term batch fermentation models allow a rapid screening and a flexible design to assess the inter-individual variability. However, the control of changing conditions is not possible because most batch fermentations proceed without pH control and the accumulation of fermentation products (e.g. SCFAs) results in continuous changes to pH and redox potential. Moreover, only short term experiments can be conducted to avoid selection of non-representative microbial populations and accumulation of toxic products.

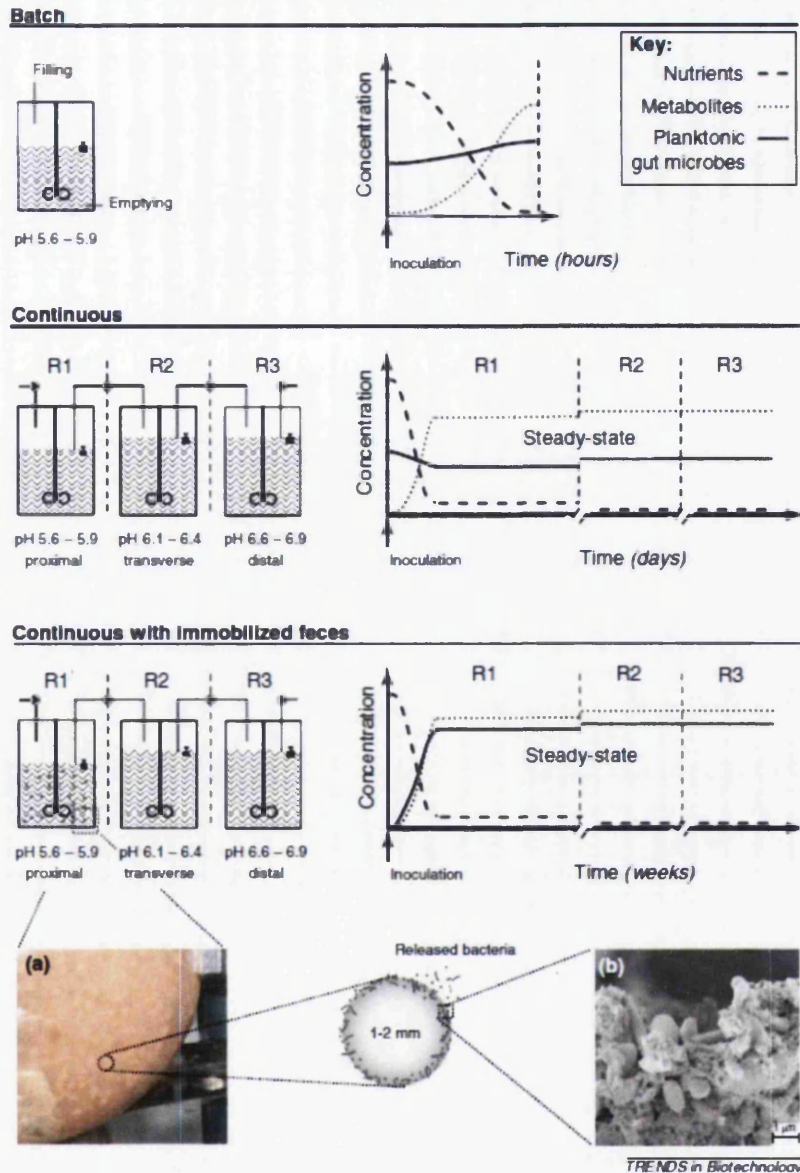

Figure 2.1: *In vitro* fermentation models simulating proximal (R1), transverse (R2) and distal (R3) colons, operated at physiological section-specific constant pH, temperature (37°C) and under strictly anaerobic conditions (e.g. through continuous CO<sub>2</sub> or N<sub>2</sub> flushing of the headspace). (a) Picture detail of a proximal colon reactor containing polysaccharide beads with immobilized fecal microbiota. (b) Electron microscope image of microbes embedded and attached to the surface of an intestinal bead (Payne et al., 2012a).

### 2.3.1.2 Continuous fermentation models

More complex fermentation models with several vessels and continuous substrate replenishments can be used to evaluate the microbial community and microbial metabolic modulation to avoid this accumulation of metabolites and depletion of

nutrients (Payne et al., 2012a). Since the first *in vitro* colon simulator was introduced in 1981 (Miller et al., 1981), the function of all models today have a lot in common with this model. Runney et al. 1992 reviewed the first decade of *in vitro* gut fermentation models. The Reading model developed by Gibson and his colleagues in 1988 (Gibson et al., 1988a), revised by Macfarlane and co-workers in 1998 (Macfarlane et al., 1998), is still actively used today.

### ***Single-stage continuous fermentation models***

Single-stage continuous fermentation models use a single chemostat for fermentation and are often adopted to elucidate proximal colon function and metabolic activities. For example, a single-stage continuous fermentation model for *Salmonella* colonization in the proximal colon was developed and used to compare the effects of antibiotic therapy and *Bifidobacterium thermophilum* RBL67 on salmonellosis in child gut environments (Le Blay et al., 2009). The single-stage continuous fermentation model has been used to investigate bacterial population and SCFA ratios within microbial communities from the human colon in various pH and peptide supply (Walker et al. 2005). Studies on alternative dietary substrates, competition between human colonic bacteria and the role of pH in determining the composition of the human colonic bacteria were carried out in single-stage fermentation models (Duncan et al. (2003); Duncan et al. (2009)). It is a useful model for specific regions of the GI tract under physicochemical controlled conditions. Nevertheless, stability of the gut microbial community under long term studies is not always possible.

### ***Multi-stage continuous fermentation models (e.g. the Reading model)***

An extension of the single-stage continuous flow chamber is the use of multiple stages which enable the simulation of horizontal colon processes to perform long time study of the gut microbiota ecosystem (Figure 2.1).

The Reading simulator (Gibson et al. 1988a) simulates the colon using a three-stage continuous culture with three vessels (220 ml, 320 ml, and 320 ml) and different pH

---

in each vessel (5.8, 6.2 and 6.8) to mimic the human ascending, transverse and descending colon, respectively. Macfarlane et al., 1998 revised and validated this model using measurements made on colonic contents taken from sudden death victims. The system is usually inoculated with human faecal slurry in a batch overnight, after which the continuous overflow from vessel to vessel begins and the system is run for at least 14 days in order to achieve a steady-state condition in the vessels (Macfarlane et al., 1998). Then a specific compound will be tested for 3 weeks and finally, to determine how long the changes induced by the test substrate can still be measured during a washout period (2 weeks) in the absence of the substrate itself (Macfarlane et al., 1998).

Considerable work has been carried out in recent years to investigate the carbohydrate utilization, fermentation product formation and interspecies interactions (cross feeding) using the various multistage fermentation models (Cinquine, et al. (2006b); Belenguer et al. (2006); Chassard et al. (2006); Falony et al. (2006); Macfarlane, et al. (2007); Zihler, et al. (2010); Van den Abbeele, et al. (2010)). As probiotic, prebiotic and synbiotic modulation on fermentation pattern and microbiota composition is very important to promote human health, a lot of studies have been performed using *in vitro* multistage fermentation models (Langlands et al. (2004); Amaretti et al. (2007); Stewart et al. (2008); Falony et al. (2009)). For example, a comparative study on carbohydrate fermentation showed FOS and polydextrose were bifidogenic in all three culture vessels of the gut model system (Probert et al., 2004a). Non-digestible carbohydrates were investigated to stimulate the growth of specific groups of beneficial bacteria (predominately bifidobacteria and lactobacilli) in the large bowel (Rastall et al., 2005). Effects of antibiotics on the microbiota composition and metabolic activities were studied in a three-stage continuous fermentation model which mimics a highly simplified gut ecosystem with 14 defined populations of human gut microorganisms (Newton et al., 2013).

---

***Immobilized continuous fermentation models***

The traditional continuous fermentation models inoculated with diluted fecal slurry present several limitations due to the free-cell state of their microbial populations (Cinquin et al., 2004). They may not be fully representative for both planktonic (free-cell) and sessile (biofilm-associated) states of bacterial populations in the colon (Macfarlane et al., 2007). Moreover, both the lower cell density inoculation ( $< 10^9$ - $10^{10}$  CFU mL<sup>-1</sup>) (Probert et al., 2004a) compared with colonic contents ( $10^{10}$ - $10^{11}$  CFU mL<sup>-1</sup>) and the rapid washout of less competitive bacteria limit the operational time to less than 4 weeks (Sghir et al. (1998); De Boever et al. (2001)). To address problems associated with inoculum washout, Doleys et al. (2002a, 2002b) and Cinquin et al. (2004) developed a single-cultured chemostat where bacteria were immobilized on a porous polysaccharide gel beads either in suspension or biofilm-associated. The fecal microbiota could be successfully immobilized and stabilized for 54 days, and also high density cells could release from beads and eventually enable growth of free cells in the simulator (Cinquin et al., 2004).

However, the single-cultured chemostat developed by Cinquin et al. (2004) can only simulate the ascending colon. A three-stage chemostat model was then developed by incorporating two additional chemostats to represent the three physiological regions of the human colon (Cinquin et al., 2006b). After faecal microbiota are suspended within the gel beads to form fecal beads, the beads are transferred to the growth medium in the first reactor. Cells release from the beads once a high-cell density peripheral layer is formed because of the limitations on substrate and toxic product diffusion within beads. The released cells are transported to the second and the third reactors, resulting in a relatively high-cell density in all three reactors. More recently, Zihler et al. (2011) studied the protective effect of probiotics on *Salmonella* infectivity using an *in vitro* three-stage fermentation model with immobilized child microbiota. Payne et al. (2012b) assessed the impact of different dietary on microbiota composition and metabolism using a three-stage continuous fermentation model inoculated with immobilized child faecal sample. The immobilized continuous

fermentation models enable prolonged operation time depending on the objective of the study: 29 days as reported by Cinquin et al. (2004), 54 days by Cinquin et al (2006b) and 71 days by Le Blay et al. (2010).

### 2.3.1.3 Artificial digestive systems

Besides the aforementioned batch and continuous fermentation models, microbiologists and engineers also designed more sophisticated dynamic *in vitro* simulators to mimic all physic-chemical conditions in the GI tract to better understand the gastrointestinal microbial community and its metabolic activity (Molly et al. (1993); Minekus et al. (1995); Macfarlane et al. (2007)). These systems aim to recreate *in vivo*-like conditions such as gastric juice, pancreatic juice and bile salts secretion, peristaltic motility, absorption capacities, high shear forces and finally, host-microbiota interaction.

Several research groups have developed artificial digestive systems to simulate the GI tract both on a structural and a functional level. The SHIME<sup>®</sup> model (ProDigest and Ghent University, Gent, Belgium) (Figure 2.2) and the TIM model (TNO, Delft, The Netherlands) (Figure 2.3) are widely received by the research community due to their comprehensiveness. Several other research groups also developed their own GI tract models for specific scientific focuses. EnteroMix<sup>®</sup> colon simulator was introduced by Makivuokko and co-workers at Danisco Innovation in 2005 (Figure 2.4) (Makivuokko et al. 2005). A computer controlled dynamic GI tract model used for studies on the administration of biotherapeutics has been developed by Satya Prakash et al. in McGill University, Canada (Prakash et al. 2011) (Figure 2.5). A ‘Robogut’ which contains six steel and glass vessels to mimic gut conditions in people who suffer from inflammatory bowel disease (IBD) was set up by Emma Allen-Vercoe et al. at Guelph University, Canada in 2009 (Figure 2.6).

---

**SHIME<sup>®</sup> model (simulator of the human intestinal microbial ecosystem)**

The SHIME model (simulator of the human intestinal microbial ecosystem) was originally developed by Molly et al. (1993). The conventional SHIME is a dynamic model of the human gut comprising 5 reactors respectively simulating the stomach, small intestine and ascending, transverse and descending colons. The first two reactors mimic the enzymatic and physicochemical environment by controlling pH, residence time, and the dosing of a proper nutritional medium, enzymes and bile salts (Molly et al., 1993). These two reactors are the fill and draw system with a dialysis filter which is used to simulate the absorptive processes occurring in the stomach and the small intestine (Vermeiren et al., 2011). The last three-stage reactors to simulate the large intestine are continuously stirred vessels with fresh faecal sample inoculation which corresponds to that of the *in vivo* situation in terms of metabolic activity and community composition. However, there is no absorption simulated in the last three-stage model. In this model a typical stabilization period of three weeks and a basal period of two weeks are followed by treatment and wash-out periods.



Figure 2.2: TWINSHIME System: two SHIME systems are run in parallel (Source from <http://www.prodigest.eu>).

Since the SHIME model was developed on 1993, it has been used by different researchers for different research targets. For example, the SHIME model has been employed to study the impact of various chemical compounds such as polycyclic

---



aromatic hydrocarbons (PAH), arsenic, insecticide and isoxanthohumol on the composition of the gut microbiota (Van de Weile et al. (2003); Laird et al. (2007); Laird et al. (2013); Possemiers et al. (2006); Joly et al., 2013). The SHIME model has also been used to study the effect of various probiotics and prebiotics on the gut microbiota ecosystem (Kontula et al. (1998); Alander et al. (1999); Ganzle et al. (1999); Van de Wiele et al. (2004); Van de Wiele et al. (2007)). The TWINSHIME<sup>®</sup> model (Figure 2.2) was developed to investigate two different treatments under identical parameter settings (Grootaert et al., 2009). Two further extensions of the SHIME model have been recently conducted to improve the simulation power of the GI tract model. A more detailed description of this is given in Section 2.3.2.

### *TIM model (TNO intestinal model)*

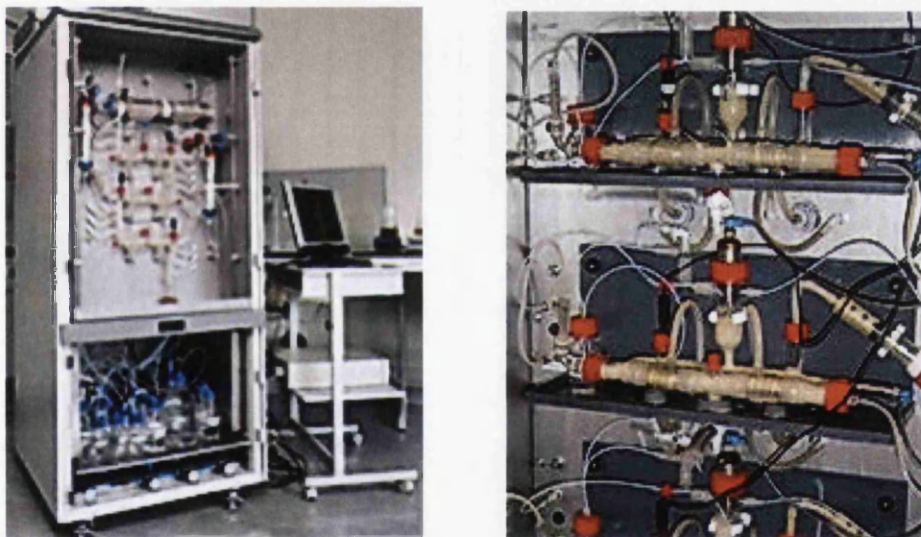

Figure 2.3: TNO-Intestinal Models: TIM1 (left) and TIM2 (right) (Source from <http://www.tno.nl>).

Another well known artificial digestive system is TNO's gastrointestinal model (TIM). This model comprises two complementary parts, TIM1 and TIM2 introduced by Minekus and co-workers in 1995 and 1999. The TIM 1 system (Figure 2.3 left) contains eight glass modules mimicking the stomach, duodenum, jejunum and ileum including bile secretion, motility, pH controlled and absorption capacities (Minekus et al., 1995). The TIM 2 (Figure 2.3 right) system consists of four glass modules in a

loop mimicking the proximal colon with peristaltic mixing, water and metabolite absorption using a hollow fiber membrane (Minekus et al., 1999). The TIM model differs from other models in two main aspects: (i) fluid transportation from vessel to vessel happens via peristaltic valve-pumps; (ii) there is a constant absorption of water and fermentation products through dialysis membranes. TIM1 has two integrated 5 kDa dialysis membranes, next to the jejuna and ileal modules and TIM2 has one hollow-fiber membrane which has molecular mass cut-off of 50 kDa (Minekus et al., (1995); Minekus et al. (1999)).

TIM1 can simulate the real-time digestive process from stomach to ileum. TIM2 only simulates the proximal colon. TIM2 is inoculated with fecal slurry and its microbiota is allowed to adapt to the fermentation conditions for 16 hours. However there is no long-term stabilization of the microbial community and the volumes in the different chambers are small when compared with *in vivo* situations. Since Minekus et al. (1995) validated the computer-controlled multi-compartment model (TIM1) to simulate the stomach and small intestine, considerable work have been done using the TIM model. Marteau et al. (1997) used the TIM1 model to investigate the survival of lactic acid bacteria, particularly the effect of bile salt in stomach and small intestine. In recent years, the combination of both TIM1 and TIM2 models has been applied to pharmaceutical investigations of drug delivery, molecule bioconversion and nutrient compound bioavailability (Blanquet-Diot et al. (2003); Souliman et al. (2006); Souliman et al. (2007); Blanquet-Diot et al. (2009); Anson et al. (2009); David et al. (2010); Dickinson et al. (2012)).

### **EnteroMix<sup>®</sup> colon simulator**

The EnteroMix model is based on semi-continuous culture and it has four parallel units each comprising four glass vessels (V1-V4) to mimic caecum & ascending, transverse, descending and sigmoid colons, allowing four simulations to be run simultaneously using the same fecal inoculum (Figure 2.4) (Makivuokko et al. (2005, 2006, 2007, 2010)). The pH levels of V1-V4 are controlled at 5.0, 6.0, 6.5 and 7.0, respectively. The model reaches steady state 3 hours after incubation of a fecal

---

sample, and the initial working volumes of V1-V4 are 3, 5, 7 and 9 ml respectively. Three ml of fresh medium, with (three channels) or without (one channel) test substance, is pumped to V1. After 3 hours fermentation, the fermented media are transferred to V2 and simultaneously 3 ml of fresh medium is pumped to V1. After 3 hours fermentation in V2, the fermented media will be transferred to V3. Similarly, after 3 hours fermentation in V3, the fermented media will be transferred to V4. The culture is allowed to ferment in V4 for 3 hours before discharging. The whole procedure of transferring liquids from V1 to V4 is 15 hours. Finally, the working volume is 6, 8, 10 and 12 ml, respectively. The fermentation lasts for 48 hours, after which samples are collected from each vessel and the simulation is terminated. The EnteroMix model has been used to study carbohydrate fermentation as well as synbiotic effects of lactitol and specific *L. acidophilus* strain.

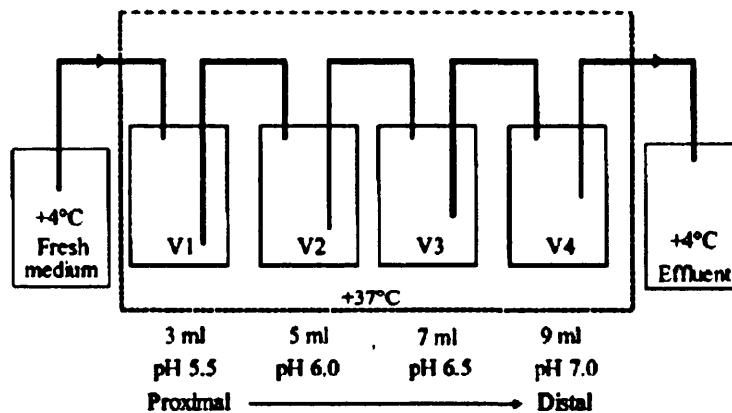

Figure 2.4: EnteroMix colon simulators (Makivuokko et al., 2006).

The EnteroMix model allows four parallel simulations to be run at the same time with the same fecal inoculums and same substrates. This model has the smallest working volumes, enabling the simulation of small concentrations of the tested substrate. However, the operational volumes are small when compared with the *in vivo* situation. As a result, there is no stabilization of the microbial community and only short-term experiments can be performed.

---

*Other artificial digestive models*

Figure 2.5: A computer-controlled dynamic human gastrointestinal model (Prakash et al., 2011).

Shown in Figure 2.5 is a computer-controlled dynamic human gastrointestinal model developed in McGill University, Canada (Prakash et al. 2011). Similar to the SHIME, it consists of a succession of five vessels mimicking the stomach, the small intestine, and the ascending, transverse and descending colons. The system is computer automated whose temperature, pH and anaerobic parameters are all controlled using the Labview® software (Martoni et al. (2007); Martoni et al. (2008); Prakash et al. (2011)). This model has been mainly used to study the biotherapeutics modulation (prebiotics, probiotics and antibiotics) and delivery formations (e.g. microencapsulated probiotics). For example, Martoni et al. (2007) investigated the performance of microencapsulated *Lactobacillus plantarum* 80 cells for oral delivery applications in the simulated GI tract. Encapsulated lactobacilli (Bile salt hydrolase over producing strains) are suggested to lower cholesterol levels in the human gut. The results showed the microencapsulated process could protect the lactobacilli in the simulated stomach prior to intestinal release, and also maintain the higher cell viability in the whole simulator.

Shown in Figure 2.6 is the ‘Robogut’ simulator developed by Allen-Vercoc at Guelph University, Canada. The \$300,000 system was set up in 2009, and it contains six steel and glass vessels to mimic the human distal gut. The system has been used

---

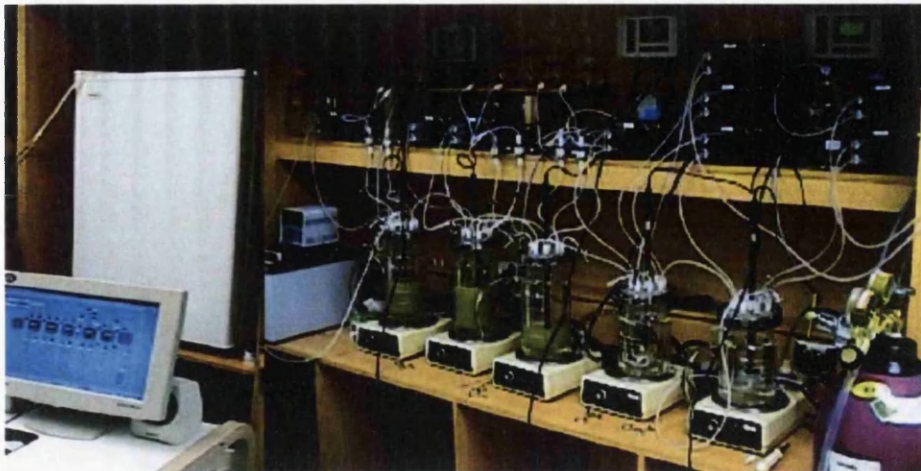
to culture fecal samples from healthy adults, and the cultured artificial fecal is then filtered to select a set of beneficial bacteria for successful treatment in diarrhoea (Petrof et al., 2013). The researchers reported that the treatment with synthetic poop successfully cured the infections of two patients by planting the selected beneficial bacteria into their intestines during colonoscopies. The new bacteria slowly grew in the patients' guts and pushed out the toxic *C. difficile*, eliminating the cause of infection.



Figure 2.6: Robogut developed Emma Allen-Vercoe in Guelph University. (Source from: <http://www.uoguelph.ca>)

### 2.3.2 *In vitro* mucosal-associated models

All the models presented until now do not take into account an important aspect in the GI tract: adhesion of microorganisms to the mucus layer, biofilm formation and its potential role on the host physiology, structuring of the microbial community and cross-talk (Marzorati et al., (2010, 2011)). It is therefore desirable to simulate *in vitro* the host response through a mucosal-associated model. Several studies have been made mostly based on enterocytes, enterocyte-like cells or mucosal explants to mimic the bacterial adhesion in the gut wall mucus layer (Ouwehand et al., (1999, 2002); Probert et al. (2004b); Macfarlane et al. (2005); Van den Abbeele et al. (2009); Bahrami et al. (2011)).

For example, the influence of normal faecal flora on the adhesion of a probiotic to the mucosa was studied by using an immobilized mucus *in vitro* model (Ouwehand et al., 1999). The same author also studied the adhering potency of candidate probiotic in the new model with colonic tissue (Ouwehand et al., 2002). Probert et al. (2004b) developed a fermentation model of the proximal colon that includes mucin beads to mimic mucus gel layer microhabitat with dialysis membrane. The system is inoculated with fecal samples, and water and metabolites are removed by osmosis using a solution of polyethylene glycol. Macfarlane et al. (2005) used sterile porcine mucin gels in small glass tubes to determine how intestinal bacteria colonize and degrade mucus in a two-stage continuous culture system. These tubes can be placed in a fermentor simulating a specific area of the GI tract and removed over a period of 48h for further analyses of the biofilm. Van den Abbeele et al. (2009) studied the adhesion assay of the mucin colonization of bacteria from the SHIME. Bahrami et al. (2011) studied the adherence and cytokine induction in Caco-2 cells by bacterial populations from a three-stage continuous fermentation model.

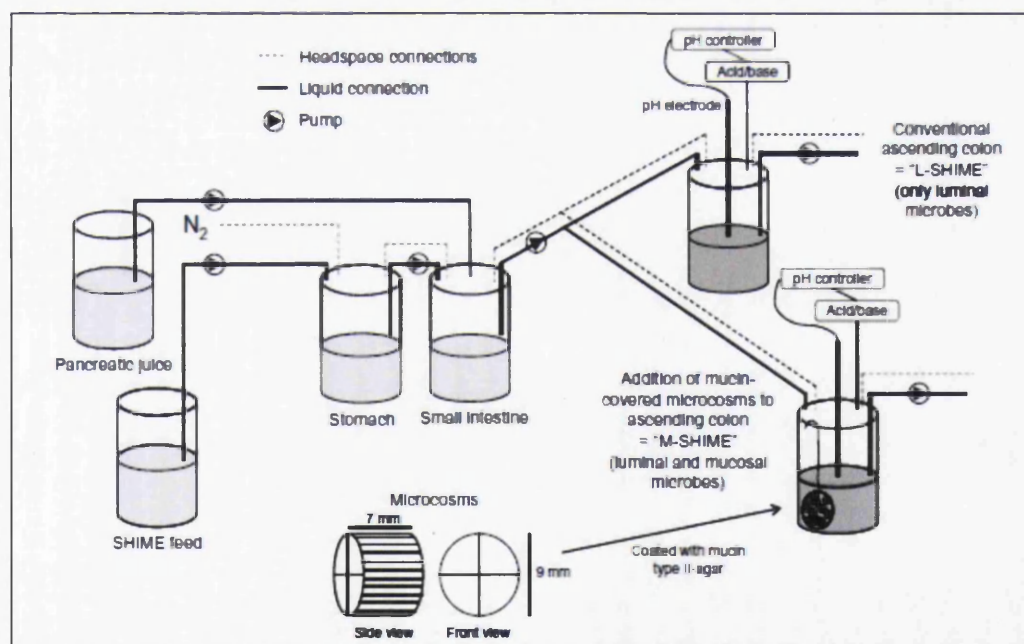

Figure 2.7: M-SHIME (The design was based on the SHIME. The first ascending colon unit consists of the conventional set-up that only harbors luminal microbes (= luminal SHIME or L-SHIME), whereas the second unit is modified by incorporating a mucosal compartment (= mucosal SHIME or M-SHIME), which contains 100 mucin-covered microcosms per 500 ml suspension. Both units run in parallel in order to attain identical environmental conditions

and identical microbial composition and activities for both units (Van den Abbeele et al., 2012).

However, none of the aforementioned models simulating the GI tract has an adequate device to study the mechanisms of bacterial adhesion in response to the host signals and the reciprocal cross-talk (Marzorati et al., 2010). Two further developments have been recently conducted by the research group who developed the SHIME. One is M-SHIME (Mucus-SHIME) and the other is the HMI (Host-Microbiota Interaction) model (Vermeiren et al. (2011); Marzorati et al. (2012)).

In the M-SHIME, a mucosal compartment (mucin-covered microcosms coated with mucin type II-agar) is introduced in the ascending colon vessel to reproduce the bacterial adhesion to the gut wall mucus layer (Figure 2.7) (Van den Abbeele et al., 2012). This improvement aims to provide more *in vivo*-like communities in long-term dynamic *in vitro* simulations and allow evaluating the colonization of unique mucosal microbiota in health and disease (Van den Abbeele et al., 2012). Vermeiren et al. (2012) compared the colonization of microbiota in the mucin layer and luminal compartment between health volunteers and ulcerative colitis patients in the M-SHIME. Van den Abbeele et al. (2013) also studied that mucosal butyrate producers specifically colonize in the mucin layer in the M-SHIME.

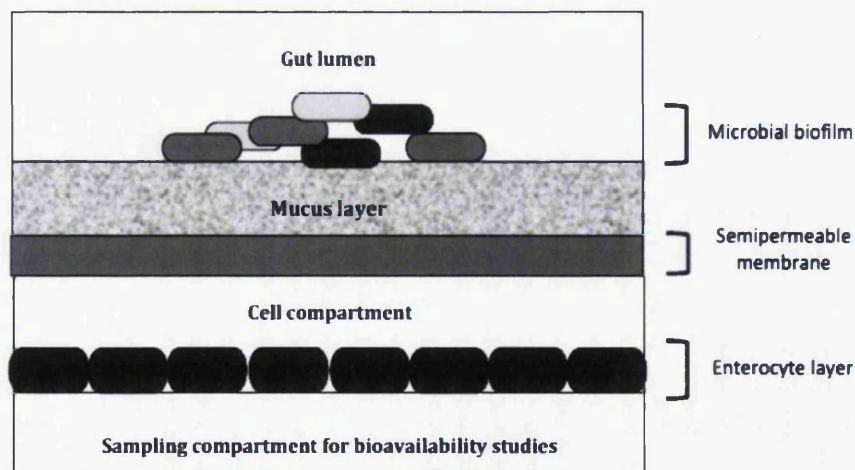

Figure 2.8: The host-microbiota interaction (HMI) module (Marzorati et al., 2010).

The HMI model consists of two compartments separated by a functional double-layer composed of an upper mucus layer and a lower semi-permeable membrane. The mucus layer on the luminal side is coated with an artificial mucus layer to adhere the microorganisms in the luminal compartment. The use of artificial mucus layers is advantageous compared to the use of mucus layers formed by epithelial cells, since direct interaction and cytotoxicity between the microorganisms and the epithelial cells is prevented. The epithelial cells and/or other cell types can be grown in the basal compartment of the module and the semi-permeable membrane allows the secretion products of these cells to diffuse through the membrane and the artificial mucus layer. Furthermore, the use of two separate compartments allows the establishment of different oxygen pressures on both sides of the membrane to establish the optimal conditions for the aerobic epithelial cells in the basal compartment and the anaerobic microorganism in the luminal compartment. The combination of these features provides a novel tool to investigate the role of microbial metabolism on the biotransformation of active compounds and facilitate studies related to new drug development (Vermeiren et al., 2011). This model can be combined with SHIME to evaluate the effect of microbial processes on the host cells and the effect of host cells on microbial processes (Figure 2.8) (Marzorati et al., 2010).

### **2.3.3 Comparison of *in vitro* models**

The *in vitro* models mentioned above have structural and functional difference (Table 2.1). However, the solutions used to reproduce the conditions in the GI tract are similar in each model. Firstly, nearly all models use the medium inoculated with fecal samples to represent the microbiota population in the human colon, because it is very difficult, both ethically and technically, to obtain the realistic samples from the ileum or cecum of humans. Secondly, similar growth media are used in these *in vitro* models which originate from the media published by Macfarlane et al. in 1998 mimicking the ileal fluids obtained from sudden death victims (Macfarlane et al.,



1998). Thirdly, all models simulate the basic environment of the GI tract such as anaerobic conditions, similar pH set-point and similar retention time.

Batch fermentation models have a simple and flexible design to assess the inter-individual variability. But they are commonly limited to short-term simulation to avoid selection of non-representative microbial populations and accumulation of toxic products. The Reading model is the most popular continuous fermentation model to simulate the human colon and many researchers today also use similarly designed models to investigate the gut microbiota ecosystem. With respect to more sophisticated *in vitro* GI tract models, SHIME and TIM are the most widely recognized models, which provide control of the concentrations of gastric, small intestinal and pancreatic enzymes, bile, pH, temperature, feed composition, transit time in the GI tract and the anaerobic environment with physiological relevance. The EnteroMix model is the colon simulator with the smallest working volumes, enabling simulation of small concentrations of testing substrates.

The TIM model is specially designed for pharmaceutical investigations of drug delivery and performing bioavailability studies in the upper GI tract, while the SHIME model is mainly designed to simulate metabolism in the whole human gut. The EnteroMix model is the only model allowing four parallel simulations to be run at the same time with the same faecal inoculum and same substrate. These systems simulate the gut controlled by physicochemical conditions but do not offer the opportunity of studying the microorganism adhesion, the gut biofilm formation and the host-microbial interaction etc. M-SHIME is an *in vitro* mucus-associated model to enable the bacterial adhesion to the gut wall mucus layer. This improvement enables evaluation of the colonization of unique mucosal microbiota related to human health and disease. HMI is another recently developed *in vitro* adhesion model. It allows growth, stabilization and study of microbial communities that adhere to and colonize host-related surfaces, and also mimics transport of chemical compounds across epithelial surfaces to simulate host-microorganism interactions and adaptation. A comparison of all major gut models is given in Table 2.1.

---

Table 2.1 Comparison of *in vitro* gut models

	Batch fermentor	Reading model	SHIME	M-SHIME	HMI	EnteroMix	TIM1	TIM2
Simulation area	Only one part of GI tract	Colon	Stomach to colon	Stomach to proximal colon	One part of colon; can combined with SHIME	Colon	Stomach to ileum	Proximal colon
Vessel volumes	100-1000ml	220-320ml	300-1600ml	300-1600ml	N/A	6-15ml	200ml	200ml
pH levels	Set up a initial pH without pH controlled	5.8-6.8	2.0-7.0	2.0-7.0	5.5-7.0	5.5-7.0	1.8-6.5	5.8
Running time	10-48 hours	14 day to steady state	30 days per cycle	30 days per cycle or depend on study	Depend on Study	2 days	~ 1 day	~ 3 days
Peristaltic movement	No	No	No	No	No	No	Yes	Yes
Absorption process	No	No	Yes (Only the first two vessels)	Yes (Only the first two vessels)	No	No	Yes	Yes
Mucus layer involved	No	No	No	Yes	Yes	No	No	No
Host-microbiota interaction	No	No	No	No	Yes	No	No	No

## 2.4 Mathematical and computational models

In theory, *in vivo* trials on humans are the preferred ultimate research strategy for the most reliable investigation of the human GI microbial ecosystem. But in practice, due to ethical and technical constraints, it is rarely possible to conduct the required testing on sufficient number of healthy individuals and/or targeted patient groups. *In vivo* experiments using animals provides an alternative route. But it has long been well known that animals' GI systems have very different microbial population structures with very different physiology mechanisms. Hence, care must be taken when interpreting the results obtained from animal trials. Another major drawback of conducting animal experiments is the high cost and special skills required. Due to these disadvantages of *in vivo* trials, *in vitro* experiments have become a very popular approach for studying the microbiota in human GI tract. As reviewed in Section 2.3, a number of artificial gut simulators have been designed and built, and they all have their own advantages and disadvantages. A common drawback of various *in vitro* gut simulators is their limited complexity, when compared with the real microbial population in the human GI tract. It is estimated that at least 40-60% microbial species in the human GI tract cannot be cultured *in vitro*. Also, most gut simulators do not simulate the absorption function of the human digestive system, the peristaltic movement of the GI tract, or the interaction with the immune system. High time cost is another major drawback of *in vitro* experiments. A rigorous *in vitro* study can often take several months to run the complete fermentation process, while the repeatability is questionable.

Some of the aforementioned difficulties associated with *in vivo* trials and *in vitro* experiments can be overcome by mathematical / computational models. Using computational simulation based on appropriate mathematical models, one can easily take into account the physiological interactions and metabolic processes that are difficult to implement through *in vitro* experiments. Also, issues like high cost and questionable repeatability are no longer a worrying problem.

---

The potential benefit from mathematical modelling has long been recognized for the research of human GI microbial ecosystem, with early papers dated back to the 80's. The total number of publications in this area is, however, very small (until now, fewer than 30 journal papers in total), which implies limited impact. But the research on mathematical modelling of human gut microbiota never stopped in the past two to three decades. Every five years or so, there were one or two new research groups attracted to this topic, with the old groups leaving. Over all, unlike the *in vitro* experiment research theme reviewed in Section 2.3, the research progress in mathematical / computational modelling for human gut microbiota presents a mixed picture, for which a comprehensive and critical review is given below in a chronological order.

#### 2.4.1 Science publications in the early 80's

Published in *Science*, Hansen et al. (1980) studied two microorganisms competing for a single nutrient in a chemostat. For the growth history of microbiota, they compared the results directly measured from the *in vitro* cultivation and the theoretical predication based on the classic Monod growth model. With notable differences between the experimental and theoretical results, the authors claimed the agreement between the theory and the experiment, and made a conclusion that two microorganisms competing on a single nutrient cannot coexist in a chemostat environment. In this paper, Hansen et al. (1980) did not explicitly address the human gut ecosystem, but the mathematical model used in their work and the related conclusion has had a profound impact on the later work in mathematical modelling of human gut microbiota. The mathematical model they used is

$$\frac{dS}{dt} = (S_0 - S)D - \frac{\mu_1}{y_1} \frac{SN_1}{K_{S_1} + S} - \frac{\mu_2}{y_2} \frac{SN_2}{K_{S_2} + S} \quad (2.1)$$

$$\frac{dN_1}{dt} = \frac{\mu_1 SN_1}{K_{S_1} + S} - DN_1 \quad (2.2)$$

$$\frac{dN_2}{dt} = \frac{\mu_2 S N_2}{K_{S_2} + S} - D N_2, \quad (2.3)$$

where  $S$  denotes the concentration of nutrient in the chemostat,  $t$  time,  $S_0$  the nutrient concentration of the inflow,  $D$  the dilution rate,  $\mu_i$  the maximum growth rate of the microorganism  $i$ ,  $y_i$  the yield coefficient,  $K_s$  the half-velocity constant, and  $N_i$  the concentration of microorganism  $i$ .

Soon after Hansen et al.'s *Science* publication, Fredrickson et al. (1981) published a review article in *Science* on the topic of microbial competition. At the conceptual level, Fredrickson et al. summarized and classified various possible forms of microbial competitions, and envisaged the complexity of the microbial ecosystem as the result of the multidimensional competition. Hansen et al.'s conclusion of competitive exclusion (1980) was generalized in this paper to the so called pure and simple competition, which refers to a microbial community with only one nutrient whose availability affects the growth rates of the populations, and competition for this nutrient is the only interaction between the populations. Following the basic Monod growth model in Eqns. (2.1-2.3), it is easy to prove that multiple microorganisms cannot coexist at a steady state in pure and simple competition. However, this "nice and clean" conclusion directly contradicts the common observation that bacteria always coexist in the real-world environment. Indeed, pure, or single population, cultures are almost always the creations of microbiologists. To address this contradiction, Fredrickson et al. attributed its cause to external factors, such as time-varying inputs, environmental heterogeneity and diversity of resources. This general opinion significantly influenced the later research of mathematical modelling of gut microbiota, despite that Fredrickson et al. (1981) did not explicitly target the human gut microbial environment.

#### 2.4.2 Other pioneering work in the 1980's

---

Rolf Freter is perhaps the first researcher who attempted to apply mathematical modelling to gut microbiota. In a series of publications, Freter et al. (1983a, 1983b, 1983c, 1983d) presented a systemic investigation of microbial competition in the large intestine, which includes continuous-flow cultures, mouse trials and mathematical modelling. Freter (1983d) extended the chemostat model in Eqns. (2.1-2.3) by adding the wall adherence effect. That is,

$$\frac{dS}{dt} = (S_0 - S)D - \frac{\mu_1 S(N_1 + N_1^*)}{y_1 K_{S_1} + S} - \frac{\mu_2 S(N_2 + N_2^*)}{y_2 K_{S_2} + S} \quad (2.4)$$

$$\frac{dN_1}{dt} = \frac{\mu_1 SN_1}{K_{S_1} + S} - DN_1 - \alpha N_1 W + N_1^* \lambda + \frac{\mu_1 SN_1^*}{K_{S_1} + S} \frac{0.1A}{W + 0.1A} \quad (2.5)$$

$$\frac{dN_2}{dt} = \frac{\mu_2 SN_2}{K_{S_2} + S} - DN_2 - \alpha N_2 W + N_2^* \lambda + \frac{\mu_2 SN_2^*}{K_{S_2} + S} \frac{0.1A}{W + 0.1A} \quad (2.6)$$

$$\frac{dN_1^*}{dt} = \frac{\mu_1 SN_1^*}{K_{S_1} + S} \frac{W}{W + 0.1A} - N_1^* \lambda + \alpha N_1 W \quad (2.7)$$

$$\frac{dN_2^*}{dt} = \frac{\mu_2 SN_2^*}{K_{S_2} + S} \frac{W}{W + 0.1A} - N_2^* \lambda + \alpha N_2 W, \quad (2.8)$$

where  $N_i$  denotes the concentration of microbe  $i$  in the lumen,  $N_i^*$  the concentration of microbe  $i$  that adheres to the wall,  $A$  the total wall sites,  $W = A - N_1^* - N_2^*$  the free wall sites,  $\lambda$  the rate of wall microbes moving into lumen, and  $\alpha$  the rate of lumen microbes adhering to the wall. By incorporating the wall attachment effect into the model, this is clearly a step forward in simulating the gut environment. It is noted that in the above model, the newly grown

wall-attached bacteria  $\frac{\mu_i SN_i^*}{K_{S_i} + S}$  are further divided into two subgroups, with one

group remaining on the wall and the other moving into the lumen. This treatment is questionable following a simple comparison between the magnitudes of the right-hand-side terms in the equation. The amount of *newly grown* bacteria coming

into the lumen  $\frac{\mu_i S N_i^*}{K_{S_i} + S} \frac{0.1A}{W + 0.1A}$  is an order smaller than the other term  $N_i^* \lambda$

which is proportional to the *total* number of wall-attached bacteria.

Freter et al. concluded that, in order to allow coexistence of many microbial species in the GI tract, there must be numerous nutrients such that each species has a competitive advantage over all other species for at least one specific type of nutrient. This conclusion may look odd based on today's common knowledge, but at the time, Freter et al.'s pioneering attempt did inspire a group of mathematicians to look into the mathematical aspect of the problem (Waltman (1984); Freedman et al. (1989)). These pure mathematical investigations focused on the stability and asymptotic properties of the solution to Eqns. (2.1-2.8) and other similar ordinary differential equations (ODE) encountered in mathematical biology. The associated results and conclusions are interesting in their own sense, but have limited practical implication to the understanding of gut microbial ecosystem. As an attempt to explain the coexistence phenomena widely observed in real-world microbial populations, Freedman et al. (1989) invented a time delay coefficient  $\tau_i$  to modify the Monod growth model (2.1-2.3) into

$$\frac{dS}{dt} = (S_0 - S)D - \frac{\mu_1}{y_1} \frac{S_{t-\tau_1} N_1}{K_{S_1} + S_{t-\tau_1}} - \frac{\mu_2}{y_2} \frac{S_{t-\tau_2} N_2}{K_{S_2} + S_{t-\tau_2}}, \quad (2.9)$$

$$\frac{dN_1}{dt} = \frac{\mu_1 S_{t-\tau_1} N_1}{K_{S_1} + S_{t-\tau_1}} - DN_1, \quad (2.10)$$

$$\frac{dN_2}{dt} = \frac{\mu_2 S_{t-\tau_2} N_2}{K_{S_2} + S_{t-\tau_2}} - DN_2. \quad (2.11)$$

where  $S_{t-\tau_i}$  denotes the concentration of nutrient at time  $t - \tau_i$ . After a long and tedious mathematical derivation, coexistence is proved to be one possibility of the modified model. But the result cannot be easily extended to the general case of multiple bacteria species competing on multiple nutrients. Also, the time-delay

assumption does not have any direct supporting evidence from *in vitro* or *in vivo* investigations.

### 2.4.3 Theoretical study of mathematical models

Mathematical/computational modelling of gut microbiota arose as a research topic in the 1980's, and it soon diverted into two research themes. One route focused on the theoretical aspect of mathematical models, and tried to show from the ODE model the existence and some general structure of a steady-state gut microbial ecosystem. The other route focused on computational modelling, i.e. to simulate using numerical programs the dynamic development of gut microbiota and their interactions with the host.

The theoretical research theme was driven mainly by a single research group led by Hal Smith at Arizona State University, USA. In a series of publications (Ballyk et al. (1998, 1999, 2001); Stemmons et al. (2000); Jones et al. (2000); Jones et al. (2002)), they presented mathematical studies of various simplified gut models including the plug flow model (Ballyk et al. (1998, 1999, 2001); Jones et al. (2000, 2002)), the chemostat model (Stemmons et al. 2000; Ballyk et al. 2001), the random motility effect (i.e. the diffusion effect) (Ballyk et al. (1998, 2001); Jones et al. (2002)), the wall attachment effect (Ballyk et al. (1999, 2001); Stemmons et al. (2000); Jones et al. (2000, 2002)). As it is hard to perform theoretical analysis for multiple bacteria species, it was assumed in all these studies that there were only two bacteria species competing against each other. The wall attachment model used in these studies is essentially the same as the model proposed by Freter (1983d), as summarized in Eqns. (2.4-2.8). Following the analogue of Brownian diffusion, the random motility of microbes was modelled with a diffusion term, and the hydraulic transport of nutrient  $S$  and microbes  $N_i$  were assumed to obey the following partial differential equations:



$$\frac{\partial S}{\partial t} = d_S \frac{\partial^2 S}{\partial x^2} - v \frac{\partial S}{\partial x} \quad (2.12)$$

$$\frac{\partial N_i}{\partial t} = d_N \frac{\partial^2 N_i}{\partial x^2} - v \frac{\partial N_i}{\partial x}, \quad (2.13)$$

where  $d_S$  and  $d_N$  are diffusion coefficients for nutrient and microbes respectively,  $v$  is the velocity of gut media, and  $x$  denotes the spatial coordinate along the GI tract. These assumptions are valid in the context of mathematics, but have little relevance to the real-world gut environment. In particular, due to the high viscosity of normal gut media, the diffusion effect (or random motility effect) in the GI tract is negligible in practice.

#### 2.4.4 Progress in computational modelling

The first piece of work on computational modelling of gut microbial ecosystem is perhaps Coleman et al. (1996). In this work, the chemostat model (2.1-2.3) was adopted, and a C program was coded to simulate the growth of 6 microbe groups competing on 5 nutrients (glucose, lactose, starch, sorbose and serine). Rather than being a conclusive study, this work demonstrated the feasibility of computational modeling in the investigation of human colonic ecosystem. Unfortunately, the authors did not continue their research after this.

The second notable computational study was reported by Michael Wilkinson (2002a, 2002b, 2002c). The gut was modelled as a rigid axisymmetric tube, and the spatial discretization was done using a heuristic finite difference scheme in the 3D space based on the rotational symmetry. The hydraulic transport was driven purely by diffusion caused by the concentration difference between neighboring finite difference sections. The microbial metabolism was based on the basic Monod model, with a series of ad hoc extensions to take into account toxin inactivation, symbiotic food interactions, binding site competition etc. This study was completely disconnected from *in vivo* trials or *in vitro* experiments, but the work marked a

notable effort towards building a comprehensive computer simulator for human gut microbial ecosystem. It should be noted that this model has some fundamental mistakes for both hydraulic transport and microbial metabolism. The GI tract is elastic not rigid, and the diffusion motion is negligible due to high viscosity of normal gut media. Despite of various additional terms, the growth model adopted by Wilkinson is essentially similar to Hansen et al. (1980) as illustrated in Eqns. (2.1-2.3), Freter (1983d) as illustrated in Eqns. (2.4-2.8), and Smith et al. (Ballyk et al. (1998, 1999, 2001); Stemmons et al. (2000); Jones et al. (2000, 2002)). As a result, steady-state coexistence of multiple bacteria is a rare event and unstable following this metabolic model.

Wilkinson's approach (2002a, 2002b, 2002c) contains a large number of parameters which are very difficult, if not impossible, to be determined from experiments. Hence, de Jong et al. (2007) moved back to the simple chemostat model as in Eqns. (2.1-2.3), and designed a relative simple simulation framework incorporating both small and large intestines. They demonstrated how to interpret *in vivo* experimental data using the simulation-based approximation.

More recently, Munoz-Tamayo et al. (2010, 2011) simulated the human large intestine using three pairs of chemostat models connected to each other, representing the ascending, the transverse, and the descending colon respectively. Each section of the GI tract is represented by two chemostats, representing the lumen and the mucus layer respectively. Modelling the mucus layer in the same way as the lumen space is fundamentally different from the previous wall attachment models (e.g. Freter 1983d), where the mucus layer is assumed static. Justification of such a treatment has not been presented by Munoz-Tamayo et al. (2010, 2011). The other contribution made in their work is the classification of functional groups for the gut microbiota and the associated fermentation pathways. Very recently, Lawson et al. (2011) presented a statistical estimation method to help determine the parameters of their gut model. They modelled the GI tract as a chemostat and similar to Munoz-Tamayo et al. (2010, 2011), they also treated the gut microbiota at the functional level.

---

### 2.4.5 A comparison summary

To give a clear global picture for the mathematical / computational study of gut microbial ecosystem, the related research works are compared in Table 2.2. The research field has continuously attracted researchers from both biological and mathematical backgrounds. However, due to the high complexity of the gut microbial ecosystem and the advanced mathematical / computational skills it requires, no researcher has been able to stay long and make continuous progress along this research direction. Overall, the progress in this theme of research has been very limited and many fundamental problems remain outstanding.

Table 2.2 Mathematical / computational modelling of gut microbial ecosystem

	<b>Freter et al.</b>	<b>Smith et al.</b>	<b>Coleman et al.</b>	<b>Wilkinson</b>	<b>de Jong et al.</b>	<b>Tamayo et al.</b>	<b>Lawson et al.</b>
<b>Date</b>	1983	1998- 2002	1996	2002	2007	2010- 2011	2011
<b>Theoretical analysis</b>	Y	Y	N	N	N	N	N
<b>Computational Simulation</b>	N	N	Y	Y	Y	Y	Y
<b>Chemostat</b>	Y	Y	Y	N	Y	Y	Y
<b>Plug flow</b>	N	Y	N	Y	N	N	N
<b>Monod growth model</b>	Y	Y	Y	Y	Y	Y	Y
<b>Wall attachment / mucus layer</b>	Y	Y	N	Y	N	Y	N
<b>Multiple species (&gt;2)</b>	N	N	Y	Y	Y	Y	Y
<b>Multiple substrates (&gt;1)</b>	N	N	Y	Y	Y	Y	Y

## Chapter 3 Human Colon

### Abstract

The human colon is a highly dynamic anaerobic ecosystem in the gastrointestinal (GI) tract. The main function of the human colon is absorption and excretion. However, the complex microbiota in the human colon is recognized as a key component in GI tract homeostasis, and both the composition and metabolism of the gut microbiota are strongly related to human health and disease. To make the thesis self-contained and more accessible by engineers and mathematicians who are not necessarily familiar with gut microbiology, this Chapter summarizes some background knowledge of the human colon, including the physiology and anatomy, microbiota composition and metabolism of human colonic microbiota. The concepts of probiotic, prebiotic and synbiotics are also introduced in this Chapter.

### 3.1 A short overview

The human colon (also called large intestine) is a highly dynamic anaerobic ecosystem in the gastrointestinal (GI) tract. Until the 80's, the classical view of the human colon is an organ which absorbs salt and water and provides a mechanism for the orderly disposal of waste products or digestion. It is now clear, however, that it has a major role (Table 3.1) in digestion to salvage energy from carbohydrate and protein not digested in the upper intestine (Macfarlane et al., 1991). This is achieved by the metabolism of anaerobic bacteria and is known as fermentation. A brief description of this ecosystem is presented below.

Table 3.1: Major functions of the human large intestine

Process	Products
Digestive	
Carbohydrate fermentation	Short chain fatty acid (SCFA); H <sub>2</sub> , CO <sub>2</sub> , CH <sub>4</sub> ;
Protein breakdown and amino acid fermentation	Biomass Short chain fatty acid (SCFA); S <sub>f</sub> H <sub>2</sub> , CO <sub>2</sub> , CH <sub>4</sub> ; B <sub>f</sub> Biomass H <sub>f</sub> P <sub>f</sub> Short chain fatty acid; Branched chain fatty acid;
Absorptive	A <sub>f</sub> H <sub>2</sub> , CO <sub>2</sub> ; N <sub>f</sub> Phenols, Amines, Ammonia B <sub>f</sub>
Excretory	All the above except biomass; B <sub>f</sub> Na, K, Cl, HCO <sub>3</sub> , H <sub>2</sub> O; F <sub>c</sub> Bile acids E <sub>f</sub> Biomass; M <sub>f</sub> Food residues; H <sub>f</sub> Epithelial cells; T <sub>c</sub> Mucus;
Hormonal	N <sub>f</sub> H <sub>2</sub> O, H <sub>2</sub> , CO <sub>2</sub> , CH <sub>4</sub> ; E <sub>f</sub> Toxic waste Somatostatin
Synthetic	Vitamin B and K
Storage	For control of defaecation

Metabolic (bacteria)	Bile acid dehydroxylation; Sulphate → Sulphide; Nitrate → Nitrite → Ammonia; Many other hydrolytic and reductive reactions
----------------------	---

---

### 3.2 Physiology and anatomy

The human colon lies with loops and flexures through the pelvis in the abdominal cavity. Cummings et al. (1980) studied the large intestine of 46 sudden death victims from both Africa and the UK, the large bowel was 154 cm (113-207 cm) in length and had a surface area of 1,274 cm<sup>2</sup> (731-2,509 cm<sup>2</sup>). The main function of the colon is absorption. It absorbs over 90% of the contents passing through it, reducing them from 1 or 2 liters of thick fluid to about 250 ml of semi-solid faecal matter. The faeces contain 75% water and the remainder is solid material, of which 30% consists of bacteria and other matter (food residues and desquamated mucosal cells). The GI tract normally contains about 200 ml of air including carbon dioxide, hydrogen and methane which is produced by normal bacterial flora from intestinal contents. The socially unacceptable component of flatus mainly includes hydrogen sulphide, ammonia, volatile amino and fatty acids. A more detailed description on the composition in the GI tract can be found in Cheshire et al. (1997).

The human colon is a unique biochemical environment which is characterized by low redox potential and controlled at 37°C (Mackie et al. (1999); Savage (1977)). The human colon consists of four sections: the ascending colon, the transverse colon, the descending colon, and the sigmoid colon (the proximal colon is usually referred to as the caecum and ascending colon, and the distal colon is usually referred to as the descending colon, the sigmoid colon and rectum). The caecum, colon, rectum and anal canal make up the large intestine (Figure 3.1). Mouth to anus transit through the human gut takes about 60 h in UK adults with women 72 h and men 55 h, of this 4-6 h will be mouth to caecum transit times so residence in the colon is around 54 h (Cummings et al., 1992). Transit in Africans is reported to be much quicker in the region of 24 to 48 hours (Burkitt et al., 1972). The volumes of the anatomical regions

---

of the colon have been calculated based on the dimensions in the literature (Table 3.2) (De Jong et al. (2007); Rajilic-Stojanovic (2007)).

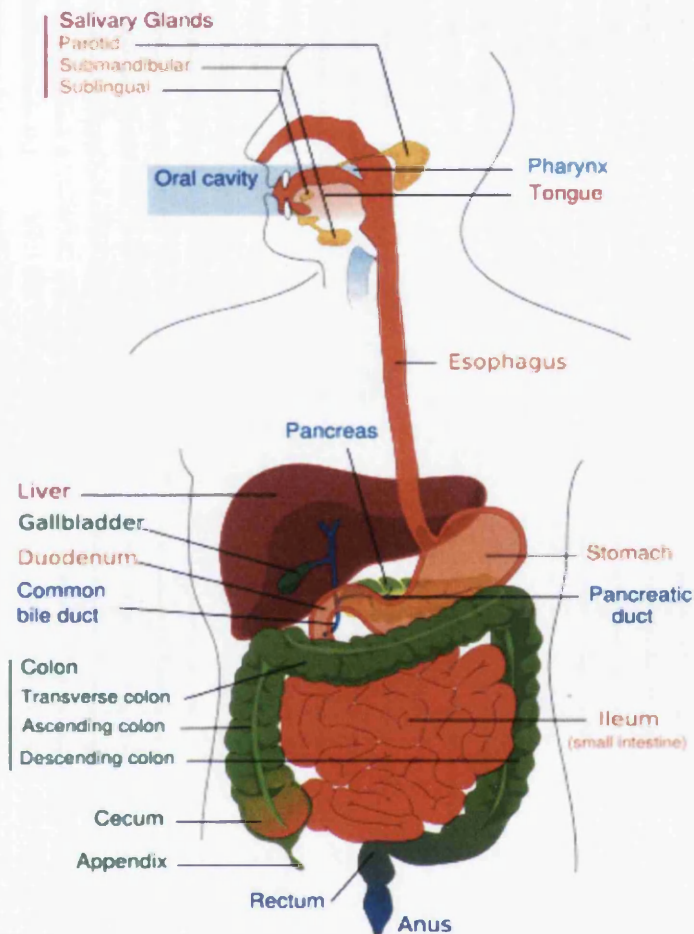

Figure 3.1: Representation of the human GI tract (Source: Wikipedia)

The colon receives the undigested food material from the ileum and passes the digesta to the proximal and distal colon and then excretes from the rectum. The passage of the digesta takes place in the intestinal lumen by peristaltic movements. During this travel, the digesta such as carbohydrates and protein not digested in the upper gut has been fermented by anaerobic bacteria (Minekus 1999). The principle fermentation products (e.g. short-chain fatty acid) confer a spatial distribution of metabolites and a pH profile with values of about 5.5 in the ascending colon, 6.2 in the transverse colon and 6.9 in the descending colon (Macfarlane et al., 1991). Intestinal contents move relatively slowly through the colon so that it allows time for

water and sodium to be absorbed. The rate of movement is about 5-10 cm/hour in the proximal colon (Cheshire et al., 1997).

Table 3.2: Approximate dimensions of the human colon

Anatomical region		Length (cm)	Volume of lumen Microhabitat (l)	Volume of mucus* Microhabitat (l)
Proximal colon	Cecum	6	0.41	0.017
	Ascending colon	15		
Transverse colon		50	0.98	0.042
Distal colon		25	1.63	0.070
	Sigmoid colon	40		
	Rectum	18		
Total		154	3.02	0.129

\* The volume of the mucus  $V_m$  is calculated assuming a perfect cylinder shape as  $V_m = 0.25\pi(\phi^2 - (\phi - 2 * e_m)^2)L$ . The thickness of the mucus  $e_m$  is taken to be approximately equal to 0.0830 cm;  $\phi$  is the diameter of the colon (5 cm), and L is the length of each section. The volume of the lumen is calculated as  $0.25\pi\phi^2L - V_m$ .

The intestine is lined with the epithelium which is specialized for mucous secretion, salt and water absorption. A mucus gel layer that is bound to the surface of the colonic epithelium can be partitioned into an inner layer and a sloppy outer layer (Matsuo et al. (1997); Atuma et al. (2001)). The outer layer with soluble mucus is quite viscous but mixes with the luminal juice. The soluble mucus allows easy movement of solid material in the lumen and acts primarily as a lubricant. This helps to prevent damage to the underlying epithelial cells (Allen et al., 1985). The inner layer is a shear-resistant gel that provides a stable protective barrier by keeping the microbes and toxins at bay, on the outer mucosal surfaces (Allen et al., 1985). Mucus thickness varies from 26 $\mu$ m to 300 $\mu$ m (Lichtenberger (1995); Matsuo et al. (1997); Pearson et al. (2005); Swidsinski et al. (2007)).



---

### 3.3 Human colonic microbiota

The normal microbiota of humans is an extensive and diverse microbial community, which is composed primarily of bacteria from numerous phylogenetic clusters (Simon et al. (1984); Macfarlane et al. (1991); Tannock (1995); Mitsuoka (1996); Hooper et al. (2002); Clemente et al. (2012)). The gastrointestinal (GI) tract of humans can be divided into three anatomical regions, namely, the stomach, small intestine (comprising duodenum, jejunum, and ileum) and large intestine or colon. The short transit time, acidic pH, secretion of bile and pancreatic juice of the upper GI tract restrict the levels of microbial colonization of this region (Holzapfel et al., 1998). Bacterial population levels in the stomach and the upper two-thirds of the small intestine are  $10^2$ - $10^4$  bacterial cells per milliliter of contents such as some aciduric Gram-positive bacteria (lactobacilli and streptococci) (Tannock et al., 1995). The flow of digesta is somewhat slower in the distal part of the small intestine (ileum), and conditions are thus more favorable for microbial colonization. Bacterial concentrations are  $10^6$ - $10^8$  bacterial cells per milliliter of contents and usually contain bacteria similar to those found in the colon (Evaldson et al., 1982). A higher diversity of micro-organisms, with the presence of Gram-negative facultative anaerobic bacteria (such as members of the family *Enterobacteriaceae*) and obligate anaerobes (including *Bacteroides*, *Veillonella*, *Fusobacterium* and *Clostridium* species) in conjunction with lactobacilli and enterococci are normally predominant in the ileum (Simon et al. (1984); Tannock (1995); Holzapfel et al. (1998)).

The human colon has a more neutral environment and a relative abundance of nutrients including carbohydrates and protein not digested in the upper GI tract, sloughed off epithelial cells and microbial cell debris. The major component of colonic contents is bacteria whose numbers exceed  $10^{10}$ - $10^{12}$  bacterial cells per gram of contents (Tannock et al. (1995); Holzapfel et al. (1998); Guarner et al. (2003)). Several hundred species have been identified, but 30-40 species belonging to 5 or 6 genera account for 99% of biomass based on traditional culture dependent testing methods (Finegold 1983). The gut microbiome is dominated by only 2 bacterial

---

divisions, Firmicutes and Bacteroidetes, which make up over 90% of the intestinal microbiota. The remainder consists of Actinobacteria (Turnbaugh et al., 2009a) and, to lesser extent Proteobacteria, Verrucomicrobia, and Cyanobacteria (Backhed et al. (2005); Ley et al. (2006)). Furthermore, only two archaeal species have been described with *Methanobrevibacter smithii* being more predominant than *Methanosphaera stadtmanae* (Eckburg et al. (2005); Mihajlovski et al. (2008)). Minor populations of *Eukarya* have been recently reported (Scanlan et al., 2008). Viruses and bacteriophages are also found in the human large intestine (Breitbart et al. (2003); Lepage et al. (2008)). The majority of members of the colonic microbiota are obligate anaerobic genera, including *Bacteroides*, *Bifidobacterium*, *Clostridium*, *Enterococcus*, *Eubacterium*, *Fusobacterium*, *Peptococcus*, *Peptostreptococcus* and *Ruminococcus* (Macfarlane et al. (1991); Tannock (1995); Suau A et al. (1999)). Table 3.3 lists bacteria commonly isolated from the human colon (Macfarlane et al., 1995).

Table 3.3: Bacteria, their substrates and products in the human large intestine

Bacteria	Description	Number		Substrate	Fermentation products
		Log 10/g dry wt faeces	Mean Range		
Bacteroides	G- rods	11.3	9.2-13.5	Saccharolytic	A, P, S
Eubacteria	G+rods	10.7	5.0-13.3	Saccharolytic, some amino acid fermenting species	A, B, L
Bifidobacteria	G+rods	10.2	4.9-13.4	Saccharolytic	A, L, f, e
Clostridia	G+rods	9.8	3.3-13.1	Saccharolytic and amino acid fermenting species	A, P, B, L, e
Lactobacilli	G+rods	9.6	3.6-12.5	Saccharolytic	L
Ruminococci	G+cocci	10.2	4.6-12.8	Saccharolytic	A
Peptostreptococci	G+cocci	10.1	3.8-12.6	As for the clostridia	A,L

Peptococci	G+cocci	10.0	5.1-12.9	Amino acid fermenters	A, B, L
Methanobrevibacter	G+cocco bacilli	8.8	7.0-10.5	Chemolithotrophic	CH <sub>4</sub>
Desulphovibrios	G- rods	8.4	5.2-10.9	Various	A
Propionibacteria	G+rods	9.4	4.3-12.0	Saccharolytic, lactate fermenting	A, P
Actinomyces	G+rods	9.2	5.7-11.1	Saccharolytic	A, L, S
Streptococci	G+cocci	8.9	3.9-12.9	Carbohydrate and amino acid fermenting	L, A
Fusobacteria	G- rods	8.4	5.1-11.0	Amino acid fermentation carbohydrate also assimilated	B, A, L
Escherichia	G- rods	8.6	3.9-12.3	As for streptococci	Mixed acids

A= acetate; P = propionate; B = butyrate; L= lactate; f = formate; e = ethanol; S = succinate

The human colonic microbiota is mainly located in lumen and mucus. The bacteria that colonize the gut must be able to proliferate at a rate that resists washout. Adherence to the intestinal mucosal surface is an important factor in intestinal bacterial colonization. The mucus gel mainly consists of water (95%) and mucins, which are mostly of glycoproteins and serves as a lubricant and a protective lining over the mucosa (Laux et al. (2005); Pearson et al. (2005)). The main structural components of the mucus layer are the mucins or glycoprotein which is a carbon source that can support intestinal bacteria *in vivo* in the absence of any dietary input (Macfarlane et al., 1991). Furthermore, under the mucus the surfaces of intestinal epithelial cells are covered with an abundance of terminally fucosylated glycoproteins and glycolipids which are induced by members of the intestinal microbiota (Bry et al., 1996). In particular, bacterial species such as *Bacteriodes thetaiotaomicron* can turn to host glycans for use as an energy source when dietary polysaccharides become scarce (Sonnenburg et al., 2005). This commensal microbe

are modulated by the host with its requirement needs, which gives it a competitive colonization advantage within the intestinal niche (Hooper et al., 1999). Thus the interaction of microorganisms with the mucosa is a complex one, which involves cross-talk between the microbes, and between the microbes and the host (Chow et al., 2006).

In terms of the bacterial species presence, the predominant mucosa-associated population is host specific and uniformly distributed along the colon but significantly distinct from the lumen and faeces (Zoetendal et al. (2002); Eckburg et al. (2005)). The different fermentation profiles are also exhibited between planktonic bacteria of the lumen and sessile (biofilm) bacteria growing in close association with host cells (Probert et al., 2002). *In vitro* studies with biofilm chemostats in series showed that biofilm bacteria made the principle contribution to acetate production, while non-adherent planktonic bacteria were largely responsible for the majority of propionate and butyrate formation (Macfarlane et al., 2005). The species composition of the human intestinal microbiota differs between particle-associated and free-living communities (Walker et al., 2008). Their functional differences have also been suggested (Macfarlane et al. (1997, 2006b)).

Some researchers focused on lactobacilli (e.g. *L. gasseri*) as general mucosa-associated bacteria because of their potential probiotic effects in the human GI tract (Zoetendal et al., 2002). Some lactobacilli, administered as probiotics, temporarily colonize the mucosal surface and displace other microorganisms. Administration of 19 test strains of lactobacilli (each  $5 \times 10^6$  cfu/ml) fed to healthy volunteers in 100 ml fermented oatmeal soup, high numbers of adherent lactobacilli were still recovered from jejuna samples up to 11 days after administration of the bacteria had stopped, while clostridia numbers decreased between 10- and 100-fold in some of the volunteers (Johansson et al., 1993). *Lactobacillus plantarum* was the predominant adherent species, but *L. agilis*, *L. reuteri* and *L. casei* subsp. *rhamnosus* were also present (Johansson et al., 1993).

The diversity of the human gastrointestinal microbiota can be obtained from cultivation-based and molecular studies. Culture based techniques that use differential media to select specific populations of bacteria are cost-effective and reproducible. However, species or strain level detection is very difficult as the culture based analysis is limited to distinguishing between different bacterial phylogenetic groups (Sekirov et al., 2010). Modern molecular method such as 16S ribosomal RNA clone libraries indicates that the number of species will be even higher. The advent of molecular techniques based on 16S rRNA gene analysis is allowing a more complete assessment of this complex microbiota ecosystem by unraveling the extent of the diversity, abundance and population dynamic of this community (Vaughan et al. (2000); Zoetendal et al. (2004)). The microbial diversity in the human colon is estimated as about 1,000 species based on molecular techniques (Rajilic-Stojanovic et al., 2007). Taking into account inter-individual variability, the composition of microbial consortium in the lower human GI tract may be over 45,000 bacterial species (Frank et al., 2007). Table 3.4 shows an overview of some current methods used to investigate the intestinal microbiota (Fouhy et al. (2012b); Amor et al. (2006)).

Table 3.4: Various Methods for investigating the diversity of the human intestinal microbiota

<b>Method</b>	<b>Application</b>	<b>Comments</b>
Culturing	Isolation of pure cultures, enumeration	Not representative for microbiota; insufficient selective media; time consuming
16S rRNA gene libraries and sequencing	Identification and phylogeny	Large scale cloning is laborious; primer bias can be an issue
Dot-blot hybridization	Detection, quantification and activity	Gives information about activity of microbiota; of rRNA; comprehensive set of probes published
FISH	Single cell detection and enumeration	High throughput with image analysis software and flow cytometry; requires probe design comprehensive set of probes published

PCR-DGGE/TGGE	Rapid profiling of total microbiota	Detection of specific groups possible; semi-quantitative identification by band extraction and sequencing
T-RFLP	Rapid profiling of total microbiota	Identification by cloning and sequencing; bank of T-RF under construction
Quantitative real time PRC	Detection and quantification	Requires probe/primers design; very high throughput
High through-put sequencing	Rapid identify bacterial profile in complex environments	Sequencing based approaches e.g., 454, Illumina, SoLID, Ion torrent

Abbreviations: DGGE, denaturing gradient gel electrophoresis; FISH, fluorescent in situ hybridization; PCR, polymerase chain reaction; rRNA, ribosomal ribonucleic acid; TGGE, temperature gradient gel electrophoresis; T-RF, terminal restriction fragment; T-RFLP, terminal restriction fragment length polymorphism. SoLID, sequencing by oligonucleotide ligation and detection.

The diversity and composition of the human intestinal microbiota promotes our knowledge of the identities of the microbial inhabitants, but it does little to tell us about the metabolic function of community members in the ecosystem. Combination of composition and function contributions of gut microbial communities to their host will provide a complete view of the ecology and functional capacity of the gut microbiome (Lozupone et al. (2012); Sekirov et al. (2010)). However, due to the complexity of the human colonic microbiota, it is very difficult to elucidate the function of microorganisms. The ‘Meta’ family of function-focused analyses including metagenomics, metaproteomics, metabolomics and metatranscriptomics have greatly improved our understanding of bacterial functionality in the human microbiota ecosystem (Tyson et al. (2004); Gill et al. (2006); Gloux et al. (2007) Kurokawa et al. (2007); Zoetendal et al. (2008); Verberkmoes et al. (2009); Wikoff et al. (2009); Brugere et al. (2009); Mahowald et al. (2009)). Metagenomics gives sequence information from the collective genomes of the microbiota, which can be used to identify the functional contributions and biological roles of the microbial

ecosystem residing in the human large intestine. More information related to the 'Meta' family analyses can be found in the review paper by Sekirov et al. (2010).

Today, the complex human microbiota is recognized as a key component in GI tract homeostasis, and both the composition and metabolism of the gut microbiota are strongly diet related (Flint et al., 2007). Major functions of the gut microbiota include metabolic activities in salvage of energy and absorbable nutrients, important trophic functions on intestinal epithelial cells and on the immune system, and protection of the colonized host against invasion pathogens (Guarner et al., 2003). The major metabolic function of colonic microbiota is the fermentation of non-digestible dietary residue and dislodged mucus produced by the epithelia (Roberfroid et al., 1995). The metabolic endpoint of non-digestible carbohydrate is generation of short chain fatty acid (SCFA) which is a major source of energy in the colon (Cummings et al., 1996). Anaerobic metabolism of peptides and proteins also produce SCFA and other potentially toxic substances including ammonia, amines, phenols, thiols and indols (Macfarlane et al. (1986a); Smith et al. (1996)). Colonic microorganisms also play a part in essential vitamin synthesis and absorption of minerals such as calcium, magnesium and iron (Hill (1997); Younes et al. (2001)).

One of the trophic functions of gut flora is to control epithelial cell proliferation and differentiation. All major SCFA stimulate epithelial cell proliferation and differentiation in the large and small intestine *in vivo* (Frankel et al., 1994). However, butyrate inhibits epithelial cell proliferation and stimulates cell differentiation *in vitro* (Gibson et al., 1992). Another trophic function of gut flora is the development and homeostasis of the host immune system (Guarner et al., 2003). The interactions between the intestinal microflora and epithelial cells at the intestinal mucosal interface seem to play a part in the development of a competent immune system. The interesting observation is that the gut microbiota can act on the production of epithelial glycoconjugates, which may serve as receptors for attachment of pathogen (Salminen et al., 1998).

Protection against pathogens is also a main function of gut flora. Resident bacteria provide an important line of resistance to colonization by exogenous microorganisms and prevent pathogens invasion. Germ-free animals are very susceptible to infection (Taguchi et al., 2002). Several mechanisms leading to the barrier effect include attachment sites competition, nutrient competition and antimicrobial substance production. Attachment of some pathogenic bacteria can be prevented by the mutually beneficial crosstalk between the indigenous microbiota and the epithelial cells (Umesaki 1989). The symbiotic relationship between the host and bacteria prevents overproduction of the nutrient, which would favor the potential pathogen for the host (Hooper et al., 1999). Microbiota in the GI tract also can inhibit the growth of their competitors by producing antimicrobial substance such as bacteriocins (Brook (1999); Lievin et al. (2000)).

### **3.4 Metabolism of human colonic microbiota**

The main function for the microbiota in the colon is the breakdown of carbohydrate and protein that escape the digestion in the upper digestive tract or are produced by the host. The predominant anaerobes in the colon do not use oxygen as a terminal electron acceptor, and derive their energy from anaerobic respiration or substrate level phosphorylation (Goldin et al., 2006). Most of the bacterial reaction can be classified as reductive, hydrolytic or removal of functional groups such as dehydroxylation and decarboxylation which are often catalyzed by specific bacterial enzymes (Goldin et al., 2006). The major balance of the intestinal microbiota derives from the ability to convert the substrates into the energy, SCFA, biomass, CO<sub>2</sub>, H<sub>2</sub>, and CH<sub>4</sub> in some individuals (Nicholson, et al. (2012); Cummings et al. (1991)). The principle fermentation of carbohydrate and protein are summarized in Figure 3.2 and Figure 3.3 (Cummings et al., 1991).



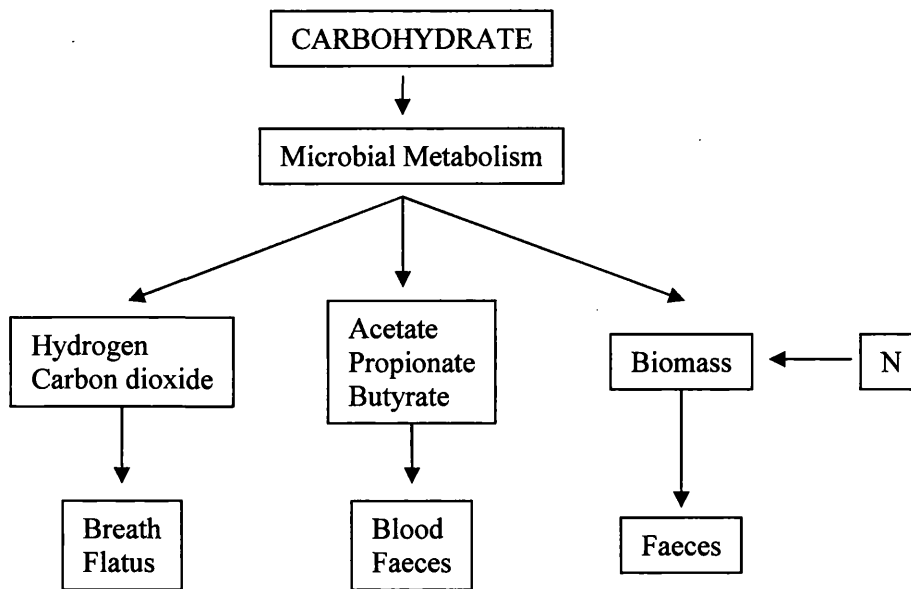

Figure 3.2: Carbohydrate fermentation in the human large intestine

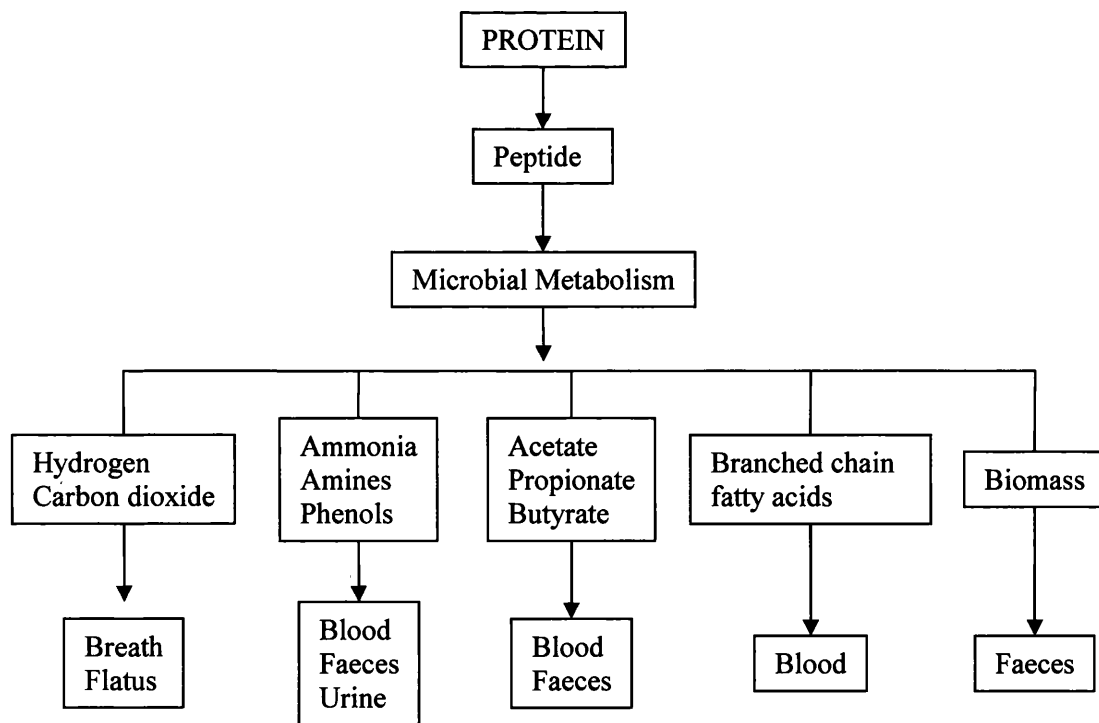

Figure 3.3: Protein breakdown and amino acid fermentation in the human large intestine

### 3.4.1 Regional difference

There are differences between the caecum and sigmoid colon in the concentrations of SCFA, moisture and pH. SCFA concentrations are highest in the caecum and ascending colon and fall towards the descending colon. In contrast, pH is lowest in the ascending colon (pH 5.4-5.9) and rises in the descending colon (pH 6.6-6.9). The fermentation in the caecum and right side of the colon is mainly SCFA. The left side of the colon is more carbohydrate depleted, and protein breakdown and amino acid fermentation become more dominant. Branched-chain fatty acids are also accumulated along with phenols and amines in the descending colon, and the characteristics of the flora change towards a more methanogenic and sulphate-reducing type of flora. These contrasts are summarized in Figure 3.4 (Cummings et al., 1991).

#### Ascending colon

Carbohydrate rich  
Moisture rich  
SCFA increase  
pH acid (pH 5-6)  
Residence time 6-16 h  
Bacterial growth fast  
Mainly H<sub>2</sub> and CO<sub>2</sub>

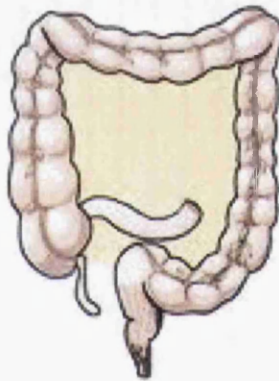

#### Descending colon

Protein rich  
Less free water  
SCFA less  
pH near neutral  
Residence time 12-36 h  
Bacterial growth slower  
H<sub>2</sub>, CO<sub>2</sub> and CH<sub>4</sub>  
Amines, phenols and ammonia

Figure 3.4: Regional differences in large bowel function in the human.

The human large intestine is a fermentative organ with substantial potential for water, electrolyte and organic anion absorption. The marked production and pH difference in different part of the colon may account for different disease activity. For example, ulcerative colitis is usually found in the rectum and spreads proximally, whilst diverticular disease is mainly a disorder of the sigmoid colon. About 60% of large bowel cancers lie within the rectum, sigmoid and descending colon (Cummings et al. (1987a, 1987c)).

### 3.4.2 Carbohydrate and protein digestion

Carbohydrate fermentation and protein breakdown are the main metabolic pathway of the gut microbiota in the human colon. Fermentation is highly depending on the amount and type of substrate available to the bacteria. The major substrates for fermentation are shown in Table 3.5 (Cummings et al. (1987a, 1987b, 1989)), where the figures are based on people eating western style diets.

Table 3.5: Substrates available for fermentation in the human colon

Type		Amount (g/day)
Carbohydrate	Resistant starch (RS)	5-35
	Non starch polysaccharide (NSP)	10-25
	Oligosaccharides	2-8
	Sugars and Sugars alcohols	2-5
	Synthetic carbohydrate, e.g. lactulose, polydextrose, pyrodextrins, modified celluloses	Variable
Protein	Dietary (N * 6.25)	1-12
	Endogenous, e.g. pancreatic enzymes and other secretions	4-8
	Urea, nitrate	0.5
Other	Mucus (acidic glycoproteins)	3-5
	Bacterial recycling	Unknown
	Sloughed epithelial cells	30-50
	Organic acids	Variable
Total	Carbohydrate	20-60
	Protein	5-20

Carbohydrates are polyhydroxyaldehydes and ketones that have the empirical formula  $(\text{CH}_2\text{O})_n$ . Carbohydrates provide 85% of available substrates for colonic microbiota fermentation. From nutritional point, dietary carbohydrates are classified

primarily according to the degree of polymerization with subdivisions based on glycosidic linkages and chemistry of individual sugars. Table 3.6 shows such a classification, which provides a logical approach to food carbohydrate (Englyst et al., 1992). Main dietary carbohydrates that escaped digestion and absorption in the small intestine are resistant starch (RS) and non-starch polysaccharides (NSP).

Table 3.6: Classification of dietary carbohydrates

Group	DP*	Sub-group		Digestion in the small intestine
Sugars	1	Monosaccharides	Glucose, fructose, Galactose, sorbitol, mannitol	Well absorbed except sugar alcohols
	2	Disaccharides	Sucrose, Lactose, Maltose	Well absorbed except lactose
Oligosaccharides	3-9	$\alpha$ -glucans	Mostly starch hydrolysis products	Well digested
		Non- $\alpha$ -glucans (NDO)	Fructo-oligosaccharides; Galacto-oligosaccharides; Raffinose, Starchyose, Polydextrose	Probably all reach the caecum
Polysaccharides	$\geq 10$	Starch ( $\alpha$ -glucans)	Amylose, Amylopectin	Some forms of resistant starches (RS) reach the caecum
		Non-starch polysaccharides (Non- $\alpha$ -glucans)	Cell wall, Cellulose, Hemicellulose, Pectins, Guar, inulin, etc.	All reach the caecum

\* Degree of polymerisation.

Non-starch polysaccharides (NSP) are the major polysaccharide group to be fermented in the human colon. They are characterized as being non- $\alpha$ -glucan or non-starch polysaccharides and comprise a diverse group of homo and heteropolymers,

including xyloglucans, glucomannan, arabinoxylans and xylans etc. (Chassard et al., 2007). A number of physico-chemical factors affect fermentability of NSP include the extent of lignifications of the cell wall polymers, water solubility and particle size of substance (Adiotomre et al. (1990); Southgate et al. (1990)). For example, the more water soluble a substrate is the more highly digestible it is (Stephen et al., 1979). Similarly, the fine particle sizes of foodstuffs are easy for breakdown (Heller et al., 1980). NSP is the major component of dietary fibre which is involved in the production of beneficial compounds during the fermentation in the human colon to increase bulk, soften stool, and shorten transit time through the intestinal tract. The proposed health benefits of NSP are summarised in Table 3.7 (Adiotomre et al. (1990); Southgate et al. (1990)).

Table 3.7: Physiological properties and proposed health benefits of non-starch polysaccharides

<b>Physiological property</b>	<b>Health benefit for</b>	<b>Other major contributing dietary factors</b>
Increased satiety	Obesity	Total energy, fat
Delayed glucose absorption and reduced insulin secretion	Diabetes, Ageing	Starch
Reduced deoxycholate in bile	Gallstones	Fat, total energy, other carbohydrates
Low blood cholesterol	Coronary heart disease	Fat, cholesterol, antioxidants
Fermentation	Large bowel cancer	Other non-absorbed carbohydrate, fat, meat
Laxation	Constipation, diverticular disease, anal conditions, irritable bowel	Other non-absorbed carbohydrate, protein degradation products

However, the amount of resistant starch (RS) may exceed the amount of NSP on a high starch diet (Macfarlane et al., 1991). RS is calculated as the starch not hydrolyzed after 120 min incubation. RS in food items have shown figures from 3 to 6 g/d of daily RS intake in 10 different countries (Dysseler et al, 1994). However, in

countries where starch rich foods form the main source of energy intake are probably considerably higher (Cummings et al., 1991).

Oligosaccharides are carbohydrates with a degree of polymerization (DP) of 3-10 (Southgate 1995). They are readily soluble in water and can be fermented by the colonic microflora. Fructo-oligosaccharides (FOS) and galacto-oligosaccharides (GOS) have aroused interest in recent years, mostly because of their most important property, which may be unique, is to stimulate bifidobacterial growth specifically while suppressing the growth of some other species such as *Clostridium perfringens* (Gibson et al., 1995a). The fermentation products of FOS are mostly acetate and propionate with some butyrate and lactate, H<sub>2</sub> and CO<sub>2</sub>. The mechanism for the inhibition of clostridia growth is thought to be related to lowering of intestinal pH by bifidobacterial fermentation. FOS also affect lipid metabolism, reducing triglyceride and cholesterol concentrations in rats and diabetic humans (Yamashita et al. (1984); Fiordaliso et al. (1995)). Table 3.8 summarizes the health benefits of oligosaccharides (Yamashita et al. (1984); Roberfroid (1993); Fiordaliso et al. (1995); Kok et al. (1996)).

Table 3.8: Potential health benefits of oligosaccharides

<b>Health benefits of oligosaccharides</b>
Substrates for fermentation
Short-chain fatty acid production
Biomass (laxative effect)
Reduced nitrogenous end products in colon (ammonia, amines)
Selective stimulation of bifidobacteria
Protection against invading pathogens
Suppression of growth of clostridia and coliforms
Lipid metabolism
Decrease in triglyceride synthesis
Stimulate immune function

Several sources of nitrogen containing compounds that enter the large intestine are important substrates for metabolic action by the intestinal microbiota. The sources

include undigested dietary protein, protein from epithelial cells, and digestive secretions including digestive enzymes, glycoprotein mucins, free amino acids, and peptides including those derived from a bacterial origin (McCartney et al., 2006). In addition, ammonia, urea and nitrate are found in the ileal effluent (McCartney et al., 2006). The amount of protein entering the large bowel can be partly deduced from studies of ileostomy subjects that 12-18 g of protein enters the caecum from the ileum per day (Chacko et al., 1988). On protein-free diets, about 1 g N/day is lost in ileostomy effluent and it rises to about 2 g N/day when normal food is taken (Gibson et al., 1976). The approximate relative amount of N is protein (48-51%), peptides (20-30%), urea/ammonia/nitrate (10-15%) and free amino acids (Chacko et al. (1988); Florin et al. (1990)). Protein comprises mainly pancreatic enzymes with normal food amino acid patterns in ileostomy effluent. In contrast, in the feces the nitrogen compounds are more than 50% of bacterial origin (Stephen et al., 1980). Therefore, although the balance of nitrogen is relatively maintained between the amounts of entering and leaving the large intestine, the nitrogen containing compounds in the colon can be utilized by intestinal microbiota and are converted into bacterial protein which is found in the feces as intact bacteria (McCartney et al., 2006).

### **3.4.3 Main fermentation pathways**

Microbial metabolism involves catabolic reactions and anabolic reactions which could yield energy and lead to bacterial growth. Anaerobic digestion yields lower energy compared with aerobic processes. This will force the microbial community to cooperate efficiently and obtain enough energy for survival (Schink 1997). Syntrophic association is such a cooperation which two metabolic types of microorganism depend on each other to degrade the given substrates. The fermentation products converted by one microorganism are utilized by another microbe to improve the overall substrates (Kleerebezem et al. (2000); Jackson et al. (2002)). Several books and literatures have introduced the metabolic pathways of anaerobic fermentation, and the main reaction pathways by the human colonic

---

---

microbiota are described below (Gottschalk (1988); Miller et al. (1996); Macfarlane et al. (1997); Bernalier et al. (1999); Goldin et al. (2006)).

### 3.4.3.1 Embden-Meyerhoff-Parnas pathway (EMP)

The Embden-Meyerhoff-Parnas (EMP) pathway has been identified as the most common pathway of glucose metabolism. However, alternative catabolic pathway such as the Entner-Doudoroff pathway, pentose and pentose phosphoketolase pathway can also be used to metabolise hexoses (Gottschalk 1988). EMP is a biochemical pathway for the breakdown of glucose into pyruvate. Glucose is broken down from a six carbon molecule to a three carbon derivative. The EMP pathway includes three stages. The first stage involves the conversion of glucose to fructose-1,6-bisphosphate. This phase utilizes energy from ATP. The second phase converts the fructose-1,6-bisphosphate product to pyruvate. Two molecules of pyruvate are formed by one molecule of hexoses, and  $\text{NAD}^+$  is reduced to NADH and four molecules of ATP are formed. There are a total of ten steps that make up the two stages of the EMP pathway. At this final stage, the NADH produced from  $\text{NAD}^+$  is oxidized back to  $\text{NAD}^+$  in order for EMP pathway to continue. The reaction of EMP is shown below.

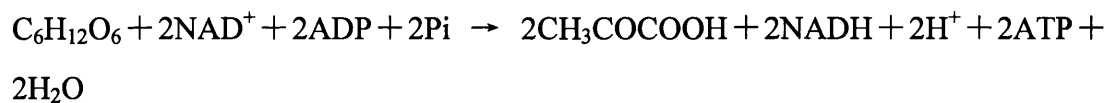

### 3.4.3.2 Pyruvate metabolism

Pyruvate is the central intermediate in fermentation that can be routed to various pathways. Pyruvate could be converted into formate, acetate, butyrate or ethanol via acetyl coenzyme A (acetyl-CoA) formation (Bernalier et al., 1999). Pyruvate can also be converted into propionate, valerate and caproate by a variety of anaerobic bacteria, either from glucose or lactate fermentation (Bernalier et al., 1999). The overall reactions of 3 main SCFA formations are shown below.

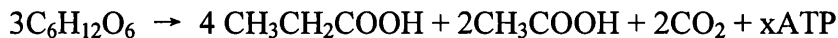

**Acetate formation:****Butyrate formation:****Propionate formation:**

Acetate is produced by many intestinal bacteria including *Ruminococcus* and *Propionibacterium*, and is the major acid product of nearly all species of *Bacteroides* (Wolin et al., 1994). *Fusobacterium*, *Eubacterium* and *Clostridium* spp. are major butyrate formers in the human intestine (Wolin et al., 1983). Propionate is formed by two different pathways i.e. through succinate, or direct reductive process involving formation of lactate and acrylyl-CoA (Miller et al., 1979). *Bacteroides* from the human colon are able to decarboxylate succinate to propionate (Miller et al., 1979). Valerate and/or caproate can be produced from pyruvate by some species of *Clostridium* or *Megasphaera* (Prins 1977).

A number of rumen and human studies attempt to draw up the equations for SCFA production through carbohydrate fermentation (Livesey et al. (1995); Wolin et al. (1981, 1983); Miller et al. (1979); Mathers et al. (1993)). The most valuable information needed to write an equation is the ratio of produced SCFA. Taking all available evidence into account including the probable metabolism of SCFA by the epithelium, a molar ratio of around 60:20:18 (acetate: propionate: butyrate) can be justifiably used and the stoichiometry is shown below (Mathers et al., 1993).

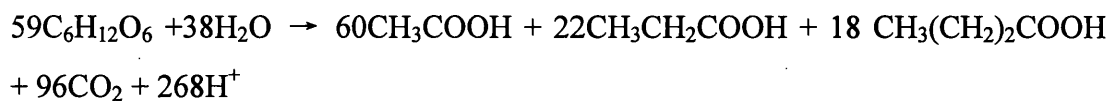

---

This stoichiometry gives a yield of SCFA from carbohydrate of 63 g SCFA/100g. This is close to the figure of 61 g SCFA/100g carbohydrate fermentation in the study of Livesey et al. (1995). However, a theoretical yield of SCFA (63 g SCFA/100g) is an upper limit for starch as a major substrate for fermentation (Macfarlane et al., 1986b). Plant wall polysaccharides such as arabinogalactans and pectins only give yields of 35-54 g SCFA/100g (Adiotomre et al. (1990); Englyst et al. (1987)). According to the above equation, 32-42 g of carbohydrate needs to be fermented in the human colon each day to produce 300-400 mmol SCFA (Titgemeyer et al., 1991).

### 3.4.3.3 Lactate formation and utilization

Many lactate-producing bacteria are present in the gut (*Bacteroides*, *Eubacterium*, *Clostridium*, *Streptococcus*, *Peptostreptococcus*, *Lactobacillus*, *Bifidobacterium*). There are two pathways of lactate production from pyruvate which involves producing two lactate isomers (D, L) (Gottschalk 1988). *Lactobacillus* spp. can produce D (-), DL or L (+) lactic acid, whereas *Bifidobacterium* and *Streptococcus* produce only the L (+) form (Bernalier et al., 1999). Lactate is generally produced by the homofermentative or heterofermentative pathway. The homofermentative pathway yields 2 mol of lactate per mol of glucose. The heterofermentative pathway yields one mole each of lactate, ethanol, CO<sub>2</sub> and ATP per mol of glucose. The overall reactions are shown below.

#### Homofermentative pathway:

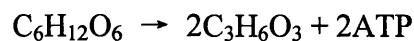

#### Heterofermentative pathway:



Bifidobacteria use a distinctive pathway that yields two moles of lactate, three moles acetate and five moles of ATP from two moles of glucose.

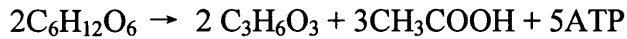

Lactate can be utilized by *Propionibacterium acnes*, *Veillonella* spp., *Megasphaera elsdenii*, *Clostridium* spp. and dissimilatory sulphate-reducers (Bernalier et al., 1999). It can be converted into acetate, propionate, butyrate and longer chain fatty acids. Lactate participates in a reversible reaction with pyruvate. In these conversions, lactate is oxidized to pyruvate and the corresponding pathways are those described above for pyruvate.

#### 3.4.3.4 Hydrogen formation and utilization

The total amount of gas produced each day from fermentation varies with values of 0.5-4 l/d which is mainly related to diet (Calloway et al. (1968); Flemings et al. (1983)). The average amount of hydrogen is around 19% in the total amount of gas (Levitt, 1971). In the colon, hydrogen can be formed by bacteria as a result of oxidation of pyruvate, formate, reduced pyridine nucleotides (NADH, NADPH) and reduced ferredoxins (Macfarlane et al., 2003). Hydrogen is used by three main routes in the human colon.

#### Methanogenesis

Human colonic methanogenic bacteria (MB) have been found only in 30-50% of healthy subjects in studies of Western populations (Fritz et al. (1985); Mckay et al. (1985)). Methanogenic bacteria in the large bowel have an obligate requirement for H<sub>2</sub>. Only two species, belonging to two different genera have been identified in the large intestine, namely *Methanobrevibacter smithii* and *Methanosphaera stadtmaniae* which carry out the conversion through two different pathways (Miller et al., 1986).

*Methanobrevibacter smithii* is the principal CH<sub>4</sub>-producing species found in human colon samples. It derives energy from the reduction of CO<sub>2</sub> with H<sub>2</sub>, according to the following equation (Miller et al. (1982, 1984, 1985, 1986)). H<sub>2</sub> and CO<sub>2</sub>, or formate, are the sole substrates.

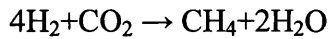

*Methanosphaera stadtmaniae* is also widespread species isolated from some faecal samples, yet consistently observed at lower population levels than *M. smithii*. This species combines methanol with H<sub>2</sub> as shown in the equation below (Miller et al. (1983, 1985)):

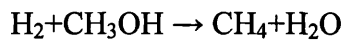

### **Sulphate reduction**

An alternative pathway for consumption of H<sub>2</sub> generated from colonic fermentation is through the activities of dissimilatory sulphate-reducing bacteria (SRB). The growth of SRB in the presence of sulphate, reducing it to sulphide, is the principle reaction of SRB. They utilize H<sub>2</sub> according to the equation:

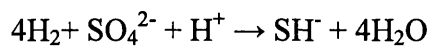

SRB can be found in the intestinal contents of humans and they are able to use gaseous hydrogen as an electron-donor for the reduction of sulphate to sulphide, and account for substantial consumption of hydrogen within the colon (Cummings et al., 1991). A three-stage continuous-culture study showed that SRB preferred to grow in the distal colon and confirmed *in vivo* at autopsy (Gibson et al. (1988a); Macfarlane et al. (1992b)). A review of the physiology and ecology of SRB showed that there is an inverse relationship between SO<sub>4</sub><sup>2-</sup> reduction and methanogenesis existing in the large bowel (Gibson 1990a). Mixing of SRB and methanogens in *in vitro* study demonstrated that colonic SRB were able to directly outcompete MB for the

---

available H<sub>2</sub> (Gibson et al., 1988b). Species belonging to the genera *Desulfovibrio* and *Desulfobulbus* are particularly efficient H<sub>2</sub> utilizing bacteria (Gibson et al., 1990b).

### Acetogenesis

The existence of other potential pathway of H<sub>2</sub> disposal by colonic bacteria is also known as reductive acetogenesis (Gibson et al., 1990b). Homoacetogenic bacteria could grow in the human colon. These organisms are able to combine 4 mol of H<sub>2</sub> with 2 mol of CO<sub>2</sub> to produce acetate in the equation below (Lajoie et al. (1988b); Durand et al. (1995)).



Bernalier et al. (1996a) have isolated a few species of genus *Clostridium* from faeces of five non-methanogenic subjects which have been identified as acetogenic strains and a new species of the genus *Ruminococcus*, named *R. hydrogenotrophicus* were also described in Bernalier et al. (1996b). However, acetogenesis is a less favorable route of hydrogen disposal than either sulphate reduction or methanogenesis and acetogenic bacteria under normal circumstances. Thus, significant levels of acetogenic activity would only be expected when conditions unfavorable for methanogenesis or sulphate reduction occur.

#### 3.4.3.5 Amino acids as substrates

Amino acid fermentation is also an additional source of SCFA in the human colon (Macfarlane et al., 1992a). Approximately 30% of protein is converted to SCFA. Protein breakdown could potentially account for about 17% of the SCFA found in the caecum, and 38% of the SCFA in the distal colon (Macfarlane et al., 1992b). There are five major bacterial pathways for amino acids breakdown including four direct pathways and one indirect pathway. The direct pathways include reduction resulting in saturated fatty acid production, oxidation resulting in the formation of

---

keto acids, hydrolysis causing the formation of an alpha-hydroxy fatty acid, and removal of the elements of ammonia, producing an unsaturated fatty acid (Rowland 1988). A fifth indirect pathway is carried out by clostridia to degrade amino acids in pairs and form a keto acid and a saturated fatty acid through a couple of redox reactions (Rowland 1988).

Reduction reactions are the major pathway for the breakdown of amino acids in the colon. The reduction products of colonic microorganisms include acetate, propionate, butyrate, and isobutyrate, isovalerate and 2-methylbutyrate (Kirjavainen et al., 1999). Other reduction products are ammonia, amines, CO<sub>2</sub> and H<sub>2</sub> (Mallett et al., 1998). Some products that result from reductive degradation of aromatic amino acids include phenol, p-cresol, phenylactic acid, phenylpropionate acid, indole, indoleacetic acid, and indolepropionine acid (Mallett et al., 1998).

Decarboxylation is a second major pathway for the degradation of amino acids (Clifford 1999). Bacterial decarboxylases act on amino acids to form amines and CO<sub>2</sub>. There are a number of intestinal bacteria containing decarboxylase activity including enterobacteria, enterococci, lactobacilli, clostridia, bacteroides, and bifidobacteria (Mallett et al., 1998).

### **3.5 The probiotic, prebiotic and synbiotics concepts**

Probiotic may be defines as 'living microorganisms which when administered in adequate amounts confer a health benefit on the host' (WHO 2002). Probiotics are non-pathogenic microorganisms which survive passage through the GI tract and are believed to have potential beneficial health effects. Many desirable characteristics of probiotic bacteria include being 'generally regarded as safe', having stability in gastric juices acid and bile salt, adherence to intestinal mucosa, persistence for certain time in the gut, having antagonism against pathogenic and putrefactive organisms and modulation of the immune response (Thomas et al. (2010); Dunne et al. (2001)). Probiotic activity to modulate the intestinal microbiota has been associated most commonly with lactobacilli and bifidobacteria. But other

---

non-pathogenic bacteria including species of streptococci and enterococci, non-pathogenic *E. coli* Nissle 1917, and the yeast *Saccharomyces boulardii* have been used (Soccol et al. (2010); Shanahan 2001). Table 3.8 lists microbes commonly used as probiotics (Dunne et al. (2001); Mack et al. (1999); Mattila-Sandholm et al. (1998); Ventura et al. (2002); Gardiner et al. (2002); Cummings (2009)).

Table 3.9: Organisms commonly used as probiotics in humans and animals

<b>Lactobacillus</b>	<b>Bifido-Bacterium</b>	<b>Other probiotic organisms</b>
<i>L. acidophilus</i>	<i>B. adolescentis</i>	<i>Enterococcus faecalis</i>
<i>L. brevis</i>	<i>B. animalis/lactis</i>	<i>Enterococcus faecium</i>
<i>L. casei</i>	<i>B. bifidum</i>	<i>Lactococcus cremoris</i>
<i>L. crispatus</i>	<i>B. breve</i>	<i>Lactococcus lactis</i>
<i>L. delbrueckii</i>	<i>B. infantis</i>	<i>Leuconostoc mesenteroides</i>
<i>L. fermentum</i>	<i>B. lactis</i>	<i>Pediococcus acidilactici</i>
<i>L. gallinarum</i>	<i>B. longum</i>	<i>Pediococcus pentosaceus</i>
<i>L. gasseri</i>	<i>B. thermophilum</i>	<i>Saccharomyces boulardii</i>
<i>L. johnsonii</i>		<i>Sporolactobacillus inulinus</i>
<i>L. lactis</i>		<i>Streptococcus thermophilus</i>
<i>L. paracasei</i>		
<i>L. plantarum</i>		
<i>L. reuteri</i>		
<i>L. rhamnosus</i>		

The effect of probiotics may be classified into three modes of action including modulating the host defences, preventing infections and restoration of the microbial equilibrium in the gut, affecting microbial products to inactive toxins and detoxification of host products (e.g. bile salts). Probiotics have been investigated in many clinical trials, including atopic disease in children, lactose intolerance, antibiotic-associated diarrhoea, traveler's diarrhoea, constipation, irritable bowel syndrome (IBS), ulcerative colitis and Crohn's disease, urogenital tract infection, inflammatory bowel disease (IBD) and colon cancer (Gardiner et al. (2002); Fooks et al. (2002); Mountzouris et al. (2002); Salminen et al. (2005)). Table 3.10 summarizes the effects of probiotics on humans (Gibson et al., 1996).

Prebiotics offer an alternative strategy to selectively stimulate the proliferation and activity of the gastrointestinal microbiota, while the probiotic approach aims to deliver supplemental beneficial live bacteria to the gut. Prebiotics are selectively fermented ingredients that remain largely undigested during passage through the stomach and small intestine and stimulate only beneficial population of bacteria in the human colon. To date, most prebiotics are non-digestible carbohydrates, particularly oligosaccharides such as lactulose, galacto-oligosaccharides (GOS), inulin, fructo-oligosaccharides and others (Macfarlane et al. (2006a, 2008)).

Table 3.10: Proposed effects of probiotics in human

<b>Proposed benefits of probiotics in human health</b>
Antitumour properties
Reduction of cholesterol
Improved lactose digestion
Relief from constipation
Stimulation of immune function through non-pathogenic means
Improved resistance to gastrointestinal infections
Treatment of traveller's diarrhoea
Reduction of antibiotic associated effects
Vitamin production
Induction of digestive enzymes

The health benefits of prebiotic in the gut include positive effect of the composition of the colonic microbiota, protection against enteric infections, improvement of mineral absorption, mimic cellular binding sites for pathogens, immunomodulation, suppressing production of proinflammatory cytokines, trophic and anti-neoplastic effects of SCFA, faecal bulking, and reduced toxigenic microbial metabolism (Kanauchi et al. (2008); Bouhnik et al. (2004); Gibson et al. (2004); Abrahms et al. (2005); Shoaf et al. (2006); Cummings et al. (2000, 2002); Pierre et al. (1997); Sands (2004)).

Some colonic bacteria can use prebiotic directly, and some other colonic bacteria can use prebiotic indirectly through cross-feeding, i.e. utilizing the metabolic products



from prebiotic (Ohtsuka et al. (1989); Belenguer et al. (2006)). There is little doubt from the human and animal studies that prebiotics can have microbiological effects on the dynamics of the colonic microbiota including increasing numbers of bifidobacteria and lactobacilli in the human colon (Bouhnik et al. (2004); Bartosch et al. (2005); Roberfroid, (2005)). The International Scientific Association for Probiotics and Prebiotics (ISAPP) and the International Probiotic Association (IPA, including over 150 probiotic manufacturers and distributors of probiotics) are two groups to work on probiotics and prebiotics (Vyas et al., 2012).

Synbiotics are combinations of probiotics and prebiotics which can be defined as ‘a mixture of pro- and pre-biotics which beneficially affects the host by improving survival and implantation of live microbial dietary supplements in the gastrointestinal tract (Gibson et al., 1995b). Health effects of synbiotics such as bifidobacteria and lactobacilli with dietary fiber (e.g. FOS and GOS) have been observed and synbiotic products may be a method of improving the stabilization of the probiotic activity (Schrezenmeir et al. (2001); Barrangou et al. (2006); Goh et al. (2006); Saulnier et al. (2008)).

# Chapter 4 Growth of *Lactobacilli* and *Bifidobacteria* in an *In Vitro* Batch Fermentation Model

## Abstract

The aim of the work presented in this Chapter was to extend our knowledge of the physiological behavior of lactobacilli, bifidobacteria and their mixture, and to determine kinetic parameters during their growth in an *in vitro* batch fermentation model. The experiments were carried out in a nutritionally complex gut medium with glucose as the sole carbohydrate source, to gain a better understanding of the growth behaviors of different probiotic strains. For comparison, the batch cultures were also conducted using MRS (de Man Rogosa and Sharp) broth. These experimental data will also be used in later chapters for validation of the mathematical models.

## 4.1 Introduction

The important roles played by the commensal intestinal microbiota include contributing to host nutrition, scavenging energy, shaping the development of the immune system, providing a natural defence mechanism against invading pathogenic bacteria and protecting against allergy development (Wilson (1995); Falk et al. (1998); Cebra (1999)). The colonization of the neonatal gut starts immediately after birth. The major components of the neonatal gut include enterobacteria, streptococci, bifidobacteria, lactobacilli, bacterioides and clostridia detected in the infants' faeces which are initially strongly influenced by the mode of birth, and subsequently by the diet, genetic background and environment of the individual. Lactobacilli and bifidobacteria are the predominant bacteria in the faeces of breast-fed babies which are thought to impart protection against infection (Mackie et al. (1999); Harmsen et al. (2000); Seale et al. (2013); Fernandez et al. (2013)). In general, the complex range of micro-organisms is thought to be stabilized after two years of age in the gut (Hentges 1993). These bacteria could be traditionally classified into groups such as eubacteria, clostridia, bacteroides, bifidobacteria and lactobacilli. Bifidobacteria make up approximately 5% of the large intestinal bacteria and lactobacilli are present as less than 1% of the bacteria, but they are very important in terms of their probiotic effect (Cummings 2009).

Research has been expanding rapidly to provide evidence for roles of the gut microbiota in human health and disease, several chronic diseases such as gastrointestinal tract infections, irritable bowel syndrome (IBS), inflammatory bowel disease (IBD), antibiotic-induced diarrhoea, colon cancers, cardiovascular disease and obesity have been found to relate to the perturbation of the intestinal microbiota. The administration of probiotics has led to a beneficial way to manipulate the gut microbiota in the hope of achieving health benefits in the host (McNaught et al. (2001); Saad et al. (2013)).

Probiotics are defined as 'live microorganisms that when administered in adequate amounts confer a health benefit on the host' (FAO/WHO, 2002). However, 'adequate amounts' of probiotic has not been quantitatively defined in this statement. It is believed that the number of microorganism which has a metabolic activity in the human intestine must be over  $10^6$  per gram of food at the time of consumption (Gilliland, 1989). The main health benefits of regular consumption of probiotic include the improvement of the intestinal microbial balance (Alhaj et al., 2007); managing lactose intolerance through the production of lactase (Sanders 2000); improving the immune function and prevent infections (Reid et al., 2003a); reducing the risk of colon cancer (Saikali et al., 2004); reducing some forms of food allergies (Alhaj et al., 2007); lowering the blood cholesterol levels (Ataie-Jafari et al., 2009); lowering suppression of blood pressure of hypertensive individuals (Sanders 2000); playing a key role in the prevention of diarrhoea (Van Niel et al. (2002); Allen et al. (2004)); reducing antibiotic-associate diarrhoea (Hickson et al., 2007); reducing inflammation (Kirjavainen et al., 2003) and inhibiting the growth of some pathogenic bacteria (Alhaj et al., 2007).

The main mechanisms of the action of probiotics include the production of antimicrobial substances to inhibit the pathogen replication (e.g. hydrogen peroxide, short chain fatty acid, diacetyl, bacteriocins and deconjugated bile acids) (Ouweland et al. (1999); Maqueda et al. (2008)); blocking adhesion of pathogens and toxins to epithelial cells (Lee et al. (2002); Gill (2003); Mack et al. (2003)); blocking invasiveness of pathogens to epithelial cells (Hess et al., 2004); modulation of non-specific and specific host immune response in diseased and healthy subjects (e.g. stimulating production of secretory IgA and mucus and attenuating pro-inflammatory responses) (Malin et al. (1996); Mack et al. (1999); Neish et al. (2000); Wold, (2001)). The effect of probiotic intake on the human health and disease can be assessed through *in vivo* and *in vitro* models.

Probiotics consist mostly of *Lactobacillus* spp. and *Bifidobacterium* spp., but strains of *Enterococcus* spp., *Bacillus* spp. and some yeast such as *Saccharomyces*

---

*boulardii* have also been found as suitable candidates. Lactobacilli and bifidobacteria are both gram-positive bacteria that differ in the G+C content. The growth of *lactobacilli* is optimum at pH 5.5-5.8 and temperature 35-45°C, while the growth of *bifidobacteria* is optimum at pH 6.5-7.0 and temperature 20-46°C (Arunachalam, 1999). There is only a small number of *Lactobacillus* species that are indigenous inhabitants in the GI tract, and most of them are allochthonous members. Bifidobacteria is the third most common bacteria population in the human gut after bacteroides and eubacteria (Charteris et al., 1997). Some of the beneficial effects of lactobacilli are (i) stimulating the vitamin synthesis and enzyme production; (ii) competing with pathogens for nutrition and space; (iii) antimicrobial substances production; (iv) reducing the serum cholesterol and (v) detoxification of carcinogens produced by colon cancer patients (Naidu et al., 1999). Some of the beneficial effects of bifidobacteria are (i) suppressing harmful bacteria by producing SCFA to control the pH of the large intestine (Gibson et al., 1995b); (ii) stimulating vitamin B production (Gibson et al., 1995b) (iii) promoting immunological response against malignant cells (Reddy et al., 1993); (iv) reducing serum cholesterol (Pereira et al., 2002) and (v) managing lactose intolerance (Fooks et al., 1999)). Due to their phylogenetic relations, metabolic properties, and incorporation in the functional food and daily supplement industry, lactobacilli are aligned with bifidobacteria as probiotic LAB & B (lactic acid bacteria and bifidobacteria) which provide many beneficial effects to the host via the human GI tract (Vaughan et al. (2002); Reid et al. (2003b)).

The global market of probiotic ingredients, supplements and food was worth \$14.9 billion in 2007 and 15.9 billion in 2008, and was expected to reach 19.6 billion in 2013 (Agheyisi 2008). Some probiotic products in the market are listed in Table 4.1. However, health benefits obtained from probiotic bacteria are strain specific, not species- or genus-specific. There does not seem to be one probiotic strain that can provide all proposed benefits. National and international authorities have the obligation to ensure that consumers could be able to choose the probiotic food correctly rather than just look at the product which may not contain adequate

amounts of probiotic strains. Research on specific probiotic products and their health benefits is required to ensure the effectiveness of this particular product.

Table 4.1: Commercial probiotic microorganisms

Strain	Commercial products	Source
<i>L. acidophilus</i> NCFM / <i>B. lactis</i> Bi-07 / <i>B. lactis</i> HN019 (DR10) / <i>L. rhamnosus</i> HN001 (DR20)	Sold as ingredient	Danisco (Madison WI)
<i>L. fermentum</i> VRI003 (PCC)	Sold as ingredient	Probiomix (Eveleigh, Australia)
<i>Saccharomyces cerevisiae</i> <i>boulardii</i>	Florastor	Biocodex (Creswell OR)
<i>L. rhamnosus</i> R0011 / <i>L. acidophilus</i> R0052	Sold as ingredient	Institut Rosell lallemand (Montreal, Canada)
<i>B. lactis</i> Bb-12 / <i>L. acidophilus</i> LA5 / <i>L. paracasei</i> CRL 431 / <i>L. paracasei</i> F-19 / <i>L. fermentum</i> VRI003 (PCC)	Sold as ingredient	Chr. Hansen (Milwaukee WI)
<i>B. lactis</i> Bb-12	Good Start Natural Culture infant formula	Nestle (Glendale, CA) Chr. Hansen (Milwaukee WI)
<i>L. casei</i> Shirota / <i>B. breve</i> strain Yakult	Yakult	Yakult (Tokyo, Japan)
<i>L. casei</i> DN-114 001 (' <i>L. casei</i> Immunitas') / <i>B. animalis</i> DN173 010 (' <i>Bifidus regularis</i> ')	DanActive fermented milk Activia yogurt	DAnone (Paris, France) Dannon (Tarrytown, NY)
<i>L. reuteri</i> RC-14 / <i>L. rhamnosus</i> GR-1	Femdophilus	Chr. Hansens (Milwaukee WI) Urex Biotech (London, Ontario, Canada) Jarrow Formulas (Los Angeles, CA)
<i>L. johnsonii</i> Lj-1 (same as NCC533 and formerly <i>L. acidophilus</i> La-1)		Nestle (Lausanne, Switzerland)
<i>L. plantarum</i> 299V / <i>L. rhamnosus</i> 271	Sold as ingredient Good Belly juice product	Probi AB (Lund, Sweden); NextFoods (Boulder, Colorado)

<i>L. reuteri</i> ATCC 55730 (‘Protectis’)	BioGaia Probiotic chewable tablets or drops	Biogaia (Stockholm, Sweden)
<i>L. rhamnosus</i> LB21 / <i>Lactococcus lactis</i> L1A	Sold as ingredient	Essum AB (Umea, Sweden)
<i>L. rhamnosus</i> GG (‘LGG’)	Culturelle	Valio Dairy (Helsinki, Finland) Dannon (Tarrytown, NY)
<i>L. salivarius</i> UCC118		University College (Cork, Ireland)
<i>B. longum</i> BB536	Sold as ingredient	Morinaga Milk Industry Co., Ltd. (Zama-City, Japan)
<i>L. acidophilus</i> LB	Sold as ingredient	Lacteol Laboratory (Houdan, France)
<i>L. paracasei</i> F19	Sold as ingredient	Medipharm (Des Moines, Iowa)
<i>L. paracasei</i> 33 / <i>L. rhamnosus</i> GM-020 / <i>L. paracasei</i> GMNL-33	Sold as ingredient	GenMont Biotech (Taiwan)

Source: <http://cdrf.org/home/checkoff-investments/usprobiotics> (Anonymous, 2011)

Commercial probiotic products must fulfill a number of criteria such as safety and stability (activity and viability in products); resistance to gastric acid, bile salts and pancreatic enzymes; adherence to colonic mucosa and ability to colonize *in vivo*; and functional and physiological aspects (invasive potential, antimicrobial activity, against pathogens and clinical side effects in volunteers/patients) (Gorbach et al. (2002); Vasiljevie et al. (2008); Soccol et al. (2010)). To ensure probiotic stability and improve the high cell yield at large scale, more efficient processing technologies of probiotics have been developed rapidly in recent years such as membrane systems with continuous fermentation, appropriate selection of acid and bile resistant strains, incorporation of micronutrients such as peptides; use of oxygen impermeable reactor, cell immobilization and microencapsulation technology to get the high cell yield (Lacroix et al. (2007); Soccol et al. (2010)). With these developed technologies plus the exciting scientific and clinical findings of various probiotic organisms, probiotics have become an important functional food ingredients, expanding to the pharmaceutical and supplement industries.

Probiotic products on the daily supplement market are presented in the forms of powders, tablets, liquid suspensions and sprays, and are intended to be used by humans, farm animals and pets. Most preparations destined for human consumption are powders or tablets. Cultech Ltd. and Obsidian Research Ltd. (part of the sponsor of this project) is a UK based nutraceutical company which developed a range of high quality, viable, stable probiotic products in various packaged formats. LAB4<sup>®</sup> probiotic is the name given to the probiotic bacteria strains developed by Cultech Ltd. Cultech is the only company holding a license to supply probiotics as Investigative Medicinal Products (IMPs) for use in clinical trials. LAB4 is for adults and LAB4B is for pregnancy, and infants from birth to four years. Both types have substantial independent evidence to support their benefits, such as reduced total symptoms and improved quality of life in diagnosed IBS sufferers, prevention of atopic sensitization and atopic eczema and reduced overgrowth of undesirable and potential harmful bacteria after antibiotic therapy (Plummer et al. (2004, 2005); Madden et al. (2005); Williams et al. (2009); Allen et al. (2010)).

LAB4 consists of four specially selected probiotic bacteria: *Lactobacillus acidophilus* – strain 1, *Bifidobacterium bifidum*, *Lactobacillus acidophilus* – strain 2 and *bifidobacterium animalis subsp lactis*. LAB4B consists of *Lactobacillus salivarius*, *Lactobacillus paracasei*, *Bifidobacterium animalis subsp lactis* and *Bifidobacterium bifidum*. All the above probiotic strains profiles have been established in Cultech including taxonomy and identity, acid tolerance, bile salt tolerance, bile salt hydrolase activity, pepsin and pancreatic resistance, adherence to human intestinal cells (Caco-2 cells), antimicrobial activity against pathogens, antibiotic susceptibility and haemolytic activity. All these items fulfill the above mentioned criteria for commercial probiotic products.

Since the recognition of the beneficial effects of lactobacilli and bifidobacteria, there has been considerable research dealing with carbohydrate fermentation by these two groups of organisms. Some carbohydrates are capable of promoting the selective growth of lactobacilli and bifidobacteria in the colon. Such compounds have been

---



called prebiotics. By combining probiotic and prebiotic into the so-called synbiotic products, a twofold positive effect on the intestine microflora can be expected (Gibson et al. (1995b); Ziemer et al. (1998)). Several types of *in vitro* fermentation systems have been employed to investigate the growth behavior and fermentative capabilities of these two organisms (Shene et al. (2005); Perrin et al. (2001); Rossi et al. (2005); Gibson et al. (1994a); Hopkins et al. (1998)). Using *in vitro* fermentation systems, they can be categorized with respect to the number of bacterial strains cultivated (pure or mixed culture), the carbohydrate sources for bacterial growth and the operation model (batch, semi-continuous or continuous).

So far, no quantitative comparison of the physiological behavior of LAB4 and LAB4B in the human gut has been done. The purpose of the present work was to extend the knowledge of the physiology of lactobacilli and bifidobacteria, and to determine the kinetic parameters during growth in an *in vitro* fermentation system that simulates the human gut environment. These parameters will be important in the design and operation of the production processes of probiotic. The initial experiments in this Chapter were carried out in a nutritionally complex gut medium with glucose as the sole carbohydrate source in an *in vitro* batch fermentation model. The individual probiotic strains (*Lactobacillus salivarius*, *Lactobacillus paracasei*, *Lactobacillus acidophilus*, *Bifidobacterium bifidum* and *Bifidobacterium animalis subsp lactis* from Cultech Ltd. UK) and their co-cultures were fermented in either a simple non-stirred batch culture without pH control or a stirred batch culture with pH control. The studies were also performed in batch cultures using MRS (de Man Rogosa and Sharp) broth as a comparison. An anaerobic workstation was purposely designed, built and used to simulate the anaerobic environment in the human colon. A mathematical model for the growth of different probiotic strains in batch cultures was developed, which will be explained in the later chapters. The kinetic growth data were fed into this model in order to provide the comparison results of the different probiotic strains in the simulated environment of the human colon. Here, we choose glucose as the sole carbohydrate source because it is the simplest sugar that can be used by any bacteria. A major consideration is to reduce the complexity of the gut

---

medium so that the experimental data can be more readily fed into the simplified mathematical model based on glucose utilization of different probiotic strains.

## 4.2 Materials and methods

### 4.2.1 Commercially available probiotic strains

Table 4.2: Freeze-dried powders of six probiotic strains stock

Cultech/Obsidian Reference No.	Organism	Broth medium	Agar medium
CUL08	<i>Lactobacillus paracasei</i>	MRS <sup>1</sup>	MRS <sup>2</sup>
CUL61	<i>Lactobacillus salivarius</i>	MRS	MRS
CUL60	<i>Lactobacillus acidophilus</i>	MRS	MRS
CUL21	<i>Lactobacillus acidophilus</i>	MRS	MRS
CUL20	<i>Bifidobacterium bifidum</i>	MRSX <sup>3</sup>	MRSX <sup>4</sup>
CUL34	<i>Bifidobacterium animalis subsp lactis</i>	MRSX	MRSX
LAB4	<i>Lactobacillus acidophilus</i> –CUL60; <i>Lactobacillus acidophilus</i> –CUL21; <i>Bifidobacterium bifidum</i> –CUL20; <i>Bifidobacterium animalis subsp lactis</i> –CUL34	MRS & MRSX	MRS & MRSX
LAB4B	<i>Lactobacillus paracasei</i> –CUL08; <i>Lactobacillus salivarius</i> –CUL61; <i>Bifidobacterium bifidum</i> –CUL20; <i>Bifidobacterium animalis subsp lactis</i> –CUL34	MRS & MRSX	MRS & MRS-MUP <sup>5</sup>

<sup>1</sup>MRS broth: de Man Rogosa and Sharp (CM0359, Oxoid, UK);

<sup>2</sup>MRS agar: de Man Rogosa and Sharp (CM0361, Oxoid UK);

<sup>3</sup>MRSX broth: Modified MRS broth containing 0.2% Lithium Chloride (L0505, Sigma-Aldrich, UK), 0.3% Propionic Acid (P1880, Sigma-Aldrich, UK) and 0.05% L-cysteine Hydrochloride (C/9152/48, Fischer, UK);

<sup>4</sup>MRSX agar: Modified MRS agar containing 5% Defibrinated Sheep Blood (TCS SB054, Cruinn Diagnostics Ltd., Ireland), 0.2% Lithium Chloride, 0.3% Propionic Acid and 0.05% L-cysteine Hydrochloride;

<sup>5</sup>MRS-MUP agar: Modified MRS Agar containing 5% Defibrinated Sheep Blood, 0.3% Propionic Acid, 0.05% L-cysteine Hydrochloride and 50ug/ml Lithium-mupirocin supplement (69732, Sigma-Aldrich, UK).

Six probiotic strains were selected for investigation of the growth behavior in gut medium, and they include *Lactobacillus salivarius* CUL61 NCIMB 30211, *Lactobacillus paracasei* CUL08 NCIMB 30154, *Lactobacillus acidophilus* CUL60 NCIMB 30157 *Lactobacillus acidophilus*, *Lactobacillus acidophilus* CUL21 NCIMB 30156, *Bifidobacterium bifidum* CUL20 NCIMB 30153 and *Bifidobacterium animalis subsp lactis* CUL34 NCIMB 30172. These were screened due to their extensive use as a terrestrial probiotic supplement in numerous commercial products from Cultech/Obsidian Ltd. (this project's industrial sponsor). Choosing these six probiotic strains also makes it convenient to access large quantities of homogeneous bacterium for experiments. As listed in Table 4.2, freeze-dried powders of six individual strains and their mixture were used in this study. These strains are all approved by the probiotic strains profile identification in Cultech/Obsidian Ltd. The organisms from freeze-dried powder is recovered by taking a spoon of powder into 4.5 ml sterile Maximal Recovery Diluent (MRD) ((CM0733, Oxoid, UK)), streaking 20 $\mu$ l aliquots onto the appropriate solid medium (see Table 4.2), and incubating the agar plates anaerobically at 37°C for 72 hours.

#### 4.2.2 Chemicals and media

The culture medium used in this study is Modified Macfarlane's Gut Medium (MMGM) (Macfarlane et al. 1998) which replaces the polysaccharides simply with glucose as the solo carbon source. It consisted of the following constituents (g/liter) in distilled water: glucose (Sigma-Aldrich, UK) 15.0; casein (BDH Ltd., UK) 3.0; peptone water (Oxoid, UK) 5.0; tryptone (Oxoid, UK) 5.0; bile salts No.3 (Sigma-Aldrich, UK) 0.4; yeast extract (Oxoid, UK) 4.5; FeSO<sub>4</sub> • 7H<sub>2</sub>O (BDH Ltd., UK) 0.005; NaCl (BDH Ltd., UK) 4.5; KCl (BDH Ltd., UK) 4.5; KH<sub>2</sub>PO<sub>4</sub> (BDH Ltd., UK) 0.5 ; MgSO<sub>4</sub> • 7H<sub>2</sub>O (BDH Ltd., UK) 1.25; CaCl<sub>2</sub> • 6H<sub>2</sub>O (BDH Ltd., UK) 0.15; NaHCO<sub>3</sub> (BDH Ltd., UK) 1.5; cysteine (Sigma-Aldrich, UK) 0.8; hemin (BDH Ltd., UK) 0.05; Tween 80 (Sigma-Aldrich, UK) 1.0.

MRS broth (Oxoid, UK) was also used in this study as a control medium to compare the growth behavior of different probiotic and co-cultures in various initial conditions.

#### 4.2.3 Batch cultivation conditions

Batch culture incubations were carried out in a 500ml glass vessel with a 250ml working volume. The medium was first autoclaved at 121°C for 15 min. After cooling down, the fermentor was inoculated (1%, v/v) with an exponential phase pre-culture of individual probiotic strains. Growth was monitored by collecting samples from the cultures at appropriate intervals. The medium pH was either non-regulated or regulated to 5.5 or 6.5 by the automatic addition of 1 mol/l NaOH which was chosen to simulate the pH of the ascending colon (pH 5.5-5.9) and descending colon (pH 6.5-6.9). The fermentor was maintained in a specially designed anaerobic workstation, with temperature controlled at 37°C. An autoclavable pH electrode (51343111 pH ELECTRODE INLAB POWDER PRO, VWR International Ltd, UK) was connected to a pH controller (RZ-56022-87 DLX pH-RX/MBB SERIES METERING PUMP, Cole-Parmer, USA) via a cable (662-1240 Cable ISM-Multi Pin 1.8m, VWR International Ltd, UK), to provide continuous monitoring as well as servo-controlled addition of 1N NaOH to maintain the pH at the set value of 5.5 or 6.5. During the whole period of batch culturing, the vessel was continuously stirred by using the mini stirrer (FB70800 E-STEM Standard MiniStirrer, Fisher Scientific, UK).

#### 4.2.4 Growth of individual *Lactobacilli* strain under different culture conditions

Using MRS agar, a streak plate of *Lactobacillus salivarius* CUL61 organism or other organism (*L.paracasei* CUL08, *L.acidophilus* CUL60 or *L.acidophilus* CUL21) was directly generated from 10<sup>-1</sup> dilution (0.5 g into 4.5 ml of sterile MRD) of freeze dried powder (See 4.2.1). Then, a single well-isolated colony of the pure CUL61 organism from streak MRS agar plate was inoculated into 10 ml MRS broth medium, after which it was placed in the anaerobic workstation at 37°C for overnight to get

---

the exponential phase pre-culture. Next, 2.5 ml of CUL61 pre-culture was inoculated into 250 ml sterilised MRS broth and MMGM (modified Macfarlane's gut medium) at initial pH 6.5 and 5.5 respectively. The testing was carried out by taking 5 ml of samples from the cultures at fixed intervals (0, 2, 4, 6, 8, 10, 12, 14, 16, 18, 20, 22, 24, 26, 28, 30, 48 hours). Another separate testing was conducted under controlled pH condition. For this, 2.5 ml of CUL61 pre-culture was inoculated into 250 ml sterilised MMGM at controlled pH 6.5 and 5.5 respectively. The pH was controlled by dosing with 1mol/l sterilised NaOH. The testing was similarly conducted by taking 5 ml of samples from the cultures at fixed intervals (0, 4, 6, 8, 10, 24, 26, 28, 30, 32, 48 hours). Finally, for all testing samples, the growth profile and pH profile of individual lactobacilli strain under different culture conditions were measured. The detailed measurement procedures are explained in Sections 4.2.5 and 4.2.6.

#### 4.2.5 Enumeration of lactobacilli and bifidobacteria

##### 4.2.5.1 Anaerobic condition

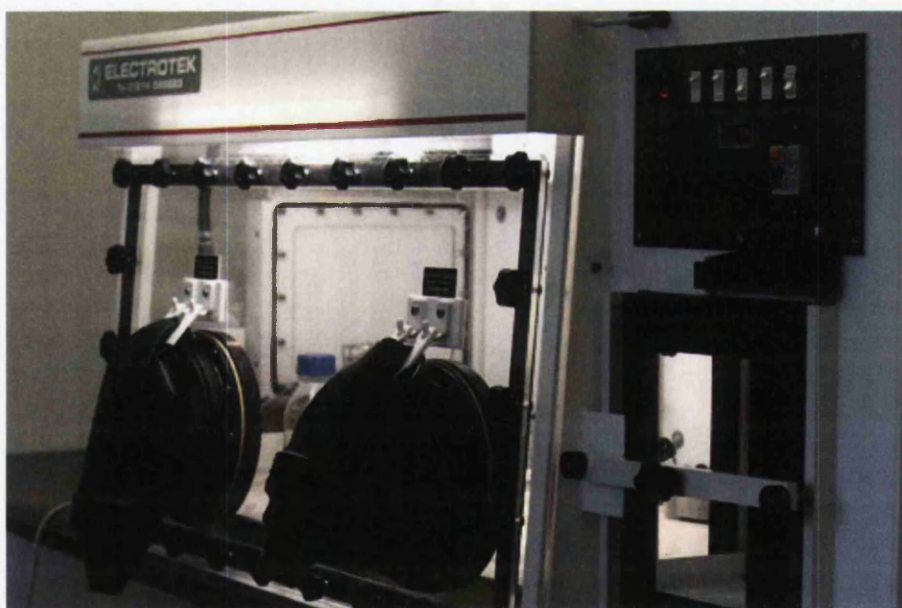

Figure 4.1: Anaerobic workstation (The design is specified by Lei Jiang and the manufacturer is Electrotek Ltd., Yorkshire, UK)

All the inoculation and sample collection were operated in an anaerobic workstation (Figure 4.1). The design of the anaerobic workstation was specified by Lei Jiang during this research work and it was manufactured by Electrotek Ltd., Yorkshire, UK. The workstation was supplied with an anaerobic growth mixture gas (BOC Special Gases, Manchester, UK) containing a gas mixture of 10% CO<sub>2</sub>, 10% H<sub>2</sub> and 80% N<sub>2</sub>. Air in the workstation was checked for oxygenation on a daily basis using an anaerobic indicator solution containing a saturated solution of sodium bicarbonate, glucose anhydrous and a 1% methylene blue solution (Electrotek Ltd., Yorkshire, UK). Air from the workstation was bubbled through a tube into the solution. A colour change from pale brown to blue indicates the presence of oxygen. The cabinet temperature was maintained at 37°C and humidity was maintained at 70%.

#### **4.2.5.2 Enumeration of lactobacilli and bifidobacteria**

A sample of 5ml of batch culture was taken from the fermentor in the anaerobic workstation and added into a 30 ml plastic sterile universal. The universal was transferred outside the workstation and placed in an operator safety cabinet (Envair Bio+2, Lancashire, UK) with a filtered air flow. A volume of 0.5 ml batch culture was added to the bijou containing 4.5 ml pre-reduced Maximum Recovery Diluent (MRD) (Oxoid, UK) to form a 10<sup>-1</sup> dilution. Then, a volume of 0.5 ml of the 10<sup>-1</sup> dilution was added to 4.5 ml MRD to produce the 10<sup>-2</sup> dilution. A decimal dilution series was prepared to 10<sup>-8</sup> following these steps.

A modified version of the Miles and Misra Technique (1938) was used to enumerate viable microorganisms. Ten 10 µl drops of the -5 to -8 dilution were pipetted onto MRS, MRSX and MRS-MUP agar plates (see Table 4.2) using an eLINE electronic pipette (Biohit, Finland). Plates were allowed dry, inverted, and incubated in an anaerobic workstation at 37°C for 3 days.

#### 4.2.6 pH analysis

After enumeration of lactobacilli and bifidobacteria, the pH values of batch culture samples in the 30 ml plastic sterile universal were tested using a pH controller (RZ-56022-87 DLX pH-RX/MBB SERIES METERING PUMP, Cole-Parmer, USA) with a pH electrode (RZ-27013-22 ELECTRODE PH 25 FT CABLE, Cole-Parmer, USA).

#### 4.2.7 Estimation of growth curves

Growth parameters, estimated by using a modified six-parameter Gompertz model, are:  $\log_{10} (\text{cfu ml}^{-1})_t$  (cell concentration at time  $t$ );  $\log_{10} (\text{cfu ml}^{-1})_0$  (cell concentration at time 0);  $A$  (increase of biomass between  $\log_{10} (\text{cfu ml}^{-1})_0$  and  $\log_{10} (\text{cfu ml}^{-1})_{\text{max}}$ );  $\mu$  (maximum specific growth rate ( $\text{h}^{-1}$ ));  $t_d$  (biomass doubling time (h)); and  $\lambda$  (duration time of lag phase (h)) (Zwietering et al. (1990); Juarez Tomas et al. (2002)).

#### 4.2.8 Growth of LAB4B and LAB4

The compositions of LAB4B and LAB4 can be found in Table 4.2. The overnight broth of 6 probiotic strains (*L.salivarius* CUL61, *L.paracasei* CUL08, *L.acidophilus* CUL60, *L.acidophilus* CUL21, *B.lactis* CUL34 and *B. bifidum* CUL20) were prepared following the procedure described in Section 4.2.4 (for the preparation of CUL34 and CUL20 overnight broth, MRSX broth and agar were used instead of MRS broth and agar). Then, 2.5 ml broth of CUL61, CUL08, CUL34 and CUL20 as LAB4B was inoculated into two sterilized 250 ml MMGM broth at pH 6.5 and 5.5 respectively. At the same time, 2.5 ml broth of CUL60, CUL21, CUL34 and CUL20 as LAB4 was inoculated into two sterilized 250 ml MMGM broth at pH 6.5 and 5.5 respectively. For testing, 5 ml of samples were withdrawn from the cultures at appropriate intervals (0, 4, 6, 8, 24, 28, 32 and 48 hours).

## 4.3 Results

### 4.3.1 Growth of *Lactobacillus salivarius* CUL61

Growth profile and pH profile of *L.salivarius* CUL61 under different culture conditions were determined (See Sections 4.2.5 and 4.2.6) and the maximum specific growth rate  $\mu$  was calculated from the slopes of the growth curve in the log coordinates (See Section 4.2.7). Doubling time was determined by the maximum specific growth rate (See Section 4.2.7). Figure 4.2 and Figure 4.3 show the growth curve and pH trend of *L.salivarius* CUL61 in combinations of two culture media (MRS broth or MMGM), two uncontrolled pH values (6.5 or 5.5) and two controlled pH values (6.5 or 5.5). The temperature of all these batch cultures was set at 37°C.

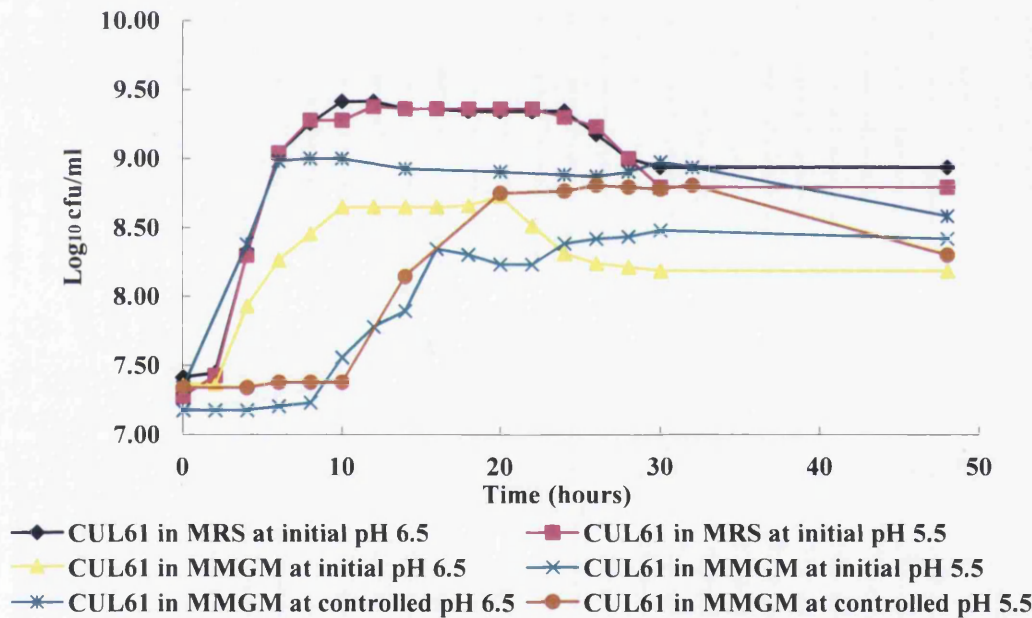

Figure 4.2: Growth of *L.salivarius* CUL61 under different culture conditions.



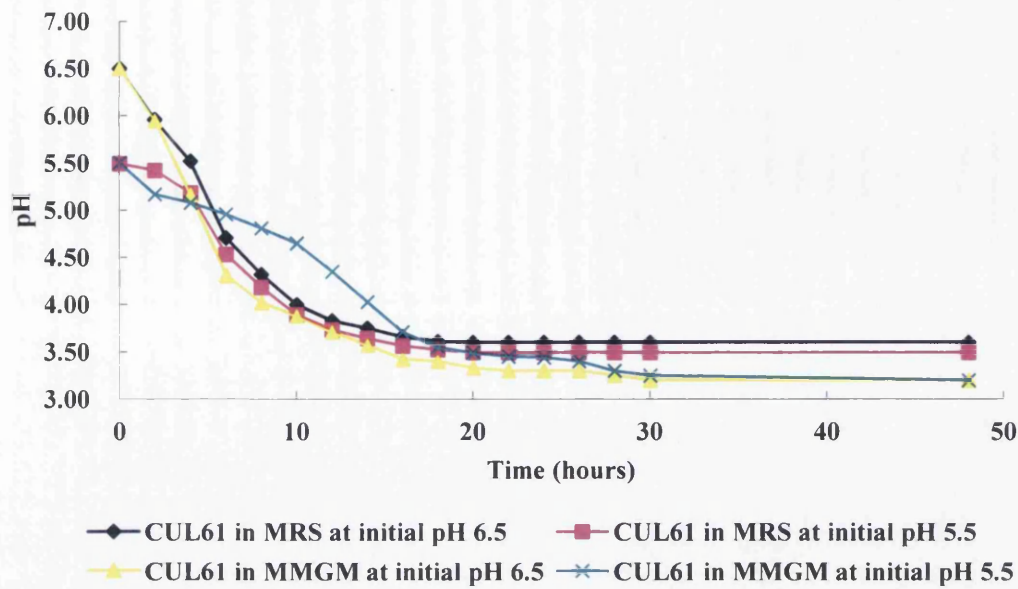

Figure 4.3: pH changes of *L.salivarius* CUL61 under different culture conditions.

Table 4.3: Estimation of growth parameters of *L.salivarius* CUL61 under different culture conditions

Conditions	$\log_{10}(\text{cfu ml}^{-1})_0$	$A$	$\mu (\text{h}^{-1})$	$t_d (\text{h})$	$\lambda (\text{h})$
MRS at initial pH 6.5	7.41	2.00	0.92	0.75	2.00
MRS at initial pH 5.5	7.28	2.10	0.92	0.75	2.00
MMGM at initial pH 6.5	7.36	1.36	0.35	2.01	2.00
MMGM at initial pH 5.5	7.18	1.30	0.30	2.32	8.00
MMGM at controlled pH 6.5	7.34	1.66	0.62	1.11	0.00
MMGM at controlled pH 5.5	7.34	1.45	0.30	2.32	10.00

Parameters:  $\log_{10}(\text{cfu ml}^{-1})_0$ , initial biomass;  $A$ , increase between initial and final biomass;  $\mu$ , maximum specific growth rate;  $t_d$ , biomass doubling time;  $\lambda$ , lag phase.

The results in Figure 4.2 show that the biomass productions and the specific growth rate are the same in MRS at initial pH 6.5 and 5.5. There is also the same pH drop pattern in MRS broth (Figure 4.3) which indicates that the MRS broth has a strong buffer capacity and it will not affect the growth pattern of CUL61 at different pH conditions. The biomass productions and the specific growth rate in MRS are higher than in MMGM with controlled and uncontrolled pH which is easily explained by the fact that MRS contains more nutrient than MMGM.

The results in Figure 4.2 also show that it took 6 hours longer to start the log phase (or exponential phase) in MMGM at initial pH 5.5 than the case with the initial pH 6.5. Results may indicate lower pH (5.5) can delay the log phase of CUL61 up to 6 hours. Figure 4.3 shows that the pH drops more slowly in MMGM at initial pH 5.5, and this is consistent with the fact that CUL61 got into the log phase a few hours later than the case of initial pH 6.5. However, the total biomass production was approximately the same in MMGM grown at initial pH 6.5 and 5.5 (1.36 and 1.3  $\log_{10}$  cfu ml<sup>-1</sup> respectively). The specific growth rates  $\mu$  were also similar at pH 6.5 and 5.5 (0.35 and 0.30 respectively). These indicate that, once the bacteria were acclimated to the environment conditions, the biomass production and the specific growth rate are essentially constant.

The results in Figure 4.2 also show that it took 10 hours longer to start the log phase (or exponential phase) in MMGM at controlled pH 5.5 than the case with a controlled pH 6.5. The results also prove the previous result that lower pH (5.5) would delay the log phase of CUL61 up to 10 hours. The increased biomass production in MMGM at controlled pH 6.5 is higher than at controlled pH 5.5 (1.66 and 1.45  $\log_{10}$  (cfu ml<sup>-1</sup>) respectively). After the lag phase, for these two cases, the specific growth rate in MMGM at controlled pH 6.5 was two times higher than it is at controlled pH 5.5 (0.62 and 0.30 respectively). This implies that the controlled pH 6.5 of the MMGM has significant effects on all growth parameters tested (increases of biomass, growth rate, reduces lag phase and the doubling time). It also indicates that controlling the pH condition is an effective way to achieve the maximum biomass production yield.

The highest maximum specific growth rate ( $\mu$ ) were obtained on MRS, followed by MMGM with controlled / uncontrolled pH 6.5, and MMGM with controlled / uncontrolled pH 5.5. The highest increased biomass production ( $\mathcal{A}$ ) was obtained on MRS, followed by MMGM with controlled pH, and MMGM with uncontrolled pH. The detailed figures are given in Table 4.3. MRS broth affected the final biomass and specific growth rate significantly because the high nutrition available compared with

---

MMGM. However, MRS is the only control medium used in this study, our target is to investigate the growth behaviour of different probiotic strains in MMGM. The experiment shows that optimal conditions for the growth of *L.salivarius* CUL61 were MMGM with controlled pH 6.5 at 37°C. Under these conditions, the highest biomass and specific growth rates, together with shorter lag phases and doubling time, were obtained.

#### 4.3.2 Growth of *Lactobacillus paracasei* CUL08

This experiment follows a similar procedure as described in Section 4.2.4. Figure 4.4 and Figure 4.5 show the growth curve and pH trend of *L.paracasei* CUL08 in combinations of two culture media (MRS broth or MMGM) , two uncontrolled pH values (6.5 or 5.5) and two controlled pH values (6.5 or 5.5) at 37°C.

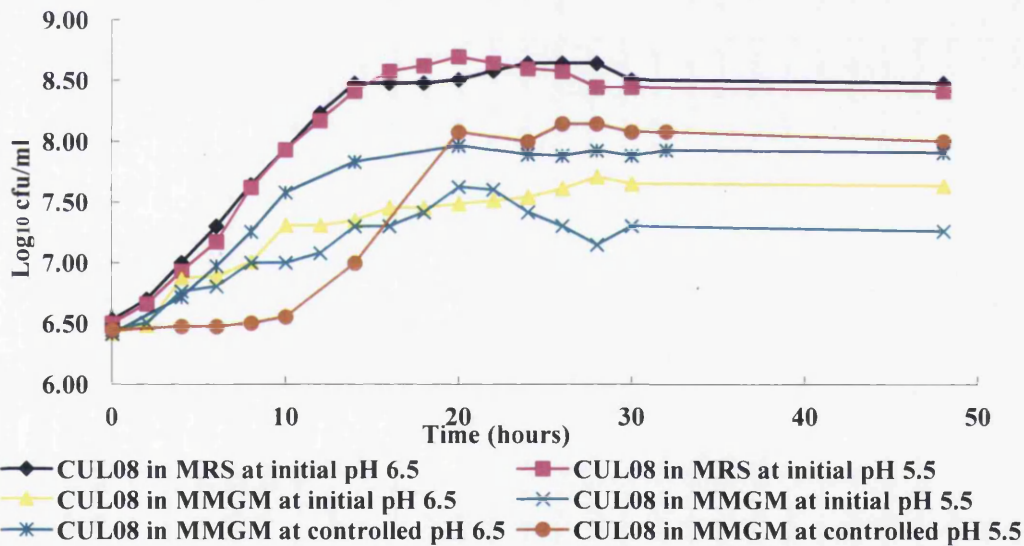

Figure 4.4: Growth of *L.paracasei* CUL08.

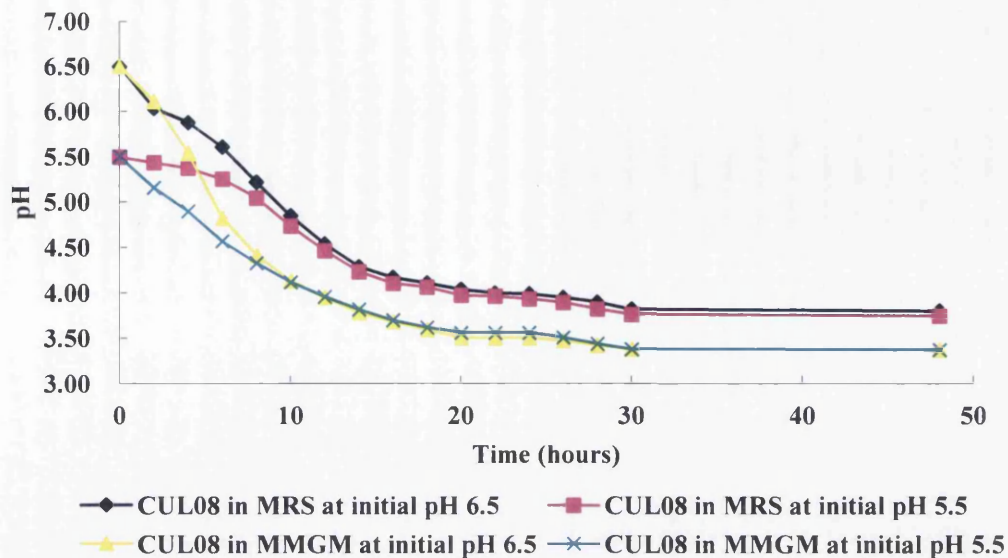

Figure 4.5: pH changes of *L.paracasei* CUL08.

The results in Figure 4.4 and Figure 4.5 show that the growth behavior and pH trend of *L.paracasei* CUL08 is similar to *L.salivarius* CUL61 under different culture conditions. However, the specific growth rates of CUL08 are all lower than CUL61 which result in the higher doubling time of CUL08.

Table 4.4: Estimation of growth parameters of *L.paracasei* CUL08

Conditions	$\log_{10}(\text{cfu ml}^{-1})_0$	$A$	$\mu$ ( $\text{h}^{-1}$ )	$t_d$ (h)	$\lambda$ (h)
MRS at initial pH 6.5	6.53	2.11	0.35	2.01	2.00
MRS at initial pH 5.5	6.51	2.19	0.35	2.01	2.00
MMGM at initial pH 6.5	6.41	1.29	0.21	3.34	2.00
MMGM at initial pH 5.5	6.45	1.17	0.14	5.02	4.00
MMGM at controlled pH 6.5	6.41	1.55	0.28	2.51	2.00
MMGM at controlled pH 5.5	6.45	1.70	0.35	2.01	10.00

Parameters:  $\log_{10}(\text{cfu ml}^{-1})_0$ , initial biomass;  $A$ , increase between initial and final biomass;  $\mu$ , maximum specific growth rate;  $t_d$ , biomass doubling time;  $\lambda$ , lag phase.

The maximum specific growth rate of CUL08 was similar on MRS and MMGM with controlled pH 6.5 and 5.5, while the lowest values were obtained from MMGM with uncontrolled pH 6.5 and 5.5 (Table 4.4). With uncontrolled pH setup, the pH drops

continuously during the log phase, and the acid environment may inhibit the cell division resulting in the lower specific growth rates.

The results in Figure 4.4 also show that it took 8 hours longer to start the log phase in MMGM at controlled pH 5.5 than at controlled pH 6.5. The same trend was obtained from CUL61, and this indicates that lower pH (5.5) will delay the log phase. After the bacteria were acclimated to the environment conditions, the biomass production and the specific growth rate were essentially constant.

#### 4.3.3 Growth of *Lactobacillus acidophilus* CUL60 or *Lactobacillus acidophilus* CUL21

This experiment follows a similar procedure as described in Section 4.2.4. Figure 4.6, Figure 4.7, Figure 4.8 and Figure 4.9 show the growth curves and pH trends of *L. acidophilus* CUL60 and CUL21 in combinations of two culture media (MRS broth or MMGM), two uncontrolled pH values (6.5 or 5.5) and two controlled pH values (6.5 or 5.5) at 37°C.

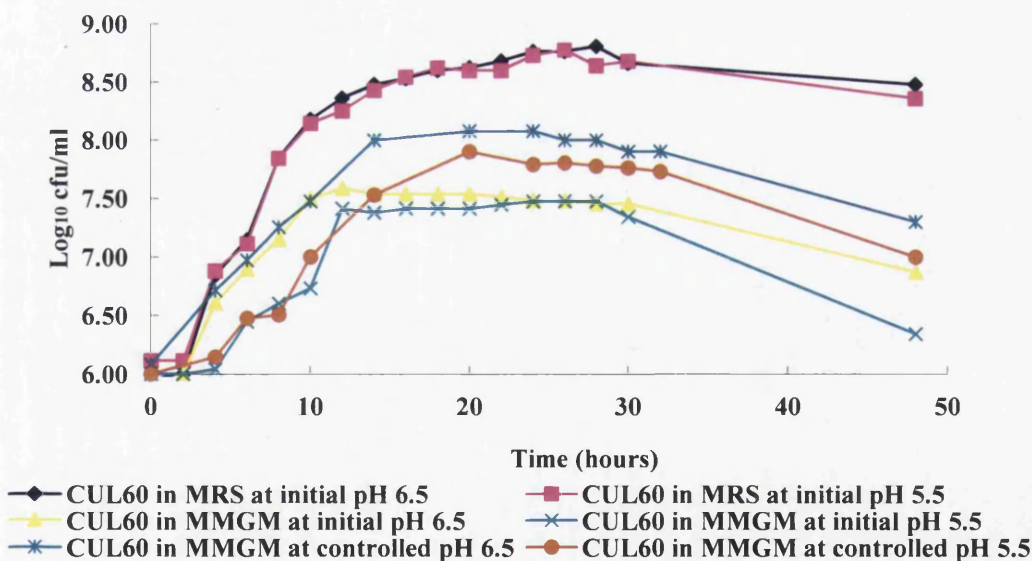

Figure 4.6: Growth of *L. acidophilus* CUL60.

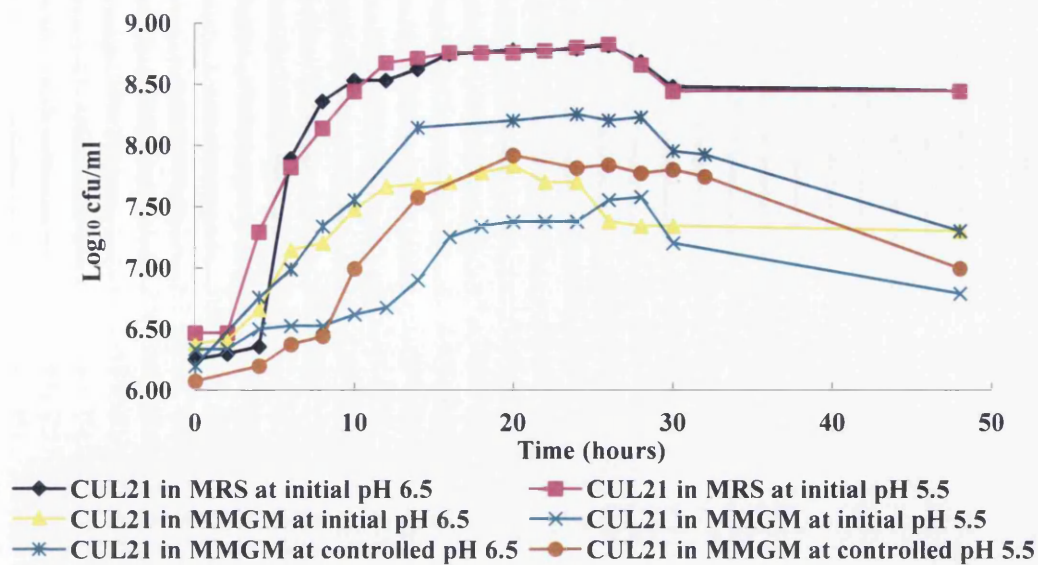

Figure 4.7: Growth of *L.acidophilus* CUL21.

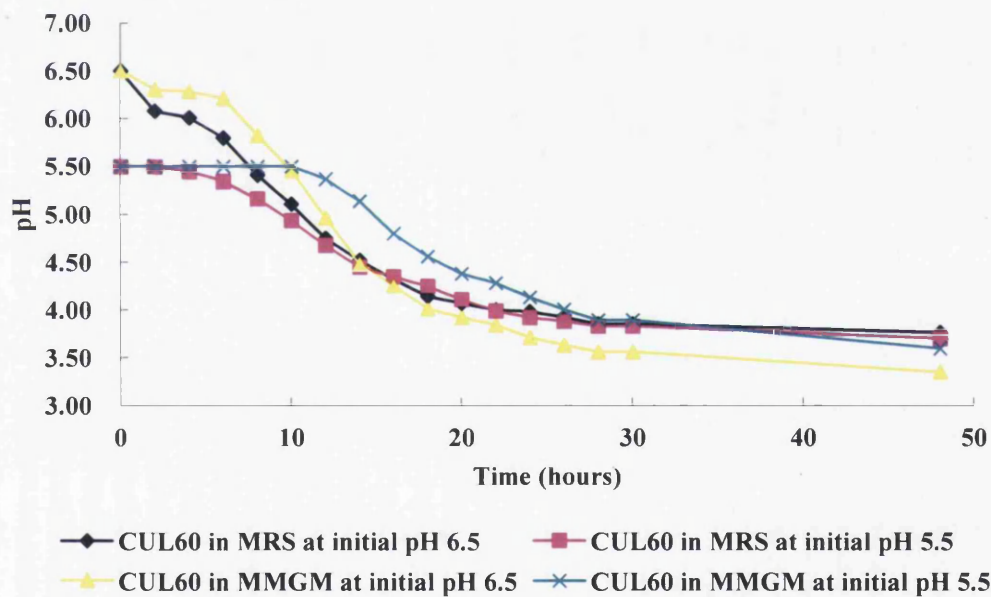
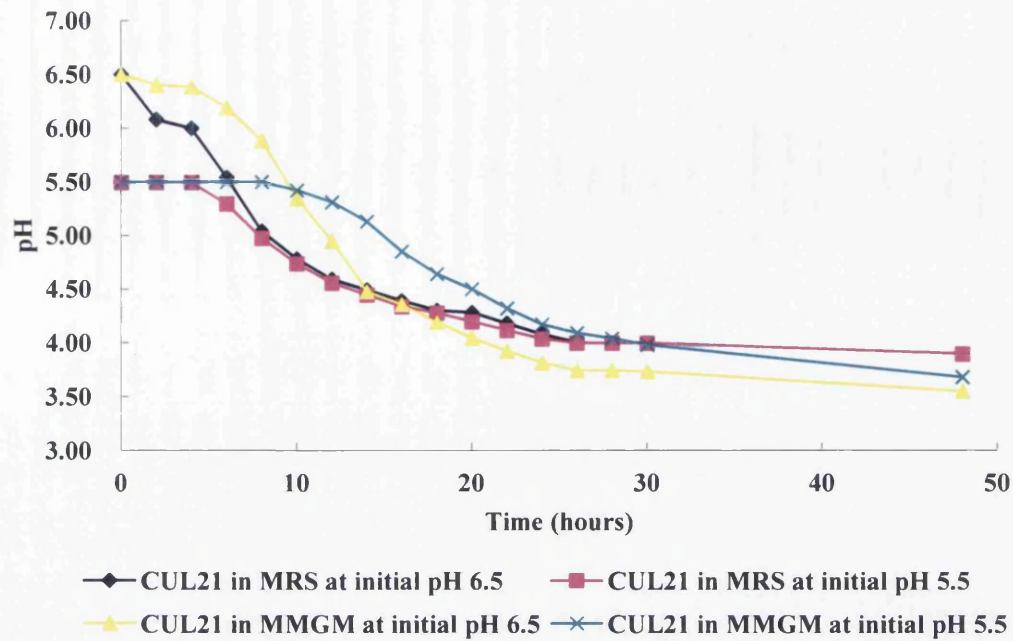

Figure 4.8: pH changes of *L.acidophilus* CUL60.

Figure 4.9: pH changes of *L. acidophilus* CUL21.Table 4.5: Estimation of growth parameters of *L. acidophilus* CUL60

Conditions	$\log_{10} (\text{cfu ml}^{-1})_0$	$A$	$\mu (\text{h}^{-1})$	$t_d (\text{h})$	$\lambda (\text{h})$
MRS at initial pH 6.5	5.95	2.86	0.62	1.11	2.00
MRS at initial pH 5.5	6.11	2.67	0.62	1.11	2.00
MMGM at initial pH 6.5	5.90	1.68	0.35	2.01	2.00
MMGM at initial pH 5.5	6.00	1.48	0.35	2.01	4.00
MMGM at controlled pH 6.5	6.08	2.00	0.32	2.15	0.00
MMGM at controlled pH 5.5	6.00	1.90	0.25	2.74	4.00

Parameters:  $\log_{10} (\text{cfu ml}^{-1})_0$  initial biomass;  $A$ , increase between initial and final biomass;  $\mu$ , maximum specific growth rate;  $t_d$ , biomass doubling time;  $\lambda$ , lag phase.

Table 4.6: Estimation of growth parameters of *L.acidophilus* CUL21

Conditions	$\log_{10} (\text{cfu ml}^{-1})_0$	$A$	$\mu (\text{h}^{-1})$	$t_d (\text{h})$	$\lambda (\text{h})$
MRS at initial pH 6.5	6.26	2.56	0.58	1.20	4.00
MRS at initial pH 5.5	6.48	2.35	0.64	1.08	2.00
MMGM at initial pH 6.5	6.38	1.45	0.28	2.51	2.00
MMGM at initial pH 5.5	6.34	1.24	0.32	2.15	4.00
MMGM at controlled pH 6.5	6.20	2.06	0.32	2.15	0.00
MMGM at controlled pH 5.5	6.08	1.84	0.28	2.51	4.00

Parameters:  $\log_{10} (\text{cfu ml}^{-1})_0$  initial biomass;  $A$ , increase between initial and final biomass;  $\mu$ , maximum specific growth rate;  $t_d$ , biomass doubling time;  $\lambda$ , lag phase.

The results in Figure 4.6, Figure 4.7, Figure 4.8 and Figure 4.9 show that the growth behaviour and pH trend of *L.acidophilus* CUL60 and CUL21 were the same. They both have the similar growth pattern with *L.salivarius* CUL61 and *L.paracasei* CUL08 under different culture conditions. They all have S shape growth curves. All the pH values dropped down from the initial pH to the end point (at around pH 3.5). However, the specific growth rates of CUL60 and CUL21 are higher than CUL08 and lower than CUL61 under different culture conditions. The biomass productions of CUL60 and CUL21 are higher than CUL61 and CUL08.

The maximum specific growth rate of CUL60 and CUL21 was similar on MMGM with uncontrolled and controlled pH (between 0.25-0.35  $\text{h}^{-1}$ ). There is only a short lag phase (0-4h) under different pH conditions, while CUL61 and CUL08 have a longer lag phase (8-10h) under the lower pH (5.5). It indicates that *L.acidophilus* CUL60 and CUL21 have higher acid tolerance and are less affected by the acid environment.

The optimal conditions for the growth of *L.acidophilus* CUL60 and CUL21 were still in MMGM with controlled pH 6.5 at 37°C. Under these conditions, the highest biomass and specific growth rates were observed.



#### 4.3.4 Growth of LAB4B and LAB4

##### 4.3.4.1 Growth of the mixture of *Bifidobacterium lactis* CUL34 and *Bifidobacterium bifidum* CUL20

The preliminary trials for the growth of CUL34 and CUL20 in MRSX or MMGM at different initial pH have also been completed. The results show CUL34 and CUL20 can grow in the MRSX broth and exhibit an S-shape growth curve (results are not shown in this Chapter due to the lack of space). The specific growth rates were quite low compared to lactobacilli. However, CUL34 and CUL20 did not grow very well in MMGM at batch culture fermentation. Both bifidobacteria could only survive in MMGM at initial pH 6.5 but they could not be detected in MMGM at lower pH (5.5). It may be because that bifidobacteria could not adapt to the acidic environment because the accumulation of fermentation products (e.g. SCFAs) reduced the pH in the closed batch fermentation system. Due to the lack of space, the results are not shown here. In order to maintain the survival of the bifidobacteria, the continuous stages fermentation model has been used to investigate the growth of bifidobacteria, which will be addressed in Chapter 5.

##### 4.3.4.2 Growth behaviour of LAB4B and LAB4

LAB4B and LAB4 strains of probiotic have been incorporated into many probiotic products in Cultech Ltd. LAB4 has benefits for people who suffer from IBS. LAB4B is of benefit for pregnancy and infants from birth to four years to prevent atopic sensitization and atopic eczema (Allen et al. (2010); Williams et al. (2009); Madden et al. (2005); Plummer et al. (2004, 2005)). In this initial trial, the growth behavior of co-cultured probiotic strains LAB4B or LAB4 was investigated in batch fermentation with modified Macfarlane's gut medium (MMGM) at initial pH 6.5 and 5.5 without pH control (See Section 4.2.2 and Section 4.2.8). Lactobacilli group and bifidobacteria growth profile were determined (Figure 4.10 and Figure 4.11). The pH was also monitored in these trials (Figure 4.12).

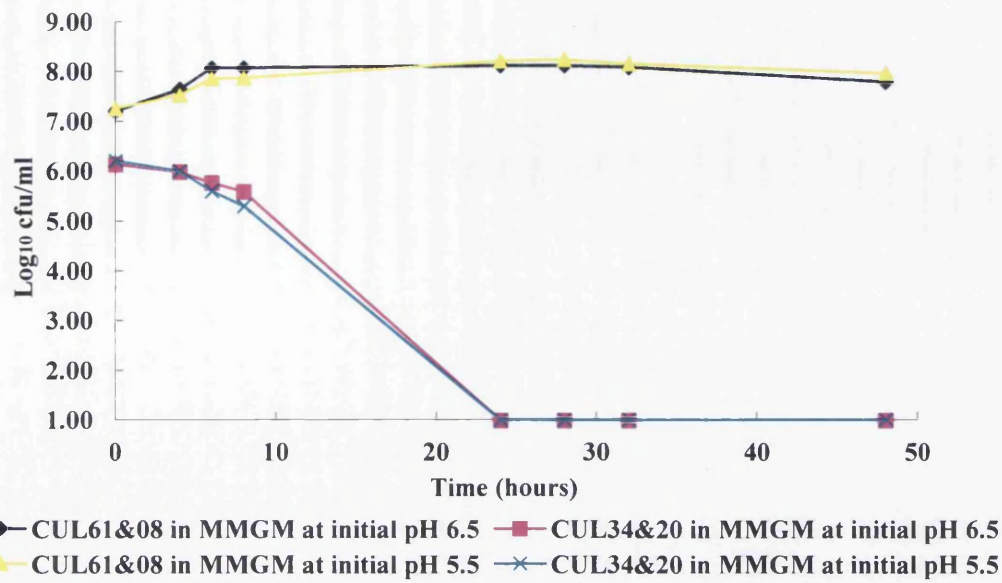

Figure 4.10 Growth of CUL61& 08 and CUL34&20 as two groups of LAB4B in MMGM at initial pH 6.5 and 5.5.

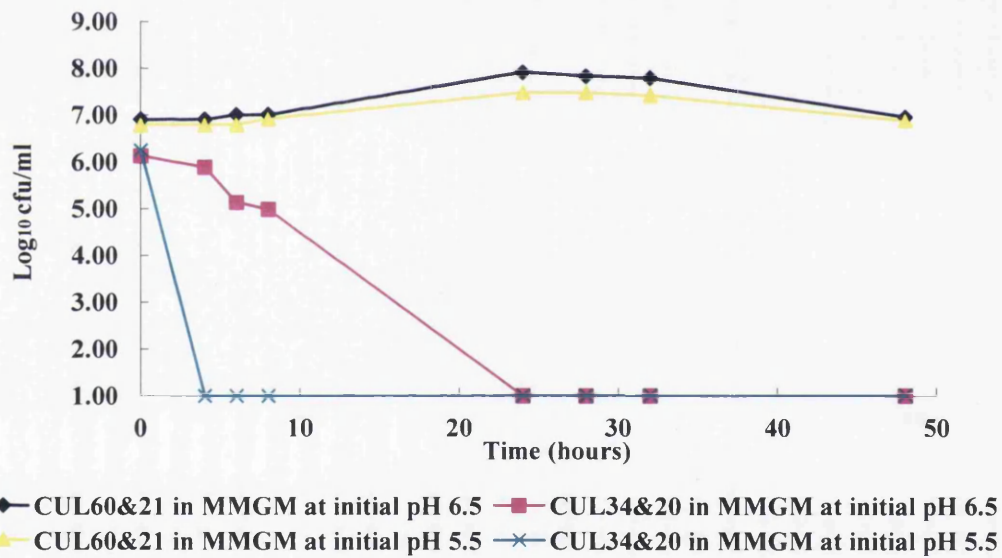

Figure 4.11 Growth of CUL60& 21 and CUL34&20 as two groups of LAB4 in MMGM at initial pH 6.5 and 5.5.

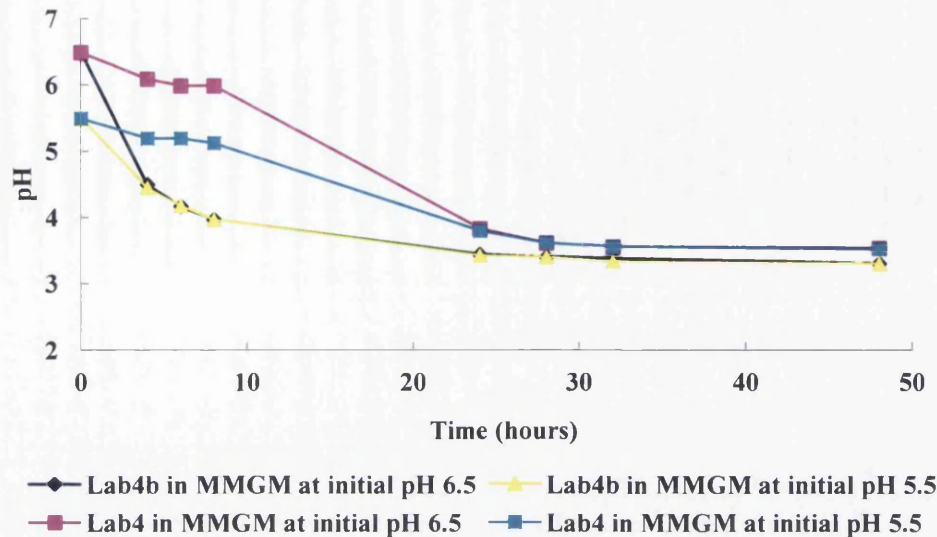

Figure 4.12: pH changes of LAB4B and LAB4 in MMGM

Table 4.7: Estimation of growth parameters of *Lactobacilli* group in MMGM at different initial pH

Conditions	$\log_{10}(\text{cfu ml}^{-1})_0$	$A$	$\mu$ ( $\text{h}^{-1}$ )	$t_d$ (h)	$\lambda$ (h)
CUL61&08 at initial pH 6.5	8.11	0.91	0.32	2.15	0.00
CUL61&08 at initial pH 5.5	8.23	0.97	0.23	3.01	0.00
CUL60&21 at initial pH 6.5	7.91	1.01	0.14	5.02	10.00
CUL60&21 at initial pH 5.5	7.48	0.70	0.09	7.53	10.00

Parameters:  $\log_{10}(\text{cfu ml}^{-1})_0$  initial biomass;  $A$ , increase between initial and final biomass;  $\mu$ , maximum specific growth rate;  $t_d$ , biomass doubling time;  $\lambda$ , lag phase.

The results in Figure 4.10 and Figure 4.11 show that the growth behaviours of lactobacilli groups are similar to the individual lactobacilli strains. They all have S-shape growth curves. CUL61 & 08 started the log phase (0-8h) without lag phase followed by the long stationary phase in MMGM batch fermentation. CUL60 & 21 had 10 hours lag phase before starting the log phase (10-24h), then followed by the stationary phase. This can also be verified by the pH drop pattern in Figure 4.12. The pH dropped sharply from 6.5 (5.5) to 3.5 during the log phase of CUL61 & 08 fermentation, but the pH decreased steadily from 6.5 (5.5) to 4.5 as CUL60 & 21 did not grow in the first 10 hours during the lag phase.

There is no lag phase of CUL61 & 08 co-cultures compared to the longer lag phase (4-8h) of their individuals at lower pH (5.5), which may be explained by their higher competition capacity in the batch fermentation system with the 4 strain mixture.

The specific growth rates of CUL61 & CUL08 together are higher than CUL60 & CUL21 in MMGM at both initial pH (Table 5.7). These all indicate that CUL61 & CUL08 have higher fermentation capacity compared to CUL60 & CUL21. Also it will take the co-culture of CUL60 & CUL21 a few hours to adapt in the gut medium environment and start to grow exponentially.

The results of Figure 4.10 and Figure 4.11 also showed that bifidobacteria groups maintained lower viable count in the first 10 hours batch fermentation and viable count dropped very fast after the lactobacilli went into the log phase. These co-cultures further proved that bifidobacteria could not adapt to the acidic environment (pH 5.5) as the accumulation of fermentation products (e.g. SCFAs) reduced the pH in the closed batch fermentation system. The continuous stages fermentation model will be used to investigate the survival of the bifidobacteria as explained in Chapter 5.

### **4.4 Discussion**

The physiology of probiotic bacteria are of interest for two reasons. First, during growth in the lower intestine, these organisms compete with other bacteria for available substrates, and the metabolic products (acetate and lactate) act to buffer the intestinal pH, thus inhibiting pathogens, and are absorbed by the host. Secondly, in the food or daily supplement industry, these bacteria are cultivated, either in situ in a food (e.g. yoghurt) or in a fermentor from which they may be harvested and added to a food as supplement. In this case, it is useful to extend our knowledge of the metabolic behavior of different probiotic strains and investigate the kinetic parameters on their own or their co-cultures.

Mlobeli et al. (1998) illustrated that *Bifidobacterium bifidum* can metabolise a range of different sugars, among which glucose is clearly superior in terms of growth rate, biomass concentration and yield, and metabolite formation. In addition, their results demonstrated a major effect of pH on biomass production. Most studies carried out with lactobacilli and bifidobacteria have used complex media, such as TPY (Trypticase-Phytone-Yeast extract) or MRS, to which one or several carbohydrates were added (McKellar et al. (1989); Desjardins et al. (1990); Wang et al. (1993); Gibson et al. (1994b); Hopkins et al. (1998); Sghir et al. (1998); Kaplan et al. (2000)). Based on these studies, it is noted that in a medium such as TPY, the bifidobacteria could grow without any addition of carbohydrates. This means that the results observed with complex media to which carbohydrates had been added could not be due to this supplement alone but to some other components of the medium. Perrin et al. (2001) compared the physiological behaviour of *Bifidobacterium infantis* growing on synthetic oligofructose, glucose and fructose. In his study on a pure culture of *B. infantis*, glucose was the best substrate for growth and global biomass production but less so for the production of major metabolites.

Based on the literature investigation, the present studies were carried out on a modified Macfarlane's gut medium with glucose as the sole carbohydrate. In this study, modified Macfarlane's gut medium (MMGM) with and without pH control at either 6.5 or 5.5 has been used to investigate the growth behaviour of 4 lactobacilli probiotic strains. MRS broth at either initial pH 6.5 or 5.5 was also used as control. In these fermentations, it is clear that there are similar growth patterns of all 4 lactobacilli strains under different conditions. All these batch fermentations have an S-shaped growth curve in the low cell densities inoculation. All the pH dropped down from initial pH (6.5 or 5.5) to the end point at around pH 3.5.

MRS broth affected the final biomass and specific growth rate significantly because the higher nutrition of MRS broth is available compared with MMGM. Without considering the fermentation in MRS broth, the maximum biomass yield and specific growth rate were both observed in MMGM at controlled pH 6.5 and the lowest

values were observed with uncontrolled pH 5.5. It is observed that the controlled pH 6.5 of the MMGM have significant effects on all growth parameters tested (increases of biomass, specific growth rate, reduces lag phase and the doubling time).

The optimal conditions for the growth of *L.salivarius* CUL61 were MMGM with controlled pH 6.5 at 37°C. Under these conditions, the highest biomass and specific growth rates, together with shorter lag phases and doubling time, were obtained. The growth behaviour of *L.paracasei* CUL08 is similar to *L.salivarius* CUL61 under different culture conditions. However, the specific growth rates of CUL08 are all lower than CUL61 which results in the higher doubling time of CUL08. It means CUL61 grow faster than CUL08 in any tested culture conditions. Both CUL61 and CUL08 had a relative longer lag phase (8-10h) in MMGM at controlled pH 5.5 than pH 6.5. It may indicate that the lower pH (5.5) will delay the log phase. After the bacteria were acclimated to the environment conditions, the biomass production and the specific growth rate were relatively consistent.

There is no major difference of the growth behaviour of *L.acidophilus* CUL60 and CUL21 under different conditions. CUL60 & 21 has a shorter lag phase (0-4h) than the CUL61 and CUL08 (8-10h) at the lower pH (5.5). It indicates that *L.acidophilus* CUL60 and CUL21 may have higher acid tolerance than CUL61 and CUL08. CUL60 and CUL21 are less affected by the acid environment.

The growth behaviors of co-cultured probiotic strains LAB4B or LAB4 were also investigated in the modified Macfarlane's gut medium (MMGM) at initial pH 6.5 and 5.5. It is found that the growth behaviors of lactobacilli groups were similar to the individual lactobacilli strains. However, the viable counts of bifidobacteria groups dropped very quickly after the lactobacilli group went into the log phase. It may be because that bifidobacteria could not adapt to the acidic environment as the accumulation of fermentation products (e.g. SCFAs) reduced pH in the closed batch fermentation system. In order to maintain the survival of bifidobacteria, the continuous stages fermentation model with fresh medium and controlled pH is used to investigate the growth of bifidobacteria, and this will be addressed in Chapter 5.

---

## 4.5 Conclusion

An *in vitro batch* fermentation model was employed to investigate the growth behavior of individual lactobacilli strains in combinations of two culture media (MRS broth or MMGM), two uncontrolled pH values (6.5 or 5.5) and two controlled pH values (6.5 or 5.5) at 37°C. The growth parameters and pH trend were monitored during the series of experiments. The results suggest that glucose sustains growth and cell production. MMGM with controlled pH 6.5 led to the highest growth rate and cellular yield, whereas MMGM with uncontrolled pH 5.5 was the worst condition for the probiotic growth. The results demonstrate a major effect of pH on biomass production. Hence, production processes should pay attention to this parameter. The use of pH control would be necessary to maintain high growth rates and yields.

However, the *in vitro batch* fermentation model is not suitable for the co-culture of lactobacilli and bifidobacteria as it becomes deplete of nutrient supply over time and together with the accumulation of toxic products, results in arrested growth. Complex experimentation such as the microbial community and microbial metabolic modulation requires single or multi-stage continuous fermentation models for nutrient replenishment, as substrate depletion restricts the operational time of batch fermentations to several hours and prevents the establishment of steady-state conditions *in vitro*.

# Chapter 5 Growth of Mixture Strains with Probiotic in an *In Vitro* Continuous Fermentation Model

## Abstract

The aim of this part of the work is to develop an *in vitro* continuous fermentation system as a simplified model to simulate the physicochemical environment of the human colon. This system is highly flexible allowing frequent sampling and long-term studies under a controlled environment without disruption to the anaerobiosis. The entire fermentation apparatus is maintained inside a specially designed anaerobic workstation with a gaseous mixture of 80% N<sub>2</sub>, 10% CO<sub>2</sub> and 10% H<sub>2</sub>. The *in vitro* continuous fermentation system, which consists of commercially available probiotic strains and 3 residential microbial strains in the human gut, is used to investigate the stability of microbiota composition and survivability of probiotic. The experiments simulate the interaction between the probiotics and the residential microflora and show that the addition of probiotic does not affect significantly the total number of bacteria growing in the continuous culture. The growth data obtained in these experiments are then used to validate the new mathematical model of the microbial ecosystem in the human GI tract, and the details will be explained in later chapters.





## 5.1 Introduction

Bifidobacteria and lactobacilli are predominant bacteria of the gut microbiota and are well known for their beneficial and health promoting properties (Suvarna et al., 2005). These bacteria could produce acetate and lactate, which can be converted to propionate and butyrate through cross feeding by other bacteria (e. g. *Eubacterium halii*, *Faecalibacterium prausnitzii*) (Duncan et al. (2004); Belenguer et al. (2006); Morrison et al. (2006)). SCFA can lower the gut pH and may inhibit pathogens. In addition, they are nutrients for the colonic epithelium after absorption by the colonocyte, and also impact on the gastrointestinal disease such as IBD, colitis and colon cancer (Cook et al. (1998); Gibson et al. (1999)).

Various different *in vivo* and *in vitro* approaches have been used to evaluate the efficacy of probiotic. It is important that the survivability should be determined in the 'challenge tests'. The ultimate test for probiotic functionality is the *in vivo* model such as laboratory animals or well-controlled humans. Animals, usually rats or mice have been used to investigate the effect of substrate on the gut microbiota. Gnotobiotic rats have also been used to investigate the interactions between the host and the microorganisms. Human flora-associated rats give a representation of the environment in the human colon. However, difference exists between animal and human microbiota that makes comparative results difficult. Obviously, the best model is a well-controlled human trial with placebo control and double-blind samples. However, drawbacks still exist and the trials may be difficult and expensive to set up (Gibson et al., 2000).

Since the healthy intestine is not easily accessible for most research purposes, attempts have been made to simulate the intestinal microbial ecosystem *in vitro*. Batch culture allows short periods (24-48h) fermentation of various substrates. However, marked differences between the ascending and descending colon exist in substrate availability and environmental conditions, which cannot be simulated in a batch fermentation model (Allison et al., 1989). In contrast, *in vitro* systems using

---

multi-stage systems to permit spatial or temporal heterogeneity have advantages to model more complex environmental conditions (Marsh et al., 1995).

The multistage system has clear economical advantages and is also versatile to suit various study purposes. So far, several authors have described successfully a continuous multi-stage culture system for simulating the microbial community in the large intestine (Gibson et al. (1988a); Molly et al. (1993); Macfarlane et al. (1998); Cinquin et al. (2004); Belenguer et al. (2006); Chassard et al. (2006); Zihler et al. (2010); Van den Abbeele et al. (2010)). These systems have been employed to study the dynamics of bacterial populations, the actions of probiotic bacteria, and other features of the human GI tract (Freter (1983d); Alander et al. (1999)). The advantages include accessibility and ability to reproduce a range of environmental and nutritional parameters characteristic of the ascending and descending colons. The composition and retention time of supply of the growth medium can be easily controlled. The microbiota responses to changing substrate availabilities and other environmental conditions can be investigated together with effects of introducing defined populations and marked strains of bacteria (Olano-Martin et al. (2000); Hopkins et al. (2003)).

The typical *in vitro* continuous fermentation models such as the Reading model (Gibson et al., 1988a) and the simulated human intestinal microbial ecosystem (SHIME) (Molly et al., 1993) have a similar design. This design facilitates the spatial, temporal, nutritional and physicochemical properties of the gut microbiota by combining a few vessels in series representing the small intestine and the large intestine. Adaptation, survival and proliferation of gut microbiota in an *in vitro* continuous fermentation models are dependent on strict control of environment such as pH, temperature, retention time, anaerobiosis and flow rate etc. (Payne et al., 2012a). Strict control of these parameters will help to establish a steady-state environment for both microbial composition and metabolic activities. With this steady-state condition established, a reproducible system is achieved for studying the

gut microbial community modulation and metabolic function. More information regarding the *in vitro* continuous fermentation models can be found in Chapter 2.

A further development of an *in vitro* model to simulate the bacterial adhesion on the mucus layer in the human colon has been made recently by the SHIME group, in Gent University, Belgium. In the M-SHIME, a mucosal compartment (mucin-covered microcosms coated with mucin type II-agar) has been introduced in the ascending colon vessel to reproduce the bacterial adhesion to the gut wall mucus (Van den Abbeele et al., 2012). This improvement may lead to more *in vivo*-like communities in such dynamic long-term *in vitro* simulations and allow evaluation of the colonization of unique mucosal microbiota in health and disease (Van den Abbeele et al., 2012). Although this is a novel developed model to simulate the mucus-associated fermentation in the human colon, the big disadvantage is that the whole system will lose the anaerobic environment after the mucin-covered microcosms are taken out from the fermentation vessel. All the experiments are then exposed to atmospheric oxygen and the whole process must be terminated. This restricts the long-term dynamic fermentation in the M-SHIME model.

A major achievement of this project is the establishment of a uniquely designed *in vitro* continuous fermentation model in which the entire fermentation apparatus is maintained inside a tailor made anaerobic workstation filled with a gaseous mixture of 80% N<sub>2</sub>, 10% CO<sub>2</sub> and 10% H<sub>2</sub>. This unique design allows easy processing, culture and examination of samples without exposure to atmospheric oxygen. The system facilitates adding and removing samples from the vessels in an absolute oxygen-free environment, and supports long-term dynamic fermentation trials.

In this work, a two-stage continuous culture-based model is developed for the growth of probiotic strains and three residential microbial strains in the human colon, which serves as a simplified model to investigate the effect of interaction between these microorganisms. The aims of this work are twofold. The first objective is to investigate the competitive abilities and survivability of commercially available probiotic strains in the simplified continuous fermentation model. In the same

---

experiment, therefore, the survival of three marked residential strains in the human colon was examined following their introduction into the continuous stages fermentation model. The second aim is to prepare first-hand data for validating the mathematical model of human GI tract, which will be introduced in later chapters.

## 5.2 Design of an *in vitro* continuous fermentation model

### 5.2.1 A novel designed anaerobic workstation

An anaerobic workstation (Figure 5.1) has been specially designed according to the project requirement. It has many unique features to assure good safety and economy of operation and to make it more convenient for the operator to use. The entire fermentation apparatus is maintained inside the anaerobic workstation with a gaseous mixture of 80% N<sub>2</sub>, 10% CO<sub>2</sub> and 10% H<sub>2</sub> to help to easily process, culture and examine samples without exposure to atmospheric oxygen.

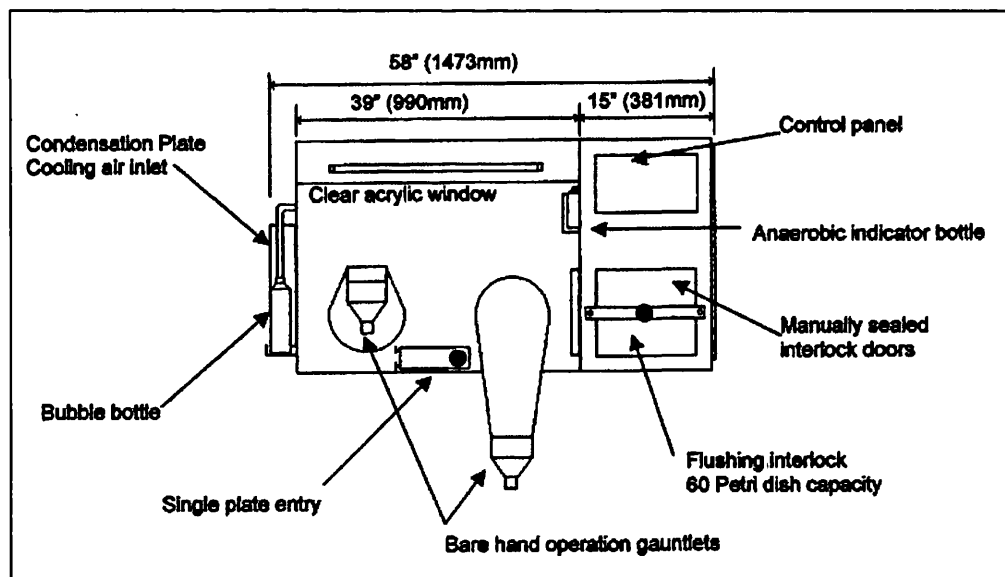

Figure 5.1: Schematic diagram of the anaerobic workstation

This specially designed anaerobic workstation has a removable front panel that allows moving the big pieces of equipment into the chamber. It has several airtight glands fitted in the ceiling of the chamber to allow cables and tubes to be introduced

from outside to inside without compromising internal conditions. The workstation is fitted with two electrical outlets/sockets. One of these is used for the anaerobic indicator pump and the other is for operation of any internal equipment. This socket supplies an extension with 10 sockets so that the pH controllers, the peristaltic pumps and the magnetic stirrers can be located internally.

The length of the workstation is 1473 mm giving more room inside the incubator section of the unit. This will be an advantage for fixing the pipes, tubes, sensors and pumps etc. that need installing inside the unit. The large 14 liter interlock chamber with internal door provides effective sample and equipment transfer in the fastest possible time whilst ensuring the minimum amount of oxygen is introduced into the incubator chamber. A high level of illumination is provided within the chamber. All internal fittings have been designed to make intelligent use of the available space, whilst ensuring unimpeded arm movement. A detoxification system provides the best possible growth conditions and prolongs catalyst life in the anaerobic workstation. A bespoke trolley is available in the airlock chamber to facilitate movement of the equipment.

### **5.2.2 Single-stage continuous fermentation model**

The single fermentor culture vessel 500 ml (Q. No.FV500 borosilicate glass culture vessel, VWR International Ltd., UK) covered by the lid with 5 ports (Q. No. MAF1/75 borosilicate glass flask cover, VWR International Ltd., UK) was connected to a source of fresh modified Macfarlane's gut medium (MMGM) and to an exit port for the collection of spent medium. Flow in the system was maintained by a peristaltic pump (RZ-77120-32 PUMP MFLEX C/L 6-RPM 115/230, Cole-Parmer, USA), which was set to assure one complete medium change (250 ml) every 24 hours. An autoclavable pH electrode (51343111 pH ELECTRODE INLAB POWDER PRO, VWR International Ltd, UK) with the cable (662-1240 Cable ISM-Multi Pin 1.8m, VWR International Ltd, UK) connected to a pH controller (RZ-56022-87 DLX pH-RX/MBB SERIES METERING PUMP, Cole-Parmer, USA) provided continuous monitoring and servo-controlled addition of 1N NaOH to

---

maintain the pH at the set point 5.5. The vessel was continuously stirred by the mini stirrer (FB70800 E-STEM Standard MiniStirrer, Fisher Scientific, UK). Fresh medium in the reservoir was maintained at pH 5.5.

The system consisting of the MMGM and 3 important intestinal strains (Table 5.1) was controlled at pH 5.5 to mimic the conditions of the ascending colon. The entire fermentation apparatus was maintained inside the anaerobic workstation. Figure 5.2 shows the single-stage continuous flow fermentation model.

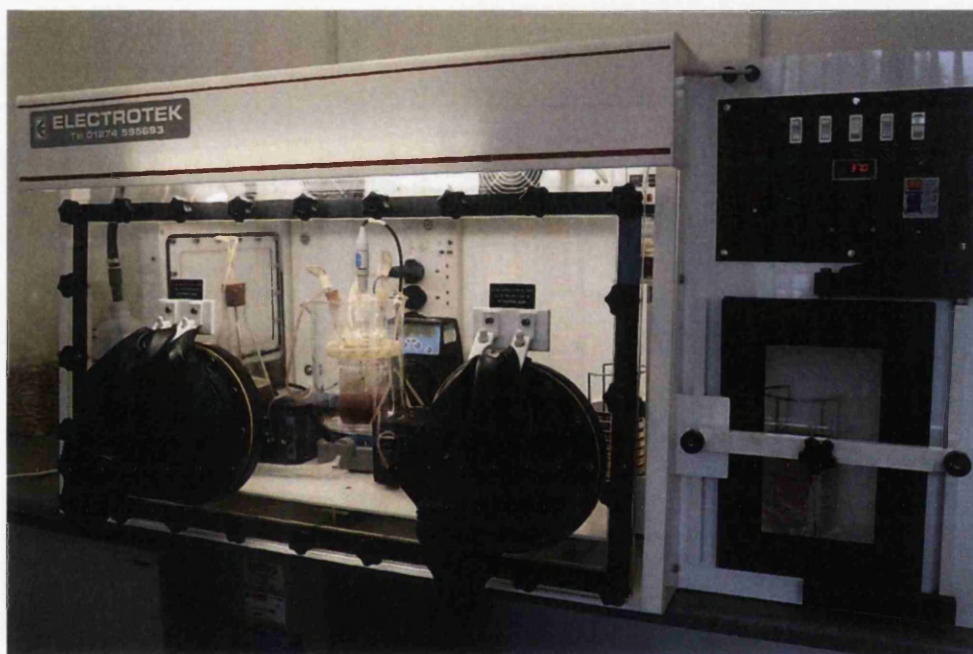

Figure 5.2 The single-stage continuous flow fermentation model.

Following 1% (2.5 ml) of overnight broth of *E.coli* QC1, *E. cloacae* QC4 and *E. faecalis* QC9 inoculation into the single culture vessel with 250 ml MMGM, the system was left at least 24 h as a batch culture to enable stabilization of microbial populations. Growth medium (MMGM) was introduced into the culture vessel 24 h after inoculation of the above 3 strains, and the medium flow rate was equivalent to one turnover per day, which gave a dilution rate of  $0.042 \text{ h}^{-1}$ . Simultaneously each capsule (See Section 5.2.5) of LAB4B or LAB4 was administered separately to the culture vessel. The whole system was run for 8 days (192 h) and 5 ml of fermentation culture was sampled daily. The bacterial population was enumerated by using

standard selective media (see Table 5.1) and characterized and identified by screening the profile (See Section 5.2.6). The collected samples were centrifuged ( $5,000 \times g$ , 10 min) to remove the microbial cells. The glucose residue in the culture medium was measured by glucose test kits (See Section 5.2.7).

### 5.2.3 Two-stage continuous fermentation model

The two-stage continuous fermentation model was developed to simulate the basic environment of ascending colon and descending colon which are around pH 5.5 and 6.5 respectively. The system comprised two glass vessels aligned in series. The first vessel (500 ml, the same as Section 5.2.2) in the system had an operating volume of 250 ml with the growth medium (MMGM) introduced into it. The second vessel also had an operating volume of 250 ml and was sequentially fed from the first vessel through the peristaltic pump. Culture medium from the second vessel was pumped to the waste reservoir. Each vessel was continuously stirred. The pH of the vessels was maintained at 5.5 and 6.5 for vessels 1 and 2 respectively, by the addition of 1N NaOH using pH controllers. The entire system (medium reservoir and waste reservoir included) was operated in the anaerobic workstation. The volume of the medium in both vessels was kept constantly at 250 ml and the flow rate of fresh medium was set equivalent to one turnover per day, which gave a dilution rate of  $0.042 \text{ h}^{-1}$ . Figure 5.3 shows the two-stage continuous fermentation model.

Two experiments were carried out using the two stages continuous fermentation model with either LAB4B or LAB4 as test probiotic strains. Each vessel contained 250 ml MMGM with inoculation of 1% (2.5 ml) of overnight broth of *E.coli* QC1, *E. cloacae* QC4 and *E. faecalis* QC9. Vessels 1 and 2 were left at least 24 h as a batch culture to enable stabilization of microbial populations. After this stabilization period, a fresh growth medium (MMGM) was introduced into vessel 1 and continuously fed to vessel 2, at a rate controlled by the peristaltic pump. The flow rate should be constant and maintain a complete medium change (250 ml) every 24 h. The flow rate was  $10.4 \text{ mlh}^{-1}$  and the dilution rate was  $0.042 \text{ h}^{-1}$ . Simultaneously

each capsule (See Section 5.2.5) either LAB4B or LAB4 was added separately to the vessel 1 and 2. The whole system was run 10 days (240 h) and 5 ml of fermentation culture were sampled daily. The bacterial population was enumerated by using standard selective media (See Table 5.1). The collected samples were centrifuged ( $5,000 \times g$ , 10 min) to remove the microbial cells. The glucose residue in the culture medium was measured by glucose test kits (See Section 5.2.7).

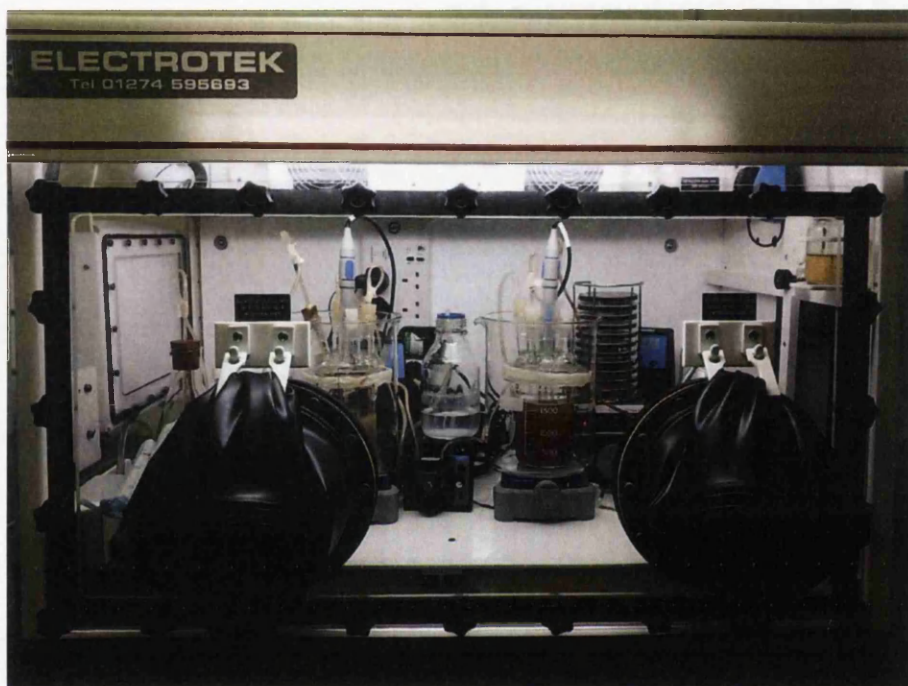

Figure 5.3 The two-stage continuous fermentation model

#### 5.2.4 Continuous culture microbiota

The microbiota introduced into the fermentation system consists of 3 residential strains belonging to species most commonly isolated from the human GI tract. These include *Escherichia coli* QC1 (NCTC10002), *Enterobacter cloacae* QC4 (NCTC10005) and *Enterococcus faecalis* QC9 (NCTC12697) which were provided by Obsidian Research Ltd.

To prepare overnight broth of these 3 strains, the organisms were grown from freezer stocks. Each organism was streaked out onto the appropriate medium from the



freezer stock and incubated aerobically at 37°C for 24 h. A single colony was selected from the plate and inoculated into 10 ml nutrient broth (CM0001, Oxoid, UK) and incubated aerobically at 37°C for overnight. Table 5.1 gives an overview of the microbial groups, the selective media and incubation conditions.

Enumeration of microorganisms was done by serial dilution in Maximum Recovery Diluent (MRD) and spread plating onto the following solid culture media: MacConkey agar (CM0007, Oxoid, UK) for *Escherichia coli* and *Enterobacter cloacae*; Kanamycin Aesculin Azide Agar (KAA) (CM0591, Oxoid, UK) for *Enterococcus faecalis*. The bacteria were enumerated after aerobic incubation at 37°C for 24 hours.

Table 5.1 Media and incubation conditions used for enumeration of continuous culture microbiota

Microbiota	Ref No.	Medium*	Incubation conditions
<i>Escherichia.coli</i>	QC1	MacConkey agar	Aerobic, 37C, 24h
<i>Enterobacter cloacae</i>	QC4	MacConkey agar	Aerobic, 37C, 24h
<i>Enterococcus faecalis</i>	QC9	KAA agar	Aerobic, 37C, 24h
<i>Lactobacillus salivarius</i>	CUL61	MRS	Anaerobic, 37C, 72h
<i>Lactobacillus paracasei</i>	CUL08	MRS	Anaerobic, 37C, 72h
<i>Lactobacillus acidophilus strain 1</i>	CUL60	MRS	Anaerobic, 37C, 72h
<i>Lactobacillus acidophilus strain 2</i>	CUL21	MRS	Anaerobic, 37C, 72h
<i>Bifidobacterium animalis subsp lactis</i>	CUL34	MRS-MUP	Anaerobic, 37C, 72h
<i>Bifidobacterium bifidum</i>	CUL20	MRS-MUP	Anaerobic, 37C, 72h

\*The detail of each medium can be found in Section 5.2.4 and Section 4.2.1.

### 5.2.5 Commercially available probiotic strains

The commercial probiotic product of LAB4B and LAB4 were provided in the form of gelatine capsules containing a freeze-dried mixture of lactobacilli and bifidobacteria provided by Cultech Ltd., UK. Each capsule of LAB4B consists of *Lactobacillus salivarius* (CUL61) ( $2.5 \times 10^9$  cfu), *Lactobacillus paracasei* (CUL08) ( $2.5 \times 10^9$  cfu), *Bifidobacterium animalis subsp Lactis* (CUL34) ( $0.25 \times 10^9$  cfu) and *Bifidobacterium bifidum* (CUL20) ( $4.75 \times 10^9$  cfu). The total viable count of LAB4B is  $1 \times 10^{10}$  cfu/capsule. Each capsule of LAB4 consists of *Lactobacillus acidophilus* strain 1 (CUL60) and *Lactobacillus acidophilus* strain 2 (CUL21) ( $3 \times 10^{10}$  cfu), *Bifidobacterium animalis subsp Lactis* (CUL34) ( $1 \times 10^9$  cfu) and *Bifidobacterium bifidum* (CUL20) ( $1.9 \times 10^{10}$  cfu). The total viable count of LAB4 is  $5 \times 10^{10}$  cfu/capsule. Enumeration of probiotic strains was done by serial dilution in MRD and spread plating onto the different solid culture media. Table 5.1 shows the organisms and the selective media and incubation conditions used.

### 5.2.6 Screening the profile of mixture strains

#### 5.2.6.1 Gram stain

A 1 ml disposable sterile pipette was used to place one drop of sterile water onto a microscope slide. A single colony from a relative agar plate was picked and smeared into a drop of water to mix well, until it became a homogenous milky solution. The slide was allowed to air dry before it was passed over a flame source to heat-fix. Then it was flooded with Crystal Violet Oxalate solution (BioMerieux, Basingstoke, UK) for 1 minute. Next, the slide was washed with sterile water and flooded with stabilized Gram's Iodine solution (BioMerieux, Basingstoke, UK) for 2 minutes. Following further washing with de-colorizing solution (25% acetone, 75% iso-propanol), sterile water was washed over the slides. Finally, the slide was flooded with Safranin solution (BioMerieux, Basingstoke, UK) for 1 minute and then washed with sterile water. When the slide is dry, it was viewed using an x100 oil immersion lens under an optical microscope (Ceti, Belgium).

---

### 5.2.6.2 Biochemical identification

If the organism type could not be conclusively identified by Gram stain alone, further biochemical identification was carried out using the Analytical Profile Index (API) biochemical identification system (BioMerieux, Basingstoke, UK). The API is a miniaturized panel of biochemical tests compiled for identification of groups of closely related bacteria. APIs were prepared and read according to the manufacturer's instructions. The reactions are read according to the reading table and identification is obtained by using the identification software which can be accessed through the API website. The result indicates the percentage likelihood of a named organism being present. Table 5.2 lists the API types used for different colony type classification.

Table 5.2 API biochemical tests and Organisms identifiable

API	Organism Classification	Organism Species
RapID 20E	Gram Negative Organisms	<i>Acineto/Pseudo</i> spp. <i>Enterobacter</i> spp. <i>Escherichia</i> spp. <i>Serratia</i> spp. <i>Shigella</i> spp.
Rapid ID 32A	Anaerobic organisms	<i>Actinomyces</i> spp. <i>Bacteroides</i> spp. <i>Bifidobacterium</i> spp. <i>Clostridium</i> spp. <i>Eubacterium</i> spp. <i>Fusobacterium</i> spp. <i>Peptostreptococcus</i> spp. <i>Prevotella</i> spp. <i>Propionibacterium</i> spp.
API 50CHL	Facultative Gram Positive organisms	<i>Lactobacillus</i> spp. <i>Leuconsostoc</i> spp. <i>Pediococcus</i> spp.

### **5.2.6.3 RAPD-PCR (Random Amplification of Polymorphic DNA- Polymerase Chain Reaction)**

RAPD-PCR is a rapid fingerprinting method that has already been used by several researchers for lactobacilli differentiation (Du et al. (1995); Roy et al. (2000); Tynkkynen et al. (1999)) and thus may represent a good technique for the molecular characterization and identification of probiotic strains. The standard RAPD technology utilizes short synthetic oligonucleotides (10 bases long) of random sequences as primers to amplify nano-gram amounts of total genomic DNA under low annealing temperatures by PCR. This primer may bind in several places in any one genome on either strand of DNA, allowing amplification of several bands, of different lengths during a single reaction. It is unknown where the primer will bind and therefore what pattern of banding will occur; however when the same DNA template is used with the same primer the same banding pattern will always occur. Thus if a different DNA template is used a different pattern will result. This allows us to uniquely identify a strain of bacteria for example, even if the species is the same, since each strain has a different genome. This technique can be used to track probiotic organisms, for example by comparing the patterns from isolates from unknown samples with the known controls we can identify which samples are positive for the probiotic organisms. RAPD-PCR for different probiotic organism's identification in this study is followed the internal work protocol in Obsidian Quality Manual.

### **5.2.7 Glucose content**

As the glucose is the sole carbohydrate source in the modified Macfarlane's gut medium (MMGM), the glucose residue either in the single or two stages fermentation trial will be tested according to the D-glucose test kits instruction (Cat.No. 10716251035, R-biopharm, Germany). It is a UV-method for the determination of D-glucose in food stuffs and other materials such as fermentation samples. The principle of this test is that D-glucose is phosphorylated to D-glucose-6-phosphate (G-6-P) in the presence of the enzyme hexokinase (HK) and

---

adenosine-5'-triphosphate (ATP) with the simultaneous formation of adenosine-5'-diphosphate (ADP). The fermentation sample should be centrifuged and the supernatant (diluted according to the dilution table in the test kits instruction) will be used for assay. The absorbance of the solutions before and after reaction has been measured at 340 nm, the content of D-glucose is calculated based on the equation below.

$$c = \frac{V \times MW}{\epsilon \times d \times v \times 1000} \times \Delta A \text{ [g/l]}$$

c = concentration of D-glucose [g/l];

V = final volume [ml] (3.020 ml);

v = sample volume [ml] (0.100 ml);

MW = molecular weight of the substance to be assayed [g/mol] (D-glucose = 180.16);

d = light path [cm] (1 cm);

$\epsilon$  = extinction coefficient of NADPH at 340 nm [ $l \times \text{mmol}^{-1} \times \text{cm}^{-1}$ ] (6.3);

$\Delta A = (A_2 - A_1)_{\text{sample}} - (A_2 - A_1)_{\text{blank}}$  (subtract the absorbance difference of the blank from the absorbance difference of the sample).

If the sample has been diluted during preparation, the result must be multiplied by the dilution factor F.

## 5.3 Results

### 5.3.1 Pre-trial of the stabilization of 3 residential strains

In order to obtain the stabilization environment using 3 residential strains in the MMGM, the single continuous culture fermentation was carried out in the anaerobic workstation as described by Section 5.2.2. Following 1% (2.5 ml) of overnight broth

---

of *E.coli* QC1, *E. cloacae* QC4 and *E. faecalis* QC9 inoculation into single culture vessel containing 250 ml MMGM, the system was left at least 24 h as a batch culture to enable stabilization of microbial populations. Growth medium (MMGM) was introduced into the culture vessel at 24 h after inoculation of the above 3 strains, and the medium flow rate is equivalent to one turnover per day, which gave a dilution rate of  $0.042 \text{ h}^{-1}$ . The system was set at pH 5.5 to mimic the acid condition of the ascending colon. The whole system was run 7 days (168 h) and 5 ml of fermenter culture was sampled daily, and the bacterial population was enumerated by using standard selective media (see Table 5.1).

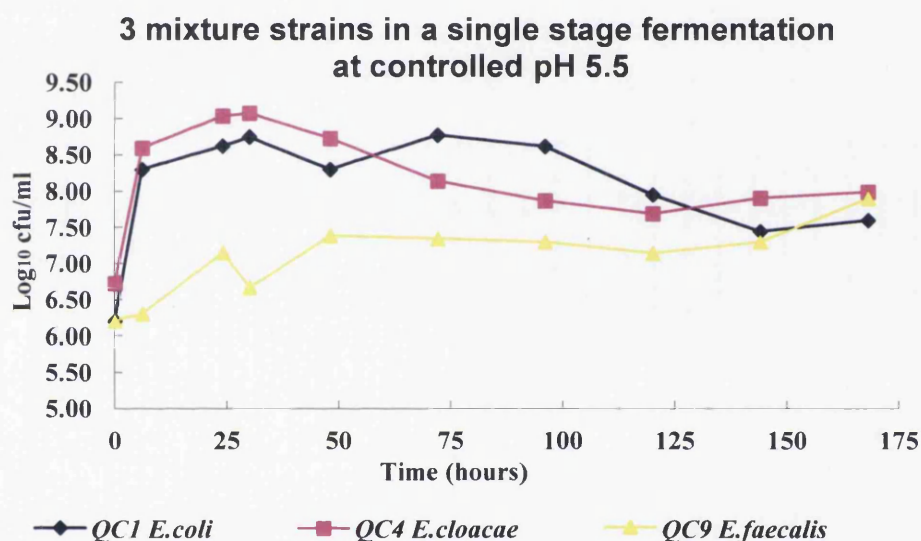

Figure 5.4: Growth of 3 mixture strains in the single-stage continuous fermentation at controlled pH 5.5 over the experimental period.

These bacterial groups were found to be relatively constant after the exponential log phase in the first 24 hours (Fig. 5.4). The bacteria viable count is ranging from 8.78 to 7.45  $\log_{10} \text{ cfu ml}^{-1}$  for *E. coli*, and 9.08 to 7.70  $\log_{10} \text{ cfu ml}^{-1}$  for *E. cloacae*, and 7.15 to 7.90  $\log_{10} \text{ cfu ml}^{-1}$  for *E. faecalis* between 24 h and 168 h. During this trial, it is assumed that the steady state will be reached 24 hours after incubation of the 3 residential strains in the single-stage fermentation model.

### 5.3.2 Single-stage continuous fermentation with LAB4B

Following the procedure of single-stage continuous fermentation trial (See Section 5.2.2), the system will become steady state 24 hours after incubation with 1% (2.5 ml) of overnight broth of *E.coli* QC1, *E. cloacae* QC4 and *E. faecalis* QC9. Then, growth medium (MMGM) was introduced into the culture vessel with controlled pH 5.5 and the flow rate was set equivalent to one turnover per day. Simultaneously, one capsule of LAB4B was administered to the culture vessel and the amounts added to the system contained between  $10^7$  and  $10^8$  viable bacteria per ml for each probiotic strain. The whole system was run 8 days (192 h) and 5 ml of fermentation culture was sampled daily. Bacterial counts were obtained for each bacterial species by using the selective media (see Table 5.1). The bacterial population was characterized and identified by screening the profile (see Section 5.2.6). The glucose residue in the culture medium was measured by glucose test kits (see Section 5.2.7).

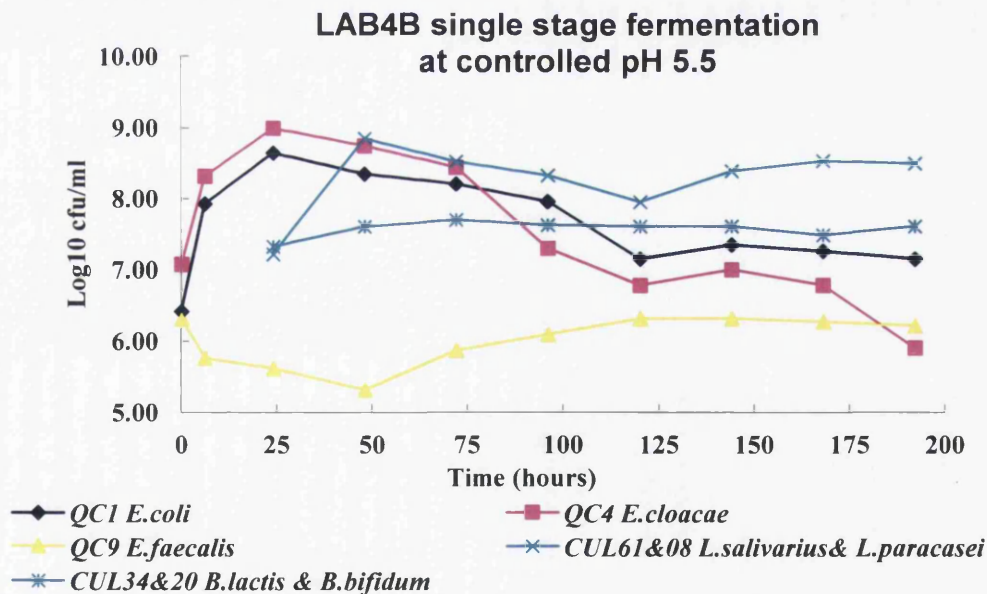

Figure 5.5: Growth of 3 mixture strains and LAB4B in the single-stage continuous fermentation at controlled pH 5.5 over the experimental period.

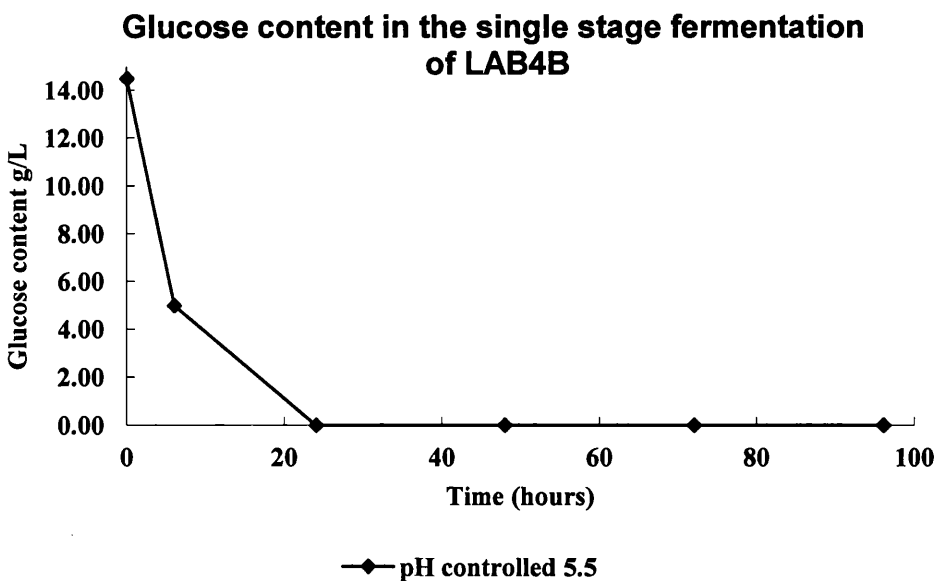

Figure 5.6: Glucose changes in the single-stage continuous fermentation with LAB4B at controlled pH 5.5 over the experimental period.

Results from administration of LAB4B on the 3 residential strains are presented in Figure 5.5. The results show that the amount of lactobacilli group (*L.salivarius* and *L.paracasei* CUL61&08) increased by about  $1.5 \log_{10} \text{ cfu ml}^{-1}$  during the treatment of LAB4B in the single-stage fermentation model at controlled pH 5.5. The bifidobacteria group (*B.lactis* and *B.bifidum* CUL34&20) maintained a similar viable count during the experimental period. The number of *E.coli* QC1 and *E.cloacae* QC4 increased sharply during the first 24 hours of batch incubation and start to drop after the probiotic administration. However, *E.coli* QC1 became relatively stable after 120 hours fermentation, *E.cloacae* QC4 dropped gradually from 9.0 to 5.9  $\log_{10} \text{ cfu ml}^{-1}$  during the experiment period (192 h). The number of *E.faecalis* QC9 slightly increased after the probiotic administration and it became stable 120 h after incubation which is similar to *E.coli* QC1.

In summary, the number of lactobacilli group, bifidobacteria group, *E.coli* QC1 and *E.faecalis* QC9 became relatively stable after 120 h in the single-stage fermentation at controlled pH 5.5 except that the number of *E.cloacae* QC4 gradually decreased between 24 to 192 hours fermentation. However, the number of all strains started to drop after 168 h which may relate to the limited glucose. Glucose content sharply



dropped from the initial concentration to zero after 24 hours (Figure 5.6). It shows that the glucose as the sole carbon source in the MMGM would be instantly used by co-cultures under the given flow rate (one turnover per day,  $10.4\text{mlh}^{-1}$ ) and that at this flow rate, the growth of the mixed population was substrate limited.

### 5.3.3 Single-stage continuous fermentation with LAB4

Similar results (Figure 5.7) were observed for the administration of LAB4. The results show that the amount of lactobacilli group (*L.acidophilus* CUL60&21) increased by about  $1.5 \log_{10} \text{cfu ml}^{-1}$  during treatment of LAB4 in the single-stage fermentation model at controlled pH 5.5. The number of bifidobacteria group (*B.lactis* and *B.bifidum* CUL34&20) also increased by about  $1.4 \log_{10} \text{cfu ml}^{-1}$  during the experimental period which was not shown in the LAB4B fermentation trial. It may be explained by the stronger growth competition of *L.salivarius* and *L.paracasei* CUL61&08 than *L.acidophilus* CUL60&21.

The growth pattern of *E.coli* QC1 and *E.cloacae* QC4 are similar to the trial described in Section 5.3.2. Both bacteria increased sharply during the first 24 hours batch incubation and started to drop after LAB4 probiotic administration. However, *E.coli* QC1 became relatively stable after 120 hours fermentation, and *E.cloacae* QC4 dropped gradually from  $8.40$  to  $5.99 \log_{10} \text{cfu ml}^{-1}$  during the experiment period (192h). The number of *E.faecalis* QC9 increased by about  $1.4 \log_{10} \text{cfu ml}^{-1}$  after the probiotic administration and became stable after 148 h incubation.

In summary, the number of lactobacilli group, bifidobacteria group, *E.coli* QC1 and *E.faecalis* QC9 became stable after 148 h in the single-stage fermentation at controlled pH 5.5 except that the number of *E.cloacae* QC4 gradually decreased during 192 hours fermentation. Glucose content sharply dropped from the initial content to zero after 48 hours compared with 24 h for LAB4B (Fig. 5.7).

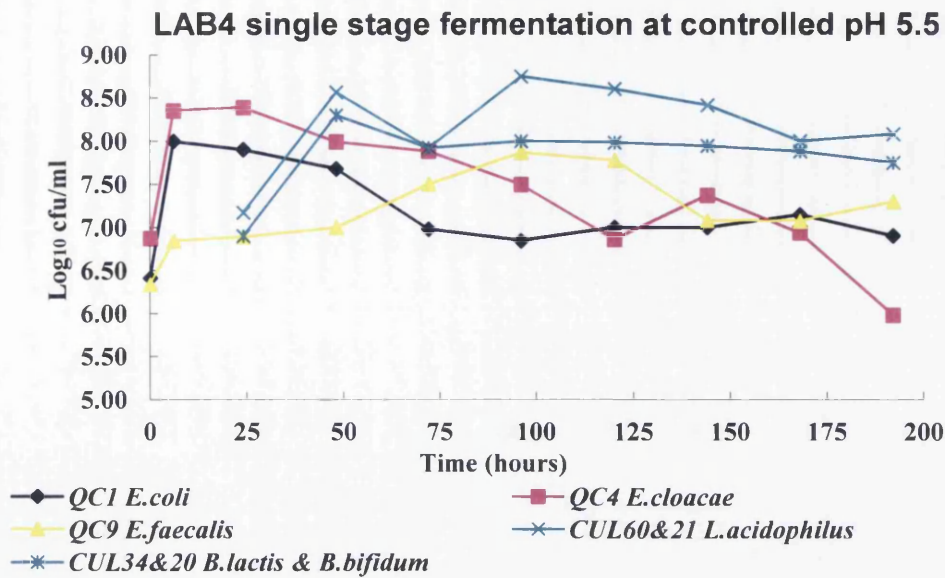

Figure 5.7: Growth of 3 mixture strains and LAB4 in the single-stage continuous fermentation at controlled pH 5.5 over the experiment period.

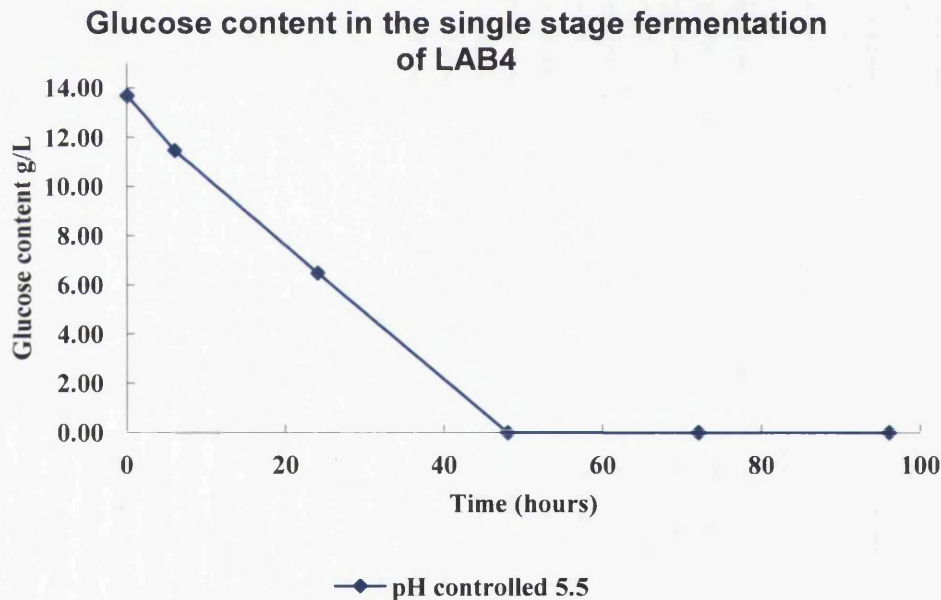

Figure 5.8: Glucose changes in the single-stage continuous fermentation with LAB4 at controlled pH 5.5 over the experiment period.

### 5.3.4 Results of screening the profile of probiotic strains

All colonies isolated from selective agar (see Table 5.1), were initially characterized from colonial appearance and gram stains (see Figure 5.9). Biochemical

identification reactions on API were also noted (see Section 5.3.4.2). In the work, randomly amplified polymorphic DNA-polymerase chain reaction (RAPD-PCR) was applied to the identification at species level of different probiotic strains from the co-cultures. RAPD-PCR analysis of the types of strains for different probiotic gave distinctive band profiles that allowed a clear differentiation of all the considered species (see Section 5.3.4.3).

#### 5.3.4.1 Gram stains of six probiotic strains

Gram stains have been checked from the single colony selected from the relative agar, they all matched the below images against six probiotic strains.

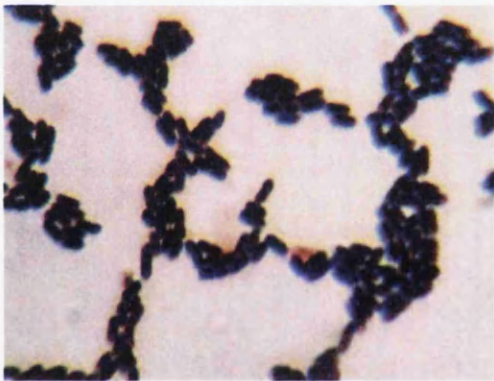

*Lactobacillus salivarius* CUL61

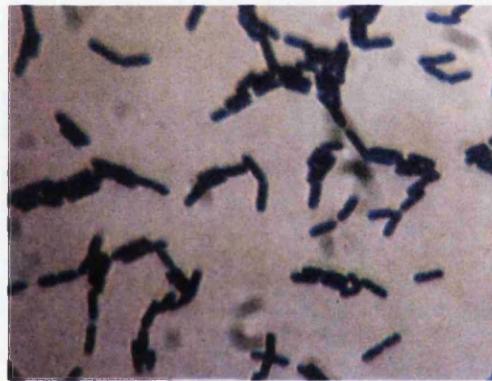

*Lactobacillus paracasei* CUL08

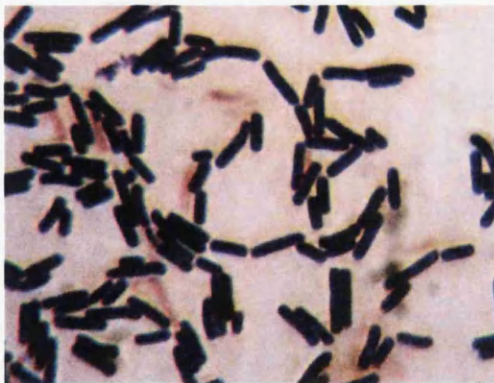

*Lactobacillus acidophilus* CUL60

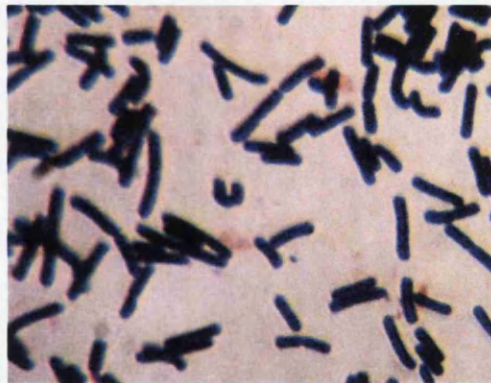

*Lactobacillus acidophilus* CUL21



*Bifidobacterium lactis* CUL34

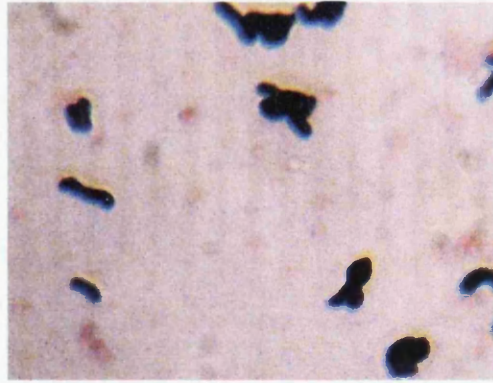

*Bifidobacterium bifidum* CUL20

Figure 5.9 Gram stains of typically isolated organisms of six probiotic strains (Source from Obsidian Research Ltd.).

#### 5.3.4.2 API test results

According to the test procedure described in Section 5.2.6.2, the result indicates that the percentage likelihood of 3 residential strains and probiotic strains respectively in the co-cultures are all over 99%.

#### 5.3.4.3 RAPD-PCR results

RAPD-PCR fingerprinting was carried out as described in Section 5.2.6.3. The RAPD fingerprint patterns for six isolated probiotic strains from the co-culture were confirmed against each standard strain profile (Figure 5.10).

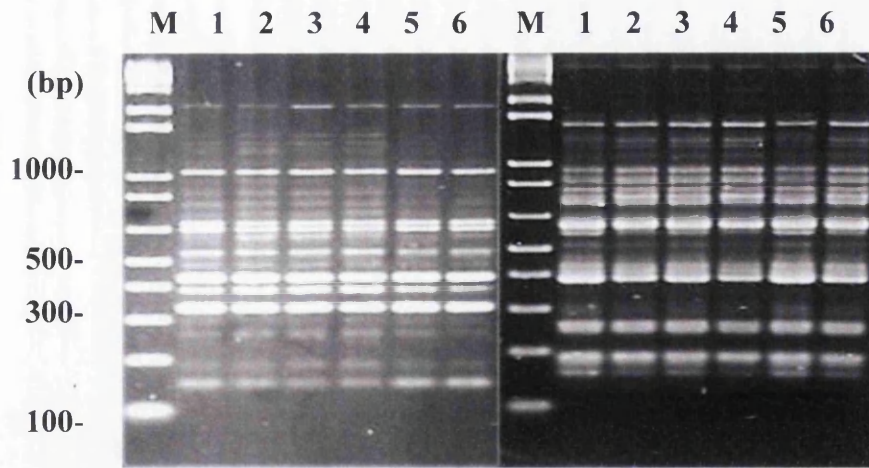

*Lactobacillus salivarius* CUL61    *Lactobacillus paracasei* CUL08

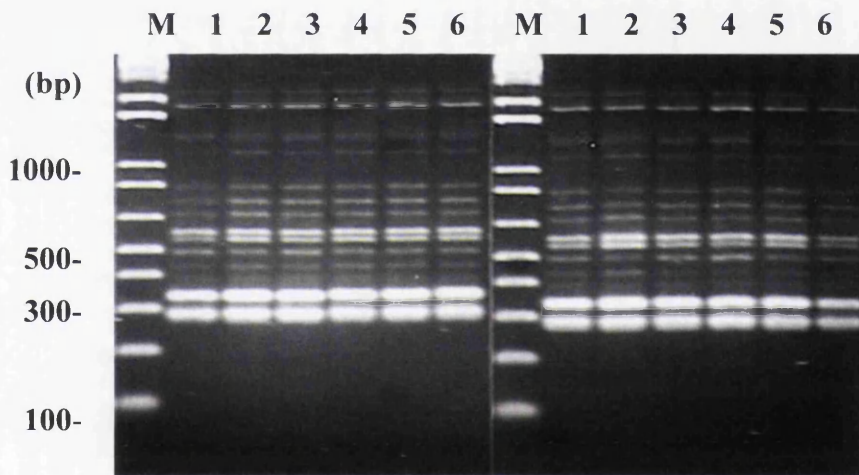

*Lactobacillus acidophilus* CUL60    *Lactobacillus acidophilus* CUL21

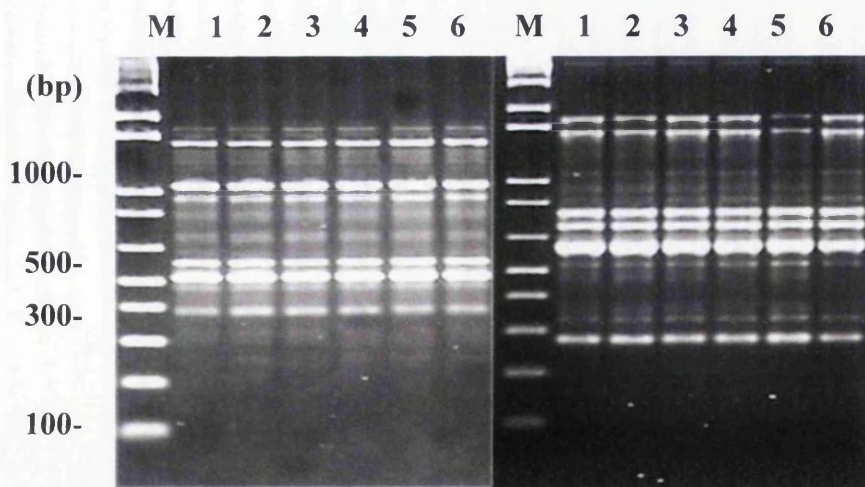

*Bifidobacterium lactis* CUL34      *Bifidobacterium bifidum* CUL20

Figure 5.10: RAPD-PCR fingerprint patterns of six probiotic strains against standard individual probiotic strains. Lane M is molecular size marker in bp. Lanes 1 and 2 are standard control of each probiotic strain and lanes 3-6 are the isolated strains from the co-culture.

### 5.3.5 Results of the two-stage continuous fermentation with LAB4B

Following the procedure of two-stage continuous flow fermentation trial (See Section 5.2.3), the whole system was run for 10 days (240 h) and 5 ml of fermentation culture was sampled daily. The bacterial population was enumerated by using standard selective media (see Table 5.1). The collected samples were centrifuged ( $5,000 \times g$ , 10 min) to remove the microbial cells. The glucose residue in the culture medium was measured by glucose test kits (See Section 5.2.7).

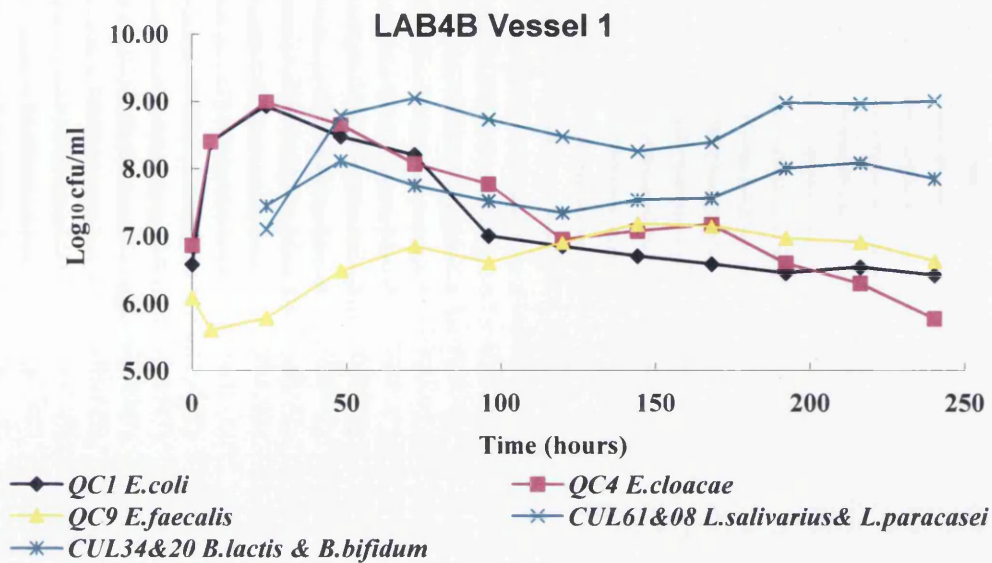

Figure 5.11: Growth of 3 mixture strains and LAB4B in vessel 1 at controlled pH 5.5 over the experiment period.

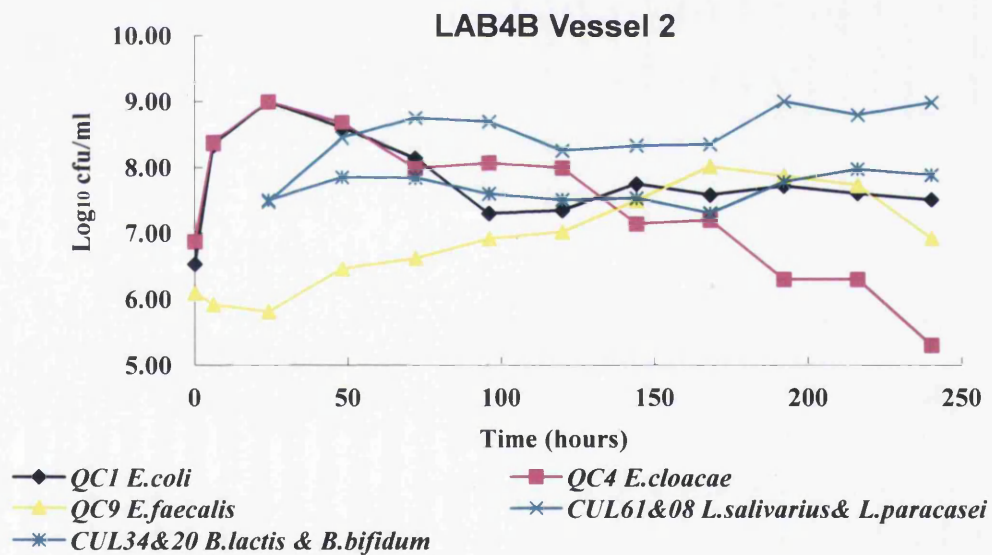

Figure 5.12: Growth of 3 mixture strains and LAB4B in vessel 2 at controlled pH 6.5 over the experiment period.

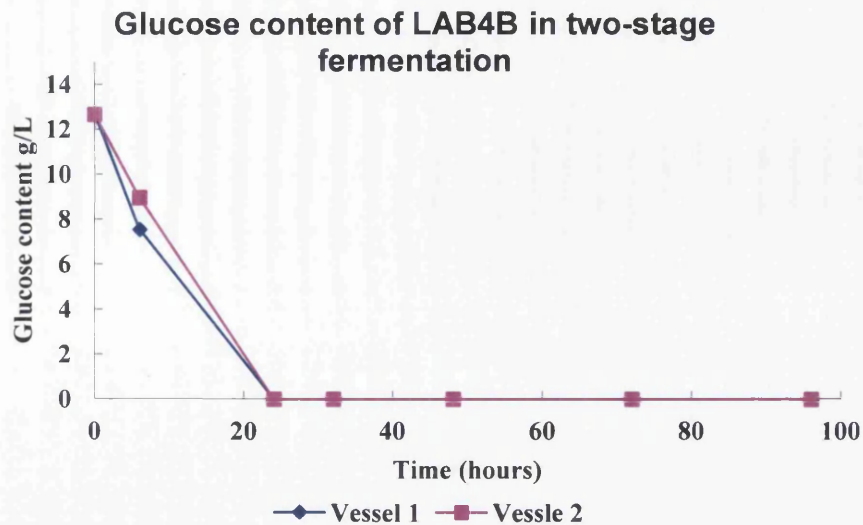

Figure 5.13: Glucose changes in the two-stage continuous fermentation with LAB4B over the experimental period.

Results of administration of LAB4B on the 3 residential strains in vessel 1 and vessel 2 are presented in Figure 5.11 and Figure 5.12. The results show that the amount of lactobacilli group (*L.salivarius* and *L.paracasei* CUL61&08) increased by about 1.7 and 1.5  $\log_{10}$  cfu  $\text{ml}^{-1}$  during the treatment of LAB4B in vessel 1 and vessel 2. The bifidobacteria group (*B.lactis* and *B.bifidum* CUL34&20) maintained a similar viable count during the experiment period in vessel 1 and vessel 2. The number of *E.coli* QC1 and *E.cloacae* QC4 increased sharply during the first 24 hours after batch incubation and started to drop after the probiotic administration in both vessels. However, *E.coli* QC1 became relatively stable after 144 hours of fermentation, *E.cloacae* QC4 dropped gradually from 9.0 to 5.78 or 5.3  $\log_{10}$  cfu  $\text{ml}^{-1}$  during the experiment period (240 h) in vessel 1 and vessel 2 respectively. The number of *E.faecalis* QC9 slightly increased after the probiotic administration and it became relative stable or slightly decreases 168 h after incubation in both vessels. Glucose content sharply dropped from the initial content to zero after 24 hours in the two vessels (Figure 5.13).

The main difference between vessel 1 and vessel 2 is that the viable count of *E.coli* QC1 after stabilization is higher in vessel 2 (7.6  $\log_{10}$  cfu  $\text{ml}^{-1}$ ) compared with vessel



1 ( $6.5 \log_{10} \text{ cfu ml}^{-1}$ ). A similar pattern has been found for *E. faecalis* that the viable count of *E. faecalis* QC9 after stabilization is higher in vessel 2 ( $7.4 \log_{10} \text{ cfu ml}^{-1}$ ) compared with vessel 1 ( $6.9 \log_{10} \text{ cfu ml}^{-1}$ ). This may indicate that both *E. coli* and *E. faecalis* like a neutral environment more than acidic conditions.

### 5.3.6 Results of the two-stage continuous flow fermentation with LAB4

Following the procedure of two-stage continuous flow fermentation trials (See Section 5.2.3), LAB4 was administered instead of LAB4B in the whole system. Changes in the mixture strains and glucose residue are given in Figure 5.14, Figure 5.15 and Figure 5.16.

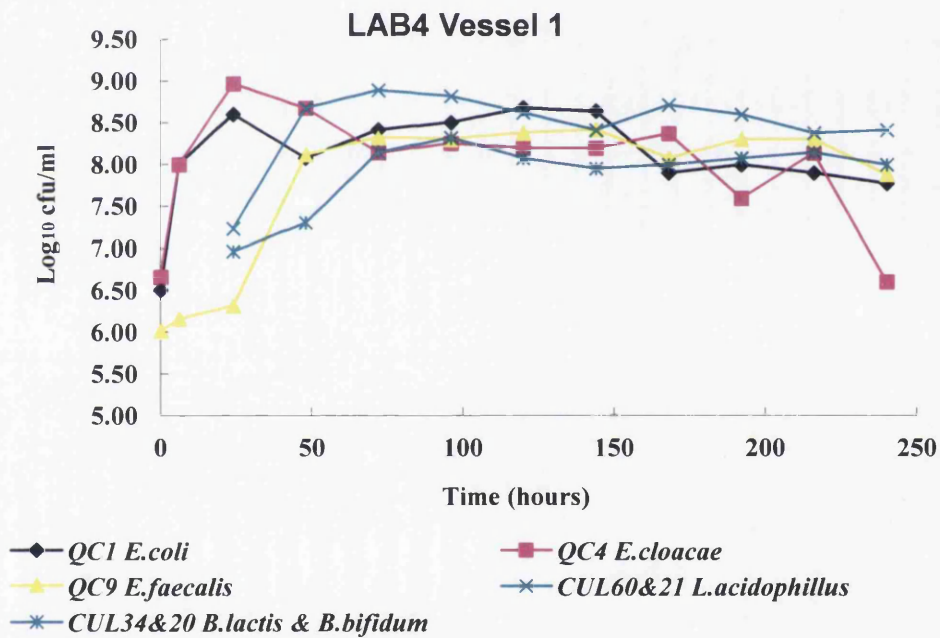

Figure 5.14: Growth of 3 mixture strains and LAB4 in vessel 1 at controlled pH 5.5 over the experiment period.

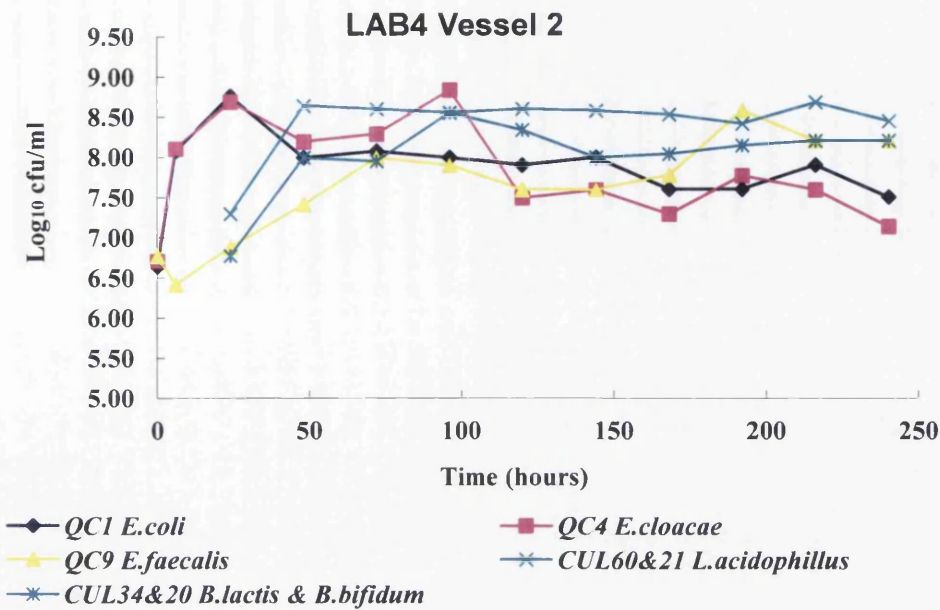

Figure 5.15: Growth of 3 mixture strains with LAB4 in vessel 2 at controlled pH 6.5 over the experiment period.

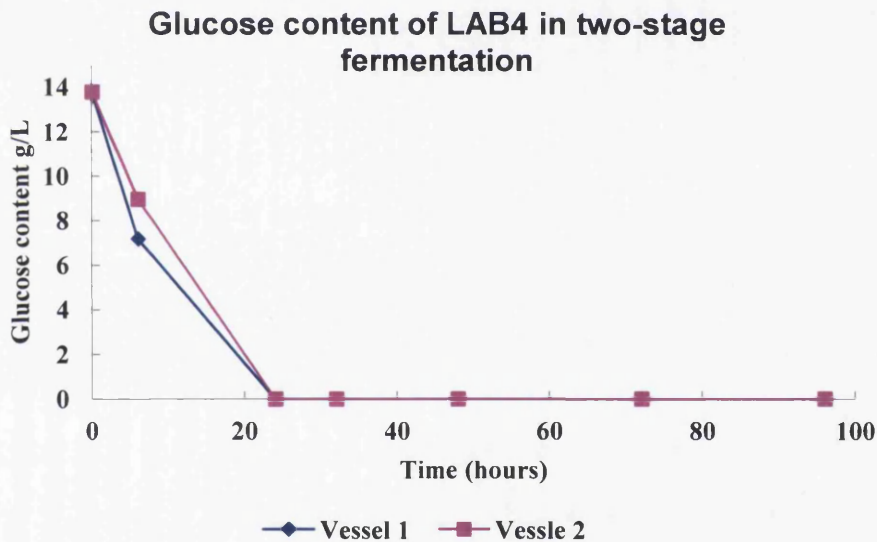

Figure 5.16: Glucose changes in the two-stage continuous fermentation with LAB4 over the experiment period.

As shown in Figure 5.14 and Figure 5.15, the amount of lactobacilli group (*L.acidophilus* CUL60&21) increased by about 1.5 and 1.2  $\log_{10}$  cfu ml<sup>-1</sup> during treatment of LAB4 in vessel 1 and vessel 2. The bifidobacteria group (*B.lactis* and *B.bifidum* CUL34&20) also increased by about 1.0 and 1.4  $\log_{10}$  cfu ml<sup>-1</sup> during the

experiment period in vessel 1 and vessel 2 which was not observed in the LAB4B continuous fermentation trial. The number of *E.coli* QC1 and *E.cloacae* QC4 increased sharply during the first 24 hours of batch incubation and started to drop after the probiotic administration in both two vessels. *E.coli* QC1 became relatively stable after 144 hours of fermentation, but *E.cloacae* QC4 dropped gradually from 8.97 or 8.70 to 6.60 or 7.15 log<sub>10</sub> cfu ml<sup>-1</sup> during the experiment period (240 h) in vessel 1 and vessel 2 respectively. The number of *E.faecalis* QC9 slightly increased after the probiotic administration and it became relatively stable 168 h after incubation in both two vessels. Glucose content sharply dropped from the initial content to zero after 24 hours in both two vessels (Figure 5.16).

It seems that there is no significant difference in the growth patterns of mixture strains in vessel 1 and vessel 2 after administration of LAB4. The viable count of bifidobacteria group (*B.lactis* and *B.bifidum* CUL34&20) is higher in the LAB4 fermentation trial (8.1 log<sub>10</sub> cfu ml<sup>-1</sup>) compared with the LAB4B fermentation trial (7.7 log<sub>10</sub> cfu ml<sup>-1</sup>). It may suggest that the co-culture of LAB4 will promote the bifidobacteria group growth in the *in vitro* continuous fermentation. However, further repeated experiments will be needed to give a reliable conclusion.

## 5.4 Discussions

The health beneficial effects of probiotics should be claimed on the individual and unique properties of each strain. Any claim of a probiotic product should be evidenced by well-designed, randomized double-blind clinical trials that confirm its health benefit to the host. More than often, clinical trials are not specific for screening purposes to compare various probiotic strains. An *in vitro* model may provide an alternative tool to gain knowledge of probiotics and their interactions on the intestinal microbiota. *In vitro* systems can simulate the *in vivo* conditions to a certain degree and have the major advantage that they can be easily set up and offer a reproducible way to investigate the specific perturbations on the intestinal microbial ecosystem (De Boever et al. (2000); Alander et al. (1999); Kontula et al. (1998);

Molly et al. (1996)). *In vitro* models simulating the physicochemical conditions of the human colon offer possibilities of studying the interactions of probiotic strains with indigenous colon microbiota, e.g. microbial compositions and metabolic activity (production of short chain fatty acid, gases, microbial enzymes, bacteriocins, etc.). The *in vitro* results have shown good correlation with results obtained in human volunteers' studies (Johansson et al. (1993); Marteau et al. (1993)).

The single-stage continuous fermentation model is a useful model for specific regions of the GI tract under physicochemical controlled conditions. It has several advantages that it is simple, easy to operate and economic of materials, but given the complexity of the large intestinal fermentation, it cannot reproduce the heterogeneity of physical conditions and nutrient availabilities that occur in different parts of the colon. Moreover, stability of the microbial community under long term studies is not always possible. An extension of the single-stage continuous flow chamber is the use of multiple stages which enables the simulation of different parts of the colon and allows long time study of the gut microbiota ecosystem. Multistage fermentation models are able to closely reproduce the associations of bacteria and have been used to investigate various microbial activities.

In this project, an *in vitro* fermentation model was designed and the entire fermentation apparatus was maintained inside a specially designed anaerobic workstation flooded with 80% N<sub>2</sub>, 10% CO<sub>2</sub> and 10% H<sub>2</sub>. It is a unique design to help to easily process, culture and examine samples without exposure to atmospheric oxygen. Thus, it allows the conduction of long-term dynamic fermentation trials in an atmosphere and conditions that are oxygen free. To the best of our knowledge, all other research groups used continuously O<sub>2</sub> free N<sub>2</sub> to flush each vessel and the growth medium reservoir to keep anaerobic environment. Based on the traditional approach, a few models have been recently developed to simulate the mucus-associated fermentation in the human colon, but a big disadvantage is that the whole system will lose the anaerobic environment after the sample e.g. mucin-covered microcosms are taken out from the fermentation vessel and the experiment must stop. This restricts

---

long-term dynamic fermentation. Our uniquely designed anaerobic workstation with a removable front panel and a sealed side chamber allow easy installation of large equipment and convenient sampling without damaging the anaerobic conditions, and this is an essential requirement in order to perform prolonged long-term fermentation study.

When experiments are designed to monitor the effect of a specific treatment on the composition of the *in vitro* microbial ecosystem, the reliability of the results strongly depends on the assumption of stability (Possemiers et al., 2004). It is crucial to start from a stable community which is more or less representative for the human microbiota ecosystem before investigating the effect of the specific treatment using the *in vitro* fermentation model. Some researchers used *in vitro* models to establish stabilization periods of 24h (Allison et al., 1989), 12 days (Possemiers et al., 2004), 14 days (Macfarlane et al., 1998), or 48 days (Gibson et al., 1988a), but a motivation for the choice of these periods is not apparent. In this present work, we used a single-stage and a two-stage continuous fermentation model to test the bacterial activities following supplementation of mix probiotic strains (LAB4 or LAB4B). The smaller operating volume (250 ml) and turnover rates (one turnover per day) were adapted from the three-stage model developed by Macfarlane et al. (1998). Temperature (37°C) and pH were automatically controlled. Culture pH in the vessels was set as 5.5 in vessel 1, representing the low pH environment of the ascending colon and 6.5 in vessel 2, indicative of a more neutral pH in the descending colon. In order to get the stabilization environment using 3 residential strains in the *in vitro* model, the batch culture fermentation was run for at least 24 h to establish steady stage conditions before the medium pump was started. We tested the stability of microbiota composition and survivability of probiotic in these models to give basic information to further study the effects between probiotic and intestinal microbiota in future research.

Our experiments demonstrate the interaction with the residential microbiota (3 residential strains) and show that the addition of probiotic did not affect significantly

---

the total number of bacteria growing in the continuous culture. The amount of lactobacilli group (*L.salivarius* and *L.paracasei* CUL61&08 or *L.acidophilus* CUL60&21) increased by about 1.2-1.7 log<sub>10</sub> cfu ml<sup>-1</sup> and both remained at high levels throughout the 10 days of sampling either in the single-stage or in the two-stage continuous fermentation model. The bifidobacteria group (*B.lactis* and *B.bifidum* CUL34&20) also increased by about 1.0 and 1.4 log<sub>10</sub> cfu ml<sup>-1</sup> during the administration of LAB4 which was not evident in the LAB4B in either single-stage and two-stage continuous fermentation models. It may be explained by the stronger growth competition of *L.salivarius* and *L.paracasei* CUL61&08 than *L.acidophilus* CUL60&21. It may suggest that the co-culture of LAB4 will promote the *bifidobacteria* group growth in the *in vitro* continuous fermentation. However, further repeated experiments are needed to make a firm conclusion. Relative numbers of *E.cloacae* QC4 gradually decreased from day 1 to day 10 in the two-stage continuous fermentation model. All the other strains including *E.coli* QC1, *E.faecalis* QC9, lactobacilli group and bifidobacteria group remained stable from day 5 to day 10. Similar results have been obtained in a few other studies. Changes in the GI microbiota of human volunteers on oral supplementation of lactobacilli were shown to be small (Orrhage et al., 1995). Alander et al. (1999) demonstrated a maximum increase in lactic acid bacteria of about log<sub>10</sub> cycles after administration of five probiotic strains separately in the SHIME model. The same author (Alander et al., 1999) also found that the amount of enterobacteriaceae decreased during LAB treatment in the SHIME model.

However, the results of this work gave only a relative approximate picture of the effects of probiotic treatment on the microbial population. The assessment of any individual strain would need more repeated experiments and also the results obtained here with all their limitations such as the specific effects of individual strains should be discussed. The present model with 3 residential strains in this work is perhaps over simplified for representing the complex microbial community in the human colon. Most works can be done by using faecal slurry inoculated into the vessel to

represent the stable microbial community compositions, but even this cannot fully represent the microbial ecosystem in the colon.

## 5.5 Conclusion

A reliable and flexible anaerobic multistage continuous fermentation platform has been developed, and it can facilitate various *in vitro* anaerobic fermentation experiments to investigate the human gut microbial ecosystem. Using this new system, a series of general testing has been performed to study the interaction of commercial probiotics and typical microorganisms found in the human GI tract. The experimental observation and measurement are consistent with the literature results, which further confirms the feasibility and effectiveness of the new system. Some of these experimental findings are also meaningful in guiding the production and use of probiotics. In conclusion, the specially designed *in vitro* continuous fermentation model in the anaerobic workstation provides a reliable and relatively inexpensive tool for simulating the microbiota ecosystem and investigating the metabolic activities under different nutritional and environmental conditions. The system has fully met the design requirement. It is also noted that to make more informative conclusion on human gut microbiota, more complex microbiota should be employed to more closely simulate the *in vivo* environment of the human gut. However, the purposely built *in vitro* platform has generated a good set of first-hand data for the development of mathematical models of the human GI tract.

# Chapter 6 *In Vivo* Study of Gut Microbiota of Infants Based on DNA Sequencing

## Abstract

This Chapter describes the use of a new sequencing technology (454-pyrosequencing) to assess the gut microbiota profiles in healthy infants selected from the randomized, double-blinded, placebo-controlled clinical trial conducted by Swansea University and Cultech Ltd. Due to the high cost of 454-pyrosequencing analysis, the analysis of microbiota profiles is limited to 50 faecal samples from 9 healthy infants who were taking either probiotic or placebo during the first 6 months after birth. The DNA-sequencing data provide representative and comprehensive profiles of gut microbiota in healthy infants. The data also provide evidences for possible analysis of more neonatal samples obtained from the infants in the birth cohort who had high risk of atopy in the Swansea clinical trial. The analysis shows that probiotic did alter the composition of the gut microbiota compared with those in the placebo group and, hence, the administration of probiotics to healthy infants may be an effective way to impact on gut colonization with healthy bacteria. It should be noted that these initial conclusions are based on the analysis of a relatively small number of samples.



## 6.1 Introduction

### 6.1.1 Background for gut microbiota of infants

Throughout the human lifetime, the healthy intestinal microbiota profile performs vital functions, such as protection against pathogens, metabolic reactions, trophic effects, and maturation of the immune system. The neonatal period is crucial for colonization of the intestinal microbiota. Within days, a rich and dynamic ecosystem develops from a sterile environment when the baby is born and the microbial population soon outnumbers the baby's own cells. The interactions between the host and its microbiota are important for human health and these interactions can have beneficial nutritional, immunological and developmental effects, or pathogenic effects for the host (Penders et al. (2006); MacDonald et al. (2005a, 2005b); Backhed et al. (2004)). The infant's gut microbiota is highly dynamic in the first year of life but the microbial diversity is low, and the microbial population starts to stabilize and resemble that of the adult after two years old (Marques et al., 2010). There is a big difference of the gut microbiota between infants and adults and also the infant's intestinal microbiota shows very significant inter-individual variability. Until now, it is still difficult to define a universal standard for intestinal microbiota composition and clarify how this is related to health and disease.

It is widely accepted that facultative anaerobic bacteria (e.g. *Staphylococcus*, *Streptococcus*, *Enterococcus* and *Enterobacteriaceae* spp.) are the early colonizers in the infant's gut within the first days of life. When these first colonizers consume oxygen and reduce the initial high redox potential, the gut favours the obligate anaerobes such as *Bifidobacterium*, *Clostridium*, *Bacteroides*, and sometimes *Ruminococcus* (Matamoros et al., 2013). *Bifidobacterium* is recognized as the residential bacterium in the neonatal GI tract (Harmsen et al. (2000); Turrone et al. (2012)), while other reports found it occurred in only a small fraction of infants (Hopkins et al., 2005). The neonatal colonization pattern can be influenced by a broad range of factors including mode of delivery (vaginal delivery or caesarean

section), type of feeding (exclusive breast-fed versus formula-fed), gestational time, the use of antibiotic, infant hospitalisation, surrounding environment and maternal infection (Marques et al., 2010). Figure 6.1 shows the factors affecting the infant gut composition (Matamoros et al., 2013).

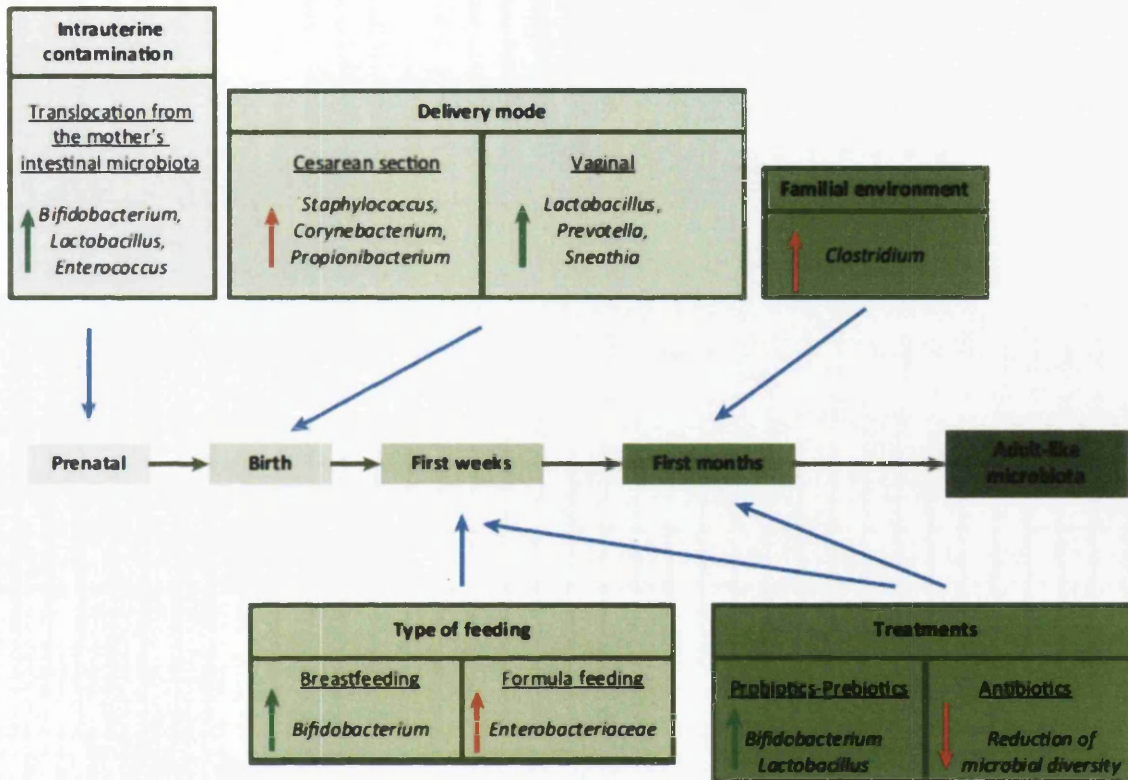

Figure 6.1: Effect of external factors on the intestinal microbiota of infants. (Green arrows show positive modification and red arrows show negative modification for human health).

Gestation time is a strong factor that influences the establishment of the infant intestinal microbiota. The composition of gut microbiota differ significantly between full-term and preterm neonates. Preterm infants show higher levels of *Enterobacteriaceae* and other potentially pathogenic bacteria such as *E.coli*, *Flebsiella* spp. and *Clostridium difficile* (Arboleya et al., 2012a). However, the diversity of the microbiota in full-term infants is much higher and it favours some common genera such as *Bifidobacterium*, *Lactobacillus* and *Streptococcus* (Arboleya et al., 2012b). In addition, preterm infants are often cared for in the neonatal

intensive care units and receive broad spectrum antibiotics which further delay the establishment of beneficial bacteria (Prescott et al., 2008).

Mode of delivery is believed to have the most significant influences on early gut colonization (Biasucci et al., 2010). The meconium of neonates analysed by pyrosequencing shows that the microbial communities are strongly related to the mother's vaginal delivery (e.g. *Lactobacillus*, *Prevotella*, or *Sneathia*) or caesarean section (*Staphylococcus*, *Corynebacterium*, and *Propionibacterium*) (Dominguez-Bello et al., 2010). These pioneer bacteria usually originate from the vagina or the skin depending on the mode of delivery. *Bifidobacterium* in caesarean section babies are much lower than in vaginal delivered babies, and also the diversity of the microbiota in the former appears to be lower (Biasucci et al., 2008). However, there seems to be less influence of mode of delivery on the gut colonization in preterm infants (Arboleya et al., 2012a).

Apart from the delivery mode, type of feeding (exclusively breast-fed versus formula-fed) also shows strong influence in the development of the infant intestinal microbiota. Full term vaginally delivered, breast-fed neonates show higher counts of bifidobacteria and lactobacillus. They are frequently detected in the early life, suggesting that breast milk is an important delivery system for probiotic bacteria (Fernandez et al., 2013). *Streptococcus* and *Staphylococcus* genus are also present as early colonizers in the gut (Collado et al. (2009); Sahl et al. (2012)). However, formula-fed neonates harbour more diverse microbiota such as *Bacteriodes*, *Clostridium coccoides* group, *Staphylococcus*, and *Enterobacterium* (Fallani et al. (2010); Rinne et al. (2005)).

### **6.12 Effects of probiotics on neonatal gut microbiota**

Colonization of the neonatal intestine plays a key role in the development of the immune responses, maturation and function (Round et al, 2010). A few studies showed the important association between the neonatal gut microbiota and host mucosal and systemic immunity during the first year of life (Martino et al. (2008);

---

Sjogren et al. (2009)). The rapid increase in immune-related disorders such as eczema, allergic rhinitis and inflammatory bowel disease (IBD) in the past decades is hypothesized to be related to microbial disruption in early life (Wang et al. (2008); Sjogren et al. (2009); Garn et al. (2007)). Some studies reported the differences in neonatal gut microbiota in relation to development of allergic disease (Sjogren et al. (2009); Penders et al. (2007); Bjorksten et al. (2001); Kalliomaki et al. (2001)). For example, reduced gut microbiota diversity during infancy has been strongly associated with atopic eczema in later life (Bisgaard et al. (2011); Abrahamsson et al. (2012)). The intestinal microbiota diversity of neonates suffering from atopic eczema during the first 18 months was much lower in comparison to healthy neonates (Penders et al., 2007). Found in these studies, the general characters of gut microbiota of those infants later developing allergy are a reduced diversity, lower counts of bifidobacteria and lactobacilli and early *Staphylococcus aureus* and *Clostridium difficile* colonization.

As neonatal gut microbiota is more variable in its composition and less stable over time compared to the adult, the administration of probiotic during the prenatal and postnatal period in order to shape neonatal gut colonization with potentially beneficial bacteria may be a good opportunity to impact on future health problems (Cerf-Bensussan et al. (2010); Yolanda (2011)). Intentional modulation of microbiota composition through use of probiotic and prebiotic have been confirmed to stimulate the growth of *bifidobacteria* and help in the treatment and prevention of certain illnesses (Storro et al. (2010); Oien et al. (2008)).

Some recent studies reported evidence for the modulation of neonate gut microbiota by consumption of probiotics and prebiotics. Consumption of *Lactobacillus* GG by Finnish mothers before delivery and during breastfeeding increased the diversity of the *Bifidobacterium* species (Gueimonde et al., 2006). A double-blind placebo-controlled trial in Finland and Germany on the impact of probiotic intervention showed higher lactobacilli and enterococci counts in probiotic groups compared with placebo groups (Grzeskowiak et al., 2012). Administration of

*Lactobacillus rhamnosus* GG (ATCC 53103) in a total of 132 Finnish neonates during the first 6 months were followed for 2 years after treatment. The results showed a good tolerance and less lactobacilli / enterococci and clostridia in the faecal microbiota after two years (Rinne et al., 2006). Ninety premature neonates treated with bifidobacteria enriched formula had higher bifidobacteria content in the infants' stool than the placebo group, but no differences were noted for the colonization of lactobacilli or staphylococci (Underwood et al., 2009). Full term infants who had been bottle-fed with formula containing prebiotic (galacto- and long-chain fructooligosaccharides) exhibited a good tolerance and higher stool frequency, and also there was a trend to suppress the numbers of *clostridia* and *E.coli* and slightly increase stool bifidobacteria (Costalos et al., 2008).

Prenatal probiotic administration (*Lactobacillus rhamnosus* GG) to mothers during late pregnancy can increase faecal *Bifidobacterium longum* in infants at high risk of allergy (Lahtinen et al., 2009). A large cohort study of the correlation between mode of delivery and the risk of asthma and atopy from Holland showed that the colonization of *Clostridium difficile* in caesarean delivered children increased the risk of asthma and eczema throughout the first 6 or 7 years of life (van Nimwegen et al., 2011). Lower amount of bifidobacteria were found in breast-milk in allergic mothers compared with healthy mothers, and their infants also had lower levels of bifidobacteria in the faeces (Gronlund et al., 2007). Reduced numbers of bifidobacteria and increased numbers of *Staphylococcus aureus* have been detected in neonates who later on became obese compared with healthy children (Kalliomaki et al., 2008). A recent study showed that the proportion of bifidobacteria counts was inversely associated with daily amounts of crying in infants (Partty et al., 2012).

Neonates and their mothers seems have a good tolerance of the administration of probiotic and prebiotic. There are lots of beneficial effects for neonates by feeding probiotic and prebiotic including enteric inflammatory conditions, acute diarrhoea, necrotizing enterocolitis, asthma, atopic dermatitis and eczema (Brenchley et al. (2012); Rautava et al. (2012); Braegger et al. (2011); Marques et al. (2010)).

### 6.1.3 Motivation and objectives of the present *in vivo* study

Supported by the Knowledge Exploitation Fund, Collaborative Industrial Research (project no. HE 09 COL 1002), Welsh Assembly Government and Cultech Ltd. in 2005, a randomized, double-blinded, placebo-controlled clinical trial was undertaken by Swansea University to evaluate administration of probiotic organisms in the prevention of atopy in infants and children. This study was approved by the Swansea Local Research Ethics Committee in 2004 (International Standard Randomized Controlled Trial, ISRCTN 26287422). From a total of 1419 pregnant women attending antenatal clinics who were eligible to join this study in the Singleton Hospital, Swansea, 454 women were recruited. Among these, 413 (91%) women were carrying foetus at high risk of atopy, defined as foetus with a first-degree relative with either asthma or eczema; 41 (9%) women from non-atopic families were also recruited. The study allocated 220 women to the treatment group and 234 to the placebo group. A mixture of 4 live probiotic strains (LAB4B: *Lactobacillus salivarius*, *Lactobacillus paracasei*, *Bifidobacterium animalis subsp lactis* and *Bifidobacterium bifidum* provided by Cultech Ltd.) was administered to mothers during the last month of pregnancy and to infants during the first 6 months of life.

The main objectives of the above project were: 1) To determine the effect of probiotic administration on eczema in children aged 0-2 years and asthma in children aged 0-5 years; 2) To determine the effect of probiotic administration on changes in key immunological parameters associated with atopy; 3) To identify any adverse effects (AE) in a potentially vulnerable population; 4) To determine microbiota composition in infant stools after birth, 2 and 6 weeks and also at 4 weeks after supplementation of the probiotic / placebo ceases at 6 months. All microbial analysis was completed using culture-based methods. The findings of this project supported the safe use of LAB4B probiotic strains during pregnancy and early infancy (Allen et al., 2010).

The present research focuses on determining the gut microbiota profiles in healthy neonates with probiotic administration, in the hope of discovering the development

---

pattern of gut microbiota in early life. As the first continuing research to make use of the large collection of samples obtained from the previous clinical trials, the present research will also provide a detailed reference and a solid foundation for later studies to investigate the correlation between faecal microbiota composition and the prevalence of allergic diseases in late infancy after administration of probiotics. This research selects infants from non-atopic families that have participated in the previous *in vivo* trial at the Singleton Hospital, Swansea. The microbiota profile of each individual is analyzed using 454-pyrosequencing technology to give a nearly comprehensive coverage of known species. Section 6.1.4 gives a brief overview of all major methods that have been used for the analysis of gut microbiota.

#### **6.1.4 Analysis methods for gut microbiota**

In the past, the infant gut microbiota composition was investigated using culture-based methods. The lack of knowledge of the special nutrient requirements for the majority of microorganisms could result in up to 90% of bacteria escaping culture detection with traditional techniques (O'Toole et al., 2010). Selection of correct media (e.g. biochemical selective agents such as bile, esculin or antibiotics), temperature control, and time of the growth are critical to cultivate a large portion of the GI bacterial community (Fouhy et al. (2012b); O'Sullivan et al. (2000)). These approaches are still being employed in some studies for phenotypic and genotypic characteristics of specific strains and for developing novel probiotics (Jost et al. (2012); Hascoet et al. (2011)). Despite advances in culturing capabilities, these approaches have largely been replaced by culture-independent DNA-based approaches for characterizing complex microbial environments such as the human gut. Table 6.1 compares techniques used to investigate the human gut microbiota (Fouhy et al., 2012b).

Molecular tools such as denaturing and temperature gradient gel electrophoresis (DGGE and TGGE, respectively) have been applied in microbial ecology (Cani et al., 2008). This analysis works by the separation of amplicons (e.g.16S ribosomal RNA gene (16S rRNA)) based on their GC content to distinguish the band pattern of

---

the specific composition of microbial populations. As 16S rRNA is present in all prokaryotes which contains conserved and variable regions, the amplicon generation and differentiation can be facilitated by band excision and sequencing (O'Toole et al., 2010). Terminal restriction fragment length polymorphism (T-RFLP) is another popular molecular approach which uses a set of fluorescently labelled primers in a PCR reaction to amplify 16S rRNA from different microbial communities (Engelbrekton et al., 2006). It is an effective method to determine a lactobacilli community based on lactobacilli 16S rDNA polymorphism (Davis et al. (2010); Coolen et al. (2005)). Quantitative Real-Time Polymerase Chain Reaction (qPCR) is the most recent popular molecular biological tool used to amplify and simultaneously quantify specific bacterial taxa present in a bacterial community. A benefit of qPCR over other technologies is the ability of both detection and quantification. qPCR using species-specific primers to quantify lactobacilli and bifidobacteria in the human GI tract have been investigated in some studies (Lambert et al. (2013); Prasad et al. (2013); Bervoets et al. (2013)).

Fluorescence in situ hybridization (FISH) uses DNA-basis but is not based on PCR approach. It is a probe-based method to focus on specific populations rather than the whole microbiota community. FISH uses a fluorescently-tagged probe which can be bound by the bacteria and detected using fluorescent microscopy. Lactobacilli and bifidobacteria can also be determined by FISH using specific designed oligonucleotide probes and primers (Machado et al. (2013); Kerckhoffs et al. (2009)). Phylogenetic microarrays are the next step culture-independent technologies. They allow hybridization of greater numbers of sequences (fluorescently labelled) attached to one glass slide and their expression can be measured using a fluorescence assay. Microarray is also a popular tool for infant gut microbiota analysis including lactobacilli and bifidobacteria (Nylund et al. (2013); Manuela et al. (2013); Turrone et al. (2012)).



Table 6.1: Techniques to investigate the human gut microbiota (Fouhy et al, 2012b)

	<b>Microflora associated characteristics</b>	<b>Culture dependent techniques</b>	<b>Culture independent techniques</b>	<b>High through-put sequencing</b>
<b>Technique description</b>	The use of characteristics associated with microbes e.g., SCFA production to identify if differences exist in the gut microbial populations between different subject groups.	Use of selective media to culture specific microorganisms e.g., Man Rogosa Sharpe (MRS) media for lactobacilli growth.	Identify bacteria through isolation and amplification of bacterial DNA e.g., 16S rRNA gene. Includes: PCR, DGGE, TGGE, T-RFLP, qPCR, dot blot hybridization, FISH, flow cytometry	Sequencing based approaches used to rapidly identify bacteria using bacterial DNA as template e.g., 454, Illumina, SoLID, Ion torrent.
<b>History of use</b>	To date has been predominantly used as an initial population screen or in epidemiological studies.	Historically, the most frequently used approach to identify bacteria present in various environments.	Increasingly popular in past two decades with increasing availability of computer based technologies and software programs	Became commercially available at the beginning of the 21 <sup>st</sup> century and becoming increasingly popular ever since.
<b>Advantages</b>	Simple; Inexpensive; Suitable as an initial screen to test a novel hypothesis; Useful for large population screens e.g., in epidemiology studies.	Quick; Inexpensive; Limited skill required; Limited equipment needed; Useful as the initial screen before more detailed investigated.	Relatively inexpensive; Relatively simple; More detailed results achievable.	Less biased results; Very detailed information; Bacterial profile in complex environments e.g., gut microbiota can be identified; Huge phylogenetic information provided; Relatively quick
<b>Disadvantages</b>	Provides limited information; No bacterial species Identification possible.	Up to 90% of bacteria non-culturable; Provides limited information; Need prior	Prone to PCR bias; Requires more sophisticated equipment and training on their use; May need	Extremely expensive; Data handling requirements are significant; Requires training

		knowledge of bacteria to screen for; Requires further tests for species identification.	several methods in combination to get appropriate level of details in results.	on sample preparation and machine use and experience of interpreting results.
Examples of studies efficiently using this technique	Goodman et al., 2011 Tjellstrom et al., 2007 Cardona et al., 2002 Bottcher et al., 2000	Hascoet et al., 2011 Bennet et al., 2002	Nylund et al., 2013 Jost et al., 2012 Fallani et al., 2011	Fouhy et al., 2012a De Filippo et al., 2010 Vaishampayan et al., 2010 Dominguez-Bello et al., 2010 Wu et al., 2010 Roesch et al., 2009
Future use in infant gut microbiota research	Most likely to be used to test novel hypotheses and to be followed up with more detailed techniques.	Likely to become infrequently used and to be mainly used in combination with and verified by newer technologies.	Likely to remain popular in the coming decade, but decrease thereafter as increased availability and use of sequencing approaches occurs.	Increased use since the year 2000 as cost is decreasing and likely to become the main approach used in the future

As highlighted by an extensive review in 2008, the focus of today has shifted to ‘metagenomic era’ which employs DNA sequencing-based techniques to investigate the GI microbiota (Frank et al., 2008). Large scale DNA sequencing (high-throughput sequencing) provides detailed information for the whole microbial population which contrasts with targeted approaches (FISH, qPCR and microarray) (Mardis et al., 2008). High-throughput sequencing technologies such as Roche 454 pyrosequencing, Illumina and SOLiD (Sequencing by Oligonucleotide Ligation and Detection), SMRT (Pacific Biosystems), and nano-pore sequencers technology generate millions of short sequence reads per run, allowing characterization of an entire complex microbial community and comparisons of microbial composition at different phylogenetic levels (Roos et al. (2013); Fouhy et al. (2012b); Clarke et al. (2009); Strausberg et al. (2008); Mardis (2008); Shendure et al. (2005)).

These 'next generation sequencing' (NGS) technologies have already been employed to reveal the role of the GI microbiome in diverse diseases such as Crohn disease (Gophna et al., 2006), irritable bowel syndrome (Kassinen et al., 2007), colonic cancer (Zhu et al., 2011), obesity (Ley (2010); Turnbaugh et al. (2006)), atopic disease (Hong et al. (2010); Forno et al. (2008)), necrotizing enterocolitis (Mshvildadze et al., 2010), the effects of diet (De Filippo et al. (2010); Turnbaugh et al. (2009b)) and antibiotics use (Dethlefsen et al., 2008) on the gut microbiota.

## 6.2 Materials and methods

### 6.2.1 Neonate faecal samples

In the original clinical trial recapped in Section 6.1.3, women during the last month of pregnancy and their infants from birth to six months received daily vegetarian capsules containing either 100 mg of LAB4B probiotic strains or identical placebo capsules containing maltodextrin. The 100 mg LAB4B capsule consists of *Lactobacillus salivarius* CUL61 (NCIMB 30211)  $6.25 \times 10^9$  colony-forming units (cfu), *Lactobacillus paracasei* CUL08 (NCIMB 30154)  $1.25 \times 10^9$  cfu, *Bifidobacterium animalis subsp lactis* CUL34 (NCIMB 30172)  $1.25 \times 10^9$  cfu, and *Bifidobacterium bifidum* CUL20 (NCIMB 30153)  $1.25 \times 10^9$  cfu (Provided by Cultech Ltd., UK). For mothers, the daily dose was one capsule (100 mg powder) taken by mouth or by sprinkling the contents of the capsule onto food. For infants, the preparations were administered either directly into the baby's mouth or mixed with formula or expressed breast milk.

Infant stool samples were collected according to a prescribed schedule, beginning with the first stool produced after birth, then every two weeks with a decreasing frequency over the six months period, and finally a further four weeks after the probiotic supplementation ceased at the end of 6 months. Fresh faeces in nappies were placed into an anaerobic plastic bag and refrigerated until they were transported to the laboratory. All samples were stored at  $-80\text{ }^{\circ}\text{C}$  until further processing.

Table 6.2: Characteristics of the participants in this study

Subject ID	Gender	Intervention group <sup>1</sup>	Mode of delivery	of Breast-feeding	Antibiotic Use	Samples Analyzed (Collection Week) <sup>4</sup>
16	M	A	Vaginal	None	None	8 13 19
25	F	A	Caesarean	Yes (5w) <sup>2</sup>	None	3 7 12 18 25 28
57	F	A	Vaginal	None	4 Days <sup>3</sup>	7 13
76	M	A	Vaginal	Yes (3w)	None	0 18 28
133	M	B	Caesarean	None	None	0 6 12 18 24 25 27 29 32
160	M	B	Vaginal	Yes (5w)	None	0 2 7 12 20 25
189	M	A	Caesarean	None	7 Days	4 7 17 19 25 26 28 28 29
219	F	A	Caesarean	None	None	0 3 7 15 24 25 27 27 29
256	M	A	Caesarean	Yes (5w)	None	2 9 13

<sup>1</sup>: A group received probiotic daily and B group received placebo daily.

<sup>2</sup>: Breast feeding for the first 5 weeks.

<sup>3</sup>: Taking antibiotic for 4 days in the first 6 weeks.

<sup>4</sup>: All the participants stopped to take probiotics / placebo after 24 weeks.

Due to the high cost of 454-pyrosequencing analysis, the present research selected 9 healthy and full term babies (total 50 sample collecting points) born between September 2005 and June 2006 at Singleton Hospital, Swansea to provide representative and comprehensive microbiota profiles according to mode of delivery, infant diet, and administration of probiotic / placebo. Informed consent was obtained from the parents of each infant. Characteristics of the participants in this study are summarized in Table 6.2.

### **6.2.2 Bacterial DNA extraction from faeces**

The bacterial DNA was extracted and purified by the QIAamp DNA Stool Mini Kit (Cat. No. 51504, Qiagen, West Sussex, UK) in combination with additional bead beating step using a FastPrep<sup>®</sup>-24 System (MP Biomedicals, Solon, OH 44139, USA). Briefly, 180-220 mg (wet weight) of stool was weighed into a 2 ml Lysing Matrix B Tube (MP Bio) containing 0.1 mm silica beads (BioSpec). Then, 1.4 ml buffer ASL was added to the tube and shaken with the Fastprep<sup>®</sup>-24 for 3×60 s with 5 min rest in between. The sample was then incubated at 70°C for 5 minutes. After centrifugation at full speed for 1 minute, 1.2 ml of supernatant was collected into a 2 ml tube and the sample was mixed and treated with one Inhibit EX<sup>®</sup> tablet to remove the DNA-damaging substances and PCR inhibitors. After vortex mixing for 3 minutes, the suspension was incubated at room temperature for 1 minute. After 3 minutes of centrifuge at full speed, all supernatant was pipetted into a new 1.5 ml tube and centrifuged at full speed for 3 minutes. Next, 200 µl of supernatant was treated with 15 µl proteinase K, 200 µl buffer AL, and incubated at 70°C for 10 minutes. After precipitation with 200 µl ethanol, the supernatant was collected after centrifuging. DNA in the sample was further purified on a QIAamp spin column and eluted in 200 µL of AE-buffer and stored at -20°C according to the manufacturer's instruction.

### 6.2.3 454-pyrosequencing analysis

Genomic DNA isolated directly from frozen baby faecal samples (Section 6.2.2) was analyzed using 454-pyrosequencing technique by the Research and Testing Laboratory (RTL, Lubbock, TX, USA). Bacterial tag-encoded FLX amplicon pyrosequencing (bTEFAP) was used to determine the relative percentages of the primary populations of organisms in the baby faecal samples.

This technique is a semi-quantitative universal detection and identification method for bacteria based upon the Roche Titanium 454 FLX pyrosequencing platform. The theory of this approach is based on sequencing-by-synthesis. For 16S sequencing, genomic DNA is fractionated into smaller fragments (300-800 base pairs). Then a single-stranded template DNA is used to generate an amplicon library which then undergoes an emulsion-based clonal PCR. This PCR uses beads coated in oligonucleotides, which are specific to adaptor sequences attached to the amplicons. Each bead carries a unique single-stranded library fragment and these amplicon-coated beads are added to a PicoTiterPlate™ (the plate consists of approximately one million wells, and each well contains at most one bead carrying a copy of a unique single-stranded DNA fragment to be sequenced) and sequencing ensues. Sequencing involves an enzymatic reaction and, as each nucleotide is sequentially added, pyrophosphate is released and ATP is subsequently generated. This then enables the conversion of luciferin and the emission and detection of photons of light.

Briefly, samples of DNA were amplified for pyrosequencing using a forward and reverse fusion primer. The forward primer was constructed with (5'-3') the Roche A linker (CCATCTCATCCCTGCGTGTCTCCGACTCAG), an 8-10 bp barcode, and specific primer Gray28F (5'-GAGTTTGATCNTGGCTCAG-3'). The reverse fusion primer was constructed with (5'-3') a biotin molecule, the Roche B linker (CCTATCCCCTGTGTGCCTTGGCAGTCTCAG), and specific primer Gray519R (5'-GTNTTACNGCGGCKGCTG-3'). Amplifications were performed in 25 ul reactions with Qiagen HotStar Taq master mix (Qiagen Inc, Valencia, California), 1

---

ul of each 5 uM primer, and 1ul of template. Reactions were performed on ABI Veriti thermocyclers (Applied Biosystems, Carlsbad, California) under the following thermal profile: 95°C for 5 min, then 35 cycles of 94°C for 30 sec, 54°C for 40 sec, 72°C for 1 min, followed by one cycle of 72°C for 10 min and 4°C hold.

Amplification products were visualized with eGels (Life Technologies, Grand Island, New York). Products were then pooled equimolar and each pool was cleaned with Diffinity RapidTip (Diffinity Genomics, West Henrietta, New York), and size selected using Agencourt AMPure XP (BeckmanCoulter, Indianapolis, Indiana) following Roche 454 protocols (454 Life Sciences, Branford, Connecticut). Size selected pools were then quantified and 150 ng of DNA were hybridized to Dynabeads M-270 (Life Technologies) to create single stranded DNA following Roche 454 protocols (454 Life Sciences). Single stranded DNA was diluted and used in emPCR (emulsion-based PCR) reactions, which were performed and subsequently enriched. Sequencing following established manufacture protocols (454 Life Sciences) was performed on the Genome Sequencer FLX instrument as described by Bailey et al. (2010). For a detailed description of pyrosequencing operation and protocol, refer to Ishak and colleagues (Ishak et al., 2011).

### 6.3 Results

To characterize and compare bacterial succession in the large intestines of neonates, fecal samples from 9 healthy and full term babies (total 50 samples collecting points) were analyzed from birth to 7 months using 454-pyrosequencing. The study population comprised 6 boys and 3 girls. Five infants (56%) were born by caesarean section and 4 infants (44%) were born by vaginal delivery. Five infants were partially breast-fed for 3-5 weeks and 4 infants were not breast-fed. There were 7 infants in the probiotic group and 2 infants in the placebo group. Faecal samples were provided as detailed in Table 6.2. High variability was observed in the profiles of faecal microbiota among the infants according to mode of delivery and administration of probiotic / placebo.

6.3.1 Composition of neonatal gut microbiota with different modes of delivery

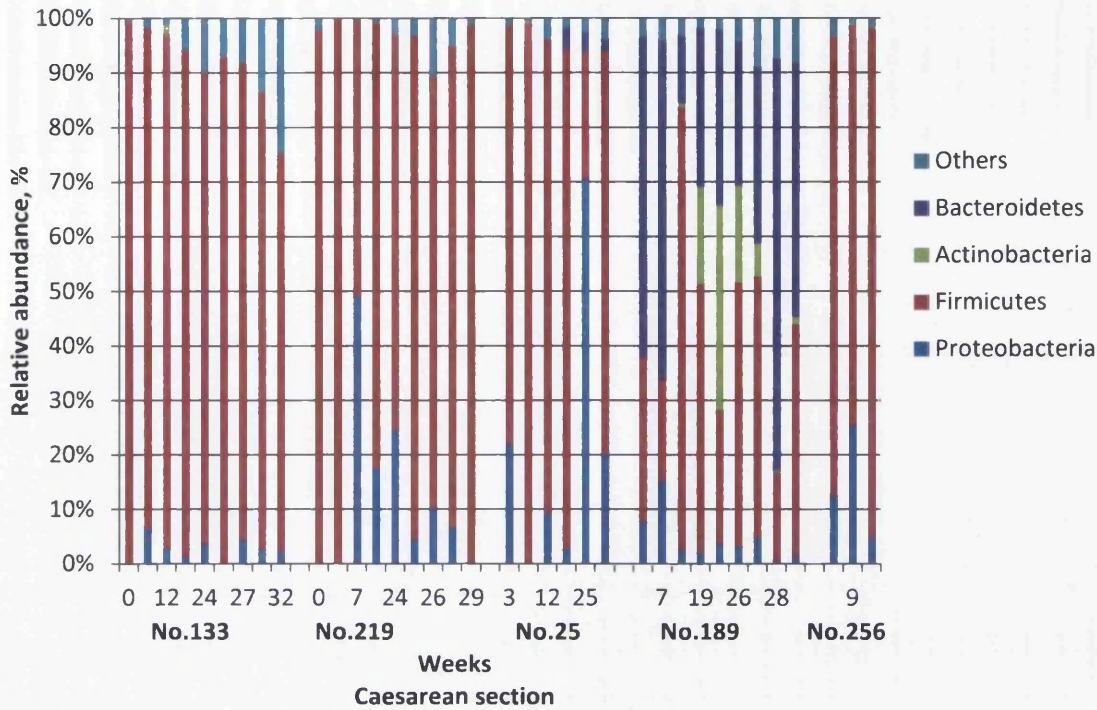

Figure 6.2 Microbial distributions at the phylum level for 5 caesarean section babies.

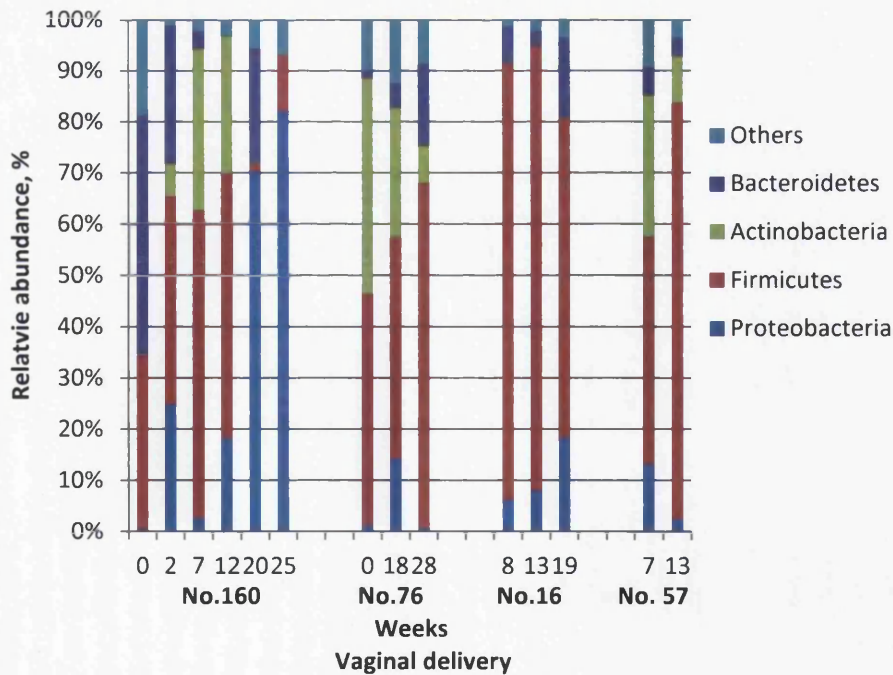

Figure 6.3 Microbial distributions at the phylum level for 4 vaginal delivery babies.



Differential abundance of bacterial taxa at the phylum levels for 5 caesarean section babies and 4 vaginal delivery babies were assessed, see Figure 6.2 and Figure 6.3. The profiles were generally dominated by Firmicutes, Actinobacteria, Proteobacteria and Bacteroidetes. Over the neonatal period (between 0-7 months according to individual samples collection points), the Firmicutes phylum level was significantly higher than all other phyla (except for No.189) in the caesarean babies (Figure 6.2). The difference in baby No.189 can be explained by antibiotic use for 7 days during the first 6 months. In general, antibiotic use will disrupt the microbiota profile in the human colon. Faecal microbiota profiles were dominated by the four phyla including Firmicutes, Proteobacteria, Actinobacteria and Bacteroidetes and showed high diversity in the phyla level in the vaginal delivery babies (Figure 6.3). Compared with babies who were delivered vaginally, babies born by caesarean section had bacterial communities with absence of Actinobacteria and Bacteroides (except for No.189).

### 6.3.2 Composition of neonatal microbiota in the placebo group

Differential abundance of bacterial taxa at the phylum and family levels for 2 healthy infants without probiotic administration were also assessed. One infant (No.133) was born by caesarean section and the other (No.160) was born by vaginal delivery. The relative abundance of residential bacterial phyla and families for each infant is shown in Figure 6.2, Figure 6.3 and Figure 6.4.

Over the neonatal period, the Firmicutes phylum level was significantly higher than all other phyla, ranging from 73.0-99.6% in the caesarean baby (No.133). Sequence assignments on lower taxonomic levels revealed that the phylum Firmicutes was largely made up of the family *Staphylococcaceae* and consisting mainly of the genus *Staphylococcus* at the first day after birth. The family *Streptococcaceae* and *Lactobacillaceae* reached the highest relative abundances at 6 and 12 weeks respectively (88.5% and 80.9%). However, *Lactobacillaceae* were not detected after 24 weeks. *Streptococcaceae* have a relative low abundance after 12 weeks compared with 6 weeks. The relative abundance of the family *Enterococcaceae* and

---

*Lachnospiraceae* were relatively higher than others from 18 to 32 weeks. The relative abundance of the family *Erysipelotrichaceae* was detected at 29 and 32 weeks. The family *Enterobacteriaceae* within the Proteobacteria phylum and the family *Clostridiaceae* within the Firmicutes phylum were also detected at lower levels during 6-32 weeks. From the above observation, *Staphylococcaceae* predominated in neonatal faeces on the first day, followed by *Streptococcaceae*, while *Lactobacillaceae* did not seem to form a stable population and could not be detected after 24 weeks in the caesarean baby.

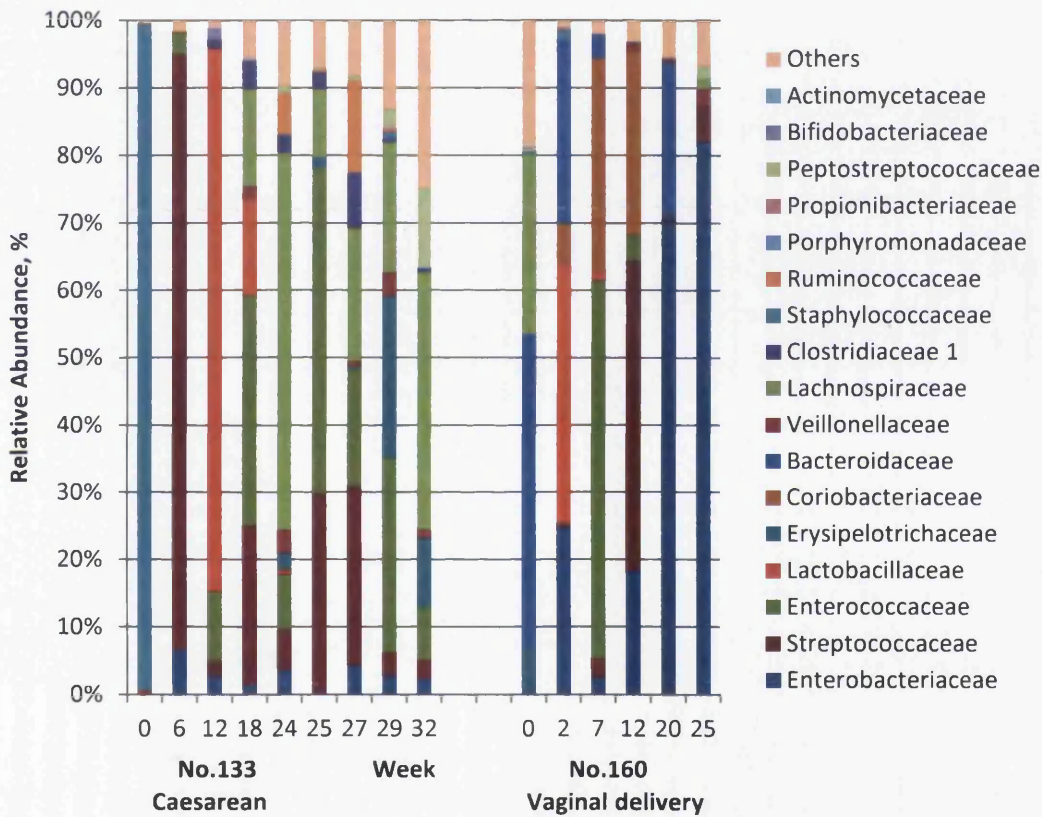

Figure 6.4 Microbial distributions at the family level for 2 infants from the placebo group.

Faecal microbiota profiles were dominated by the four phyla including Firmicutes, Proteobacteria, Actinobacteria and Bacteroidetes in the vaginal delivery baby (No.160). He showed higher diversity in the phyla level compared with the caesarean baby and also showed high *Bacteroides* population level which is not common in the healthy infant (Jost et al., 2012). The family *Enterococcaceae* is quite common in

two modes of delivery babies during the first six months. The family *Lactobacillaceae* was also not stable and only detected at 2 and 7 weeks in the vaginal delivery baby. The family *Coriobacteriaceae* within the Actinobacteria phylum was detected between 2 to 12 weeks, while it was absent in the caesarean baby. The family *Enterobacteriaceae* was predominant after 20 weeks in the vaginal delivery baby, while it was detected at very low level in the caesarean baby.

### 6.3.3 Composition of neonatal gut microbiota in the probiotic group

Differential abundance of bacterial taxa at the family levels for 4 healthy infants in the probiotic group was also assessed, who have intervention (0-24 weeks) and post-intervention samples (after 24 weeks) (Figure 6.5).

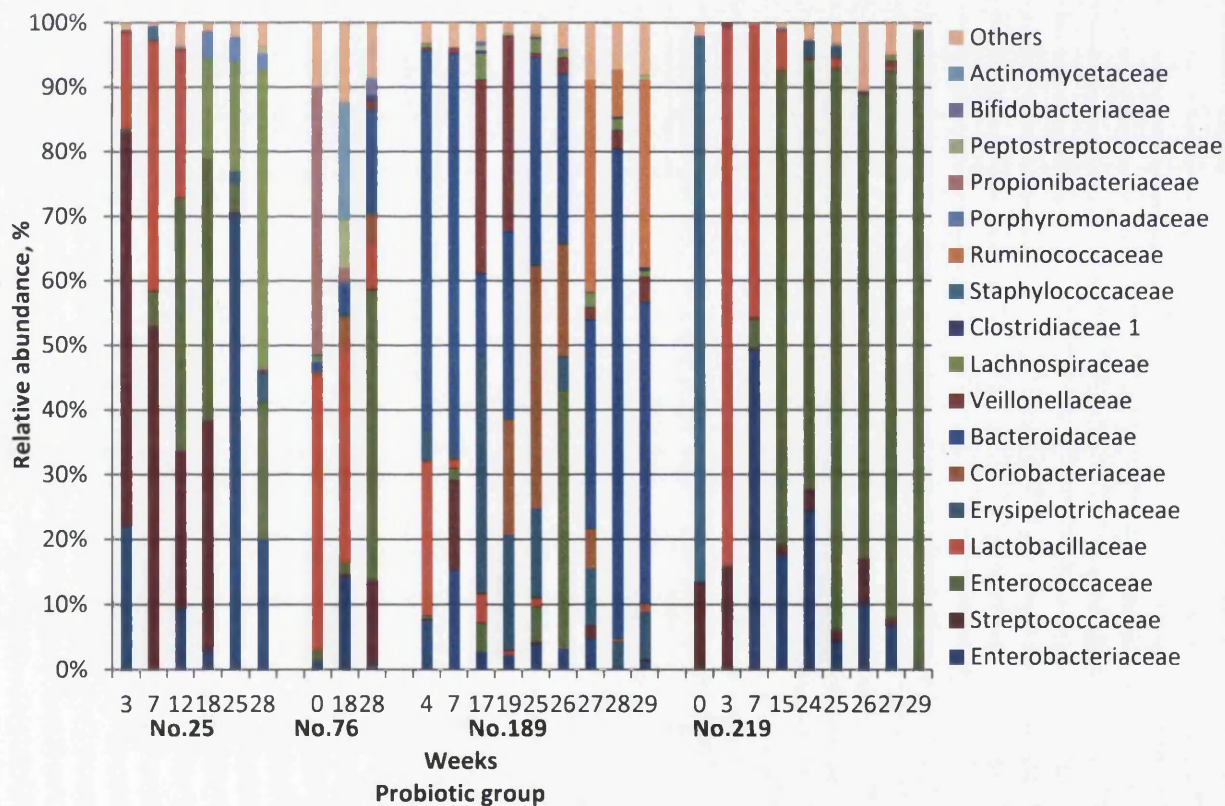

Figure 6.5 Microbial distributions at the family level for 4 infants with intervention and post-intervention samples (cease the probiotic administration after 24 weeks) in the probiotic group.

Shown in Figure 6.5, the composition and temporal patterns of the microbiota community vary widely from individual to individual. It shows the remarkable degree of inter-individual variation in the colonization process. For example, the family *Streptococcaceae* predominated during the first 18 weeks in baby No.25 and the family *Lactobacillaceae* predominated during the first 18 weeks in baby No.76. However, the family *Bacteroidaceae* predominated through the whole sample collection period from 4 to 29 weeks in No.189, but was virtually absent at this stage in other babies. The family *Staphylococcaceae* predominated on the first day in baby No.219, while it was not detected in other babies.

The second distinct feature is the relative stability of the microbial community in each baby over intervals of weeks to months although there still is considerable temporal variation. Bacteroides, for example, dominated the early microbiota of baby No.189 in the first 7 months which may be explained by the antibiotic use in the first six months. The family *Enterococcaceae* became absolutely dominant and very stable from 15 to 29 weeks in baby No.219 and the family *Streptococcaceae* was also very stable during the first 18 weeks in baby No.25.

A third striking feature of this dataset is that the family *Lactobacillaceae* was still detectable during the post-intervention period (the probiotic consumption ceased after 24 weeks) in the probiotic group. During the post-intervention period, the relative abundance of *Lactobacillaceae* was 7.2-1% in the probiotic group (except for No.25). The family *Lactobacillaceae* disappeared after 25 weeks in one baby, while it was still detectable until 28 weeks in some babies. The results show that administration of probiotics to healthy infants may be an effective way to change their gut colonization with healthy bacteria.

#### **6.3.4 Composition comparison between the probiotic and placebo groups**

To characterize and compare the composition of gut microbiota of neonates in the probiotic and placebo groups, two babies (one is in the probiotic group and the other is in the placebo group) were selected based on the same delivery mode (vaginal

---

delivery) and diet (breast feeding) without antibiotic use. Differential abundance of bacterial taxa at the family level was assessed, as shown in Figure 6.6.

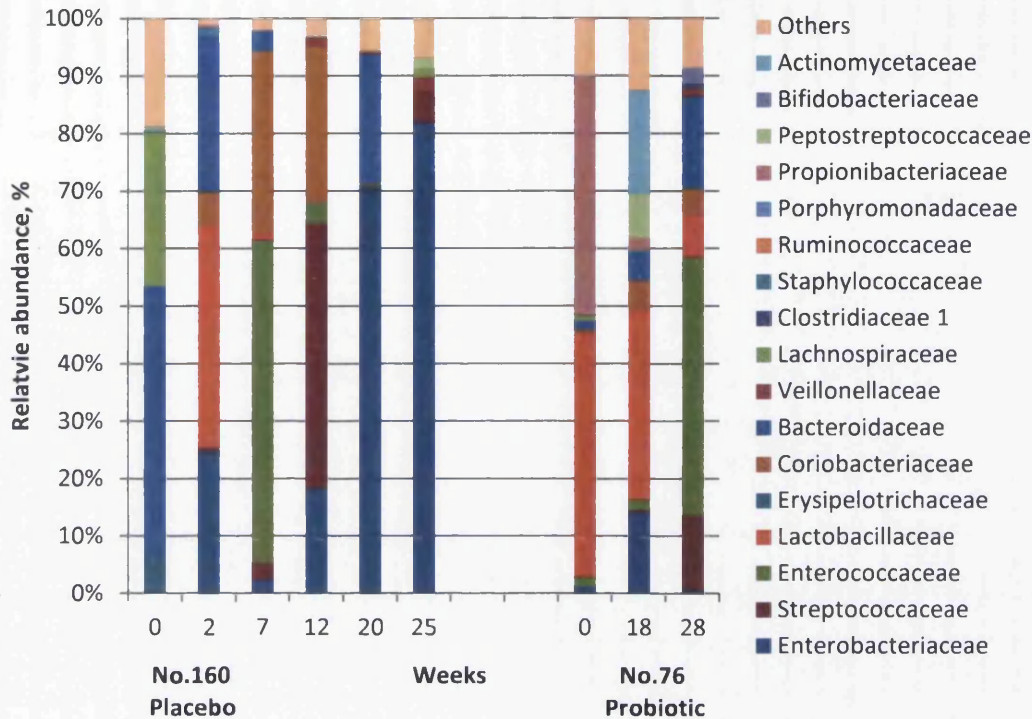

Figure 6.6 Microbial distributions at the family level for two infants in the placebo and probiotic groups, respectively. They were both vaginal delivery and breast fed during the first 3-5 weeks.

Results show that the family *Lactobacillaceae* reached the highest relative abundances at 2 weeks (38.5%) while it was not detected after 7 weeks in baby No.160 (placebo group). However, the family *Lactobacillaceae* was detected in the first week in baby No.76 (probiotic group) and the relative abundance was quite high in the first week and 18 weeks (44.2% and 33%, respectively). It was also detected at a high relative abundance (7.2%) in the post-intervention period (28 weeks). From the above observation, *Lactobacillaceae* did not seem to form a stable population in the placebo group, while it could still be detected for the probiotic group in the post-intervention period (28 weeks). In contrast, *Enterobacteriaceae* significantly decreased over the supplementation period in the probiotic group compared with the placebo group. The relative abundance of the family *Enterobacteriaceae* was significantly higher at 20 and 25 weeks in the placebo group (70.4% and 82%,

respectively). However, *Enterobacteriaceae* reduced from 14.2% (18 weeks) to 0.7% (28 weeks) in the probiotic group.

The above results show that *Lactobacillaceae* still had a quite high relative abundance in the probiotic group even in the post-intervention period. Also, *Enterobacteriaceae* significantly reduced in the probiotic group compared with the placebo group.

## 6.4 Discussion

This study applies the high-throughput gene sequencing technology to characterize the gut microbiota of healthy infants. Among a few studies on the investigation of neonatal gut microbiota diversity using gene sequencing methods, most were conducted on restricted populations, such as caesarean section or vaginal delivery infants, breast-fed or formula-fed infants, and preterm infants with necrotizing enterocolitis (Nakayama et al. (2011); Hong et al. (2010); Mai et al. (2011)).

This study uses the 454-pyrosequencing technology to analyse the microbiota profiles of 50 faecal samples from 9 healthy infants, which are selected from the randomized, double-blinded and placebo-controlled trials conducted by Swansea University and Cultech Ltd. These nine infants include different modes of delivery and different modes of feeding, and they received either probiotic supplement or placebo during the first 6 months after birth. The study provides comprehensive profiles of the neonatal gut microbiota in healthy babies, and it also provides guidance for future analysis of neonatal samples from those infants with high risk of atopy, the second trial group in Swansea's clinical trials.

Historically, the gut microbiota has been studied using culture-based methodologies to examine individual organisms. However, accurate analysis of the entire microbial community in the neonatal GI tract has been difficult since up to 80% of intestinal microorganisms are believed to be un-cultivable (Fouhy et al. (2012b); Fraher et al. (2012)). Recent progress in molecular techniques using high-throughput sequencing

---

called pyrosequencing enables comprehensive detection of microbiota profiles and permits simultaneous characterization of entire microbial communities (Bailey et al. (2010); Hong et al. (2010); Stecher et al. (2010); Nakayama (2010); Zoetendal et al. (2008)). This approach provides a clear view of neonatal microbiota diversity and overcomes the limitations of target-specific microbiota analyses such as quantitative real-time PCR (q-PCR), fluorescence in situ hybridization microscopy (FISH), or colony counts.

The profiles were generally dominated by four phyla including Firmicutes, Actinobacteria, Proteobacteria and Bacteroidetes. Compared with infants who were delivered vaginally, the Firmicutes phylum level in the caesarean section babies was significantly higher than all other phyla (except for one baby who took an antibiotic for 7 days during the first 6 months) during the neonatal period (between 0-7 months). This shows that antibiotic may disrupt the microbiota profile in the human colon. Vaginal delivery babies showed high diversity in the phyla level including the four phyla mentioned above. These results show that microbiota development is strongly influenced by the mode of delivery which matches the previous study for gut microbial composition in early infancy (Penders et al., 2006). Caesarean delivery leads to a delayed increase in population density of the major gut-associated microbes because these babies have not been in contact with the maternal vaginal and faecal flora (Adlerberth et al., 2007).

Sequence assignments on lower taxonomic levels in this study revealed that facultative anaerobic bacteria, mainly the family *Staphylococcaceae*, *Streptococcaceae*, *Lactobacillaceae*, *Enterococcaceae* and *Enterobacteriaceae* are the pioneering colonization bacteria in early infancy. These bacteria can originate from the vagina, the skin, mouth and the surrounding environment. The results also show a large inter-individual variability amongst infants during the first six months of life, which matched the results in a few studies that observed high variability of gut microbiota between infants (Abrahamsson et al. (2012); Roger et al. (2010); Hong et al. (2010); Palmer et al. (2007); Penders et al. (2006)). Despite considerable

---

composition and temporal variation of microbial communities between individuals, most individuals were relatively stable over time and the distinct structures of each neonatal microbial community were noticeable. Prior to 6 months of age, faecal sample analysis from 9 healthy infants indicate that the differences from baby to baby were much greater than the changes over periods of weeks or months in the composition of any individual neonatal gut microbiota.

Recent reports indicate that routine use of probiotic in the neonatal intensive care has been safe and well tolerated over a period of several years (from 5 to 12 years) (Manzoni et al. (2011); Luoto et al. (2010); Allen et al. (2010)). There is an interest in full term infants given probiotics or prebiotics to focus on prevention of allergic disease and food hypersensitivity. The question to answer is whether or not probiotic, prebiotic or synbiotics can favourably alter the infant gut microbiota in early life to benefit atopic children. Several clinical trials associated with administration of specific probiotic in early life to decrease risk of developing eczema have been reported (Rautava et al. (2012); Johansson et al. (2011); Kim et al. (2010); Dotterud et al. (2010); Niers et al. (2009); Wickens et al. (2008); Kukkonen et al. (2007); Kalliomaki et al. (2001)). These published trials include both prenatal and postnatal probiotic administration and have shown benefits in reducing disease risk.

On the basis of available evidences, it appears that probiotic intervention is most effective in reducing the risk of eczema in the infant if started during pregnancy. Tang et al. (2010) comprehensively reviewed the clinical effect of probiotic and prebiotics in allergic diseases. The meta-analysis used in the review suggests that a prenatal administration of probiotic is important for beneficial effects and it is also important to continue the treatment for the maximum effect. For example, maternal probiotic supplementation during pregnancy and breast-feeding have shown promising potential in reducing the risk of eczema in infants (Rautava et al., 2012). For children with allergic parents, higher levels of lactobacilli in early life did reduce the risk of allergy development at age 5 years (Johansson et al., 2011). However, one study with both prenatal and postnatal interventions shows lack of effect (Kopp et al.,

---



2008). Another two clinical trials in which probiotic administration is given only postnatally and directly to the infants have negative results (Taylor et al. (2007); Soh et al. (2009)). Treatment of probiotics solely in the postnatal period has not proved beneficial (Tang et al., 2010).

Indeed, all the above clinical trials have involved administration of specific strains, highlighting the importance of assessing each probiotic strain individually. A major strength of this study is the application of new high-throughput gene sequencing technology (454-pyrosequencing) to characterize the complex gut microbiota in 9 healthy infants with specific probiotic strain / placebo administration from Cultech Ltd. The probiotic product was administered at the last week of pregnancy and to baby for the first 6 months. Faecal samples from 7 infants (probiotic group) and 2 infants (placebo group) were collected during the first six months of life and 4 weeks post-supplementation. The results show that probiotic did alter the composition of the gut microbiota compared with those in the placebo group. The family level of *Lactobacillaceae* was still detectable in the probiotic group until 28 weeks of the post-intervention period, while it was usually colonized in the first few weeks in the placebo group and did not seem to form part of the stable population at 24 weeks.

In contrast, *Enterobacteriaceae* significantly decreased over the supplementation period in the probiotic group compared with the placebo group. This observation has also been found in other studies (Fouhy et al. (2012b); Kitajima et al. (1997)). However, as we only analyzed the samples from a small number of babies, the general nature of our findings need to be tested in studies involving a larger number of individuals.

One notable discrepancy between our study and many others is the relatively low frequency and abundance of bifidobacteria in the faecal microbiota as part of the dominant microbiota during the neonatal period. There are several possible reasons for this. In general, samples from the GI tract use universal primers for amplification of the bacterial 16S rRNA gene followed by pyrosequencing to reveal the gut microbiota diversity. The universal primers aim to amplify as many 16S rRNA gene

---

sequences as possible from a wide range of microorganisms. However, there are no suitable primer to amplify 100% conserved regions of the gene. Also, underestimation of diversity may result from differential PCR amplification caused by differences in the efficiency of primer binding (Wang et al., 2005). In the GI tract, bifidobacteria are a key genus, but are often under-represented in 16S rRNA surveys of diversity (Sim et al., 2012). The study of Palmer et al. (2007) revealed that the overall efficiency of amplification of DNA from bifidobacterial species was eight fold lower than that from non-bifidobacterial species using the 8F/1391R primer pair. The presence of thick cell walls may be another reason that Gram-positive organisms (such as bifidobacteria) can be underrepresented in microbial profiling studies (de Boer et al., 2010).

Sim et al. (2012) have modified the universal primers for bifidobacteria, which could detect bifidobacterial gene sequence at 2% abundance. However, the modification did not improve the detection of other microorganisms in neonatal faecal samples. For future studies of the microbiota diversity in the neonatal gut, careful selection of primers will be the key step in order to ensure effective detection of bifidobacteria.

Based on culture-dependent analysis conducted at Cultech Ltd., UK the viable counts of bifidobacteria in all 9 neonatal faecal samples selected for this study are quite high, ranging from  $1 \times 10^8$  to  $1 \times 10^{10}$  cfu/g (personal communication). Thus, even with the advent of advanced high-throughput gene sequencing technology, culture and isolation still remains a valuable and practical approach for studying phenotypic and genotypic characteristics of specific strains of interest (e.g. probiotics). Thus in order to provide strong and unbiased evidence when studying the complex microbiota in the neonatal gut, the combining of culture-dependent and culture-independent methods should be considered.

## 6.5 Conclusion

This study employed the 454-pyrosequencing technique to characterize the gut microbiota in healthy infants, and assessed the effects of diet, environment and

---

probiotic administration. These findings advance our understanding of gut microbiota diversity in healthy infants. The current study concerns only the first subject group (healthy infants) in the clinical trials conducted by Swansea University and Cultech Ltd. But the results obtained also provide a useful reference for future investigation of the second subject group (atopic infants), to examine the correlation between faecal microbiota composition and the prevalence of allergic diseases in late infancy. However, due to the cost constraint, the sample size is rather small here and the interpretation of results must be made with caution. More studies need to be undertaken to learn about the infant gut microbiota, together with its role in health and disease. What constitutes a healthy gut microbiota ecosystem? How long do they persist? Are bacterial richness and diversity fundamentally important? How environmental and genetic factors, infections during infancy, or antibiotic use drive the colonization of the infant gut? How does early establishment of the gut microbiota influence the host's health and disease later in childhood? All these questions will be important goals for future investigations.

## Chapter 7 Computer Simulation of *In Vitro* Fermentation Experiments

### Abstract

Mathematical / computational modelling provides an alternative approach to study the gut microbial ecosystem, and it can overcome some of the difficulties faced by *in vivo* trials and *in vitro* experiments. A new microbial growth model is proposed in this Chapter. The new model is a natural extension of the classic Monod model, but instead of predicting competitive exclusion, the new model intrinsically supports steady-state coexistence of microorganisms. Based on the new microbial growth model, a robust and versatile computational framework is developed to simulate *in vitro* fermentation experiments, including batch, chemostat and multi-stage chemostat fermentations. The new computational model is extensively validated using the *in vitro* experiments described in the earlier chapters, and very good agreement is observed in all validation examples. This Chapter also shows how the computer simulation can help to better interpret experimental data and predict new results.

## 7.1 Introduction

As a promising approach that can overcome some of the difficulties faced by *in vivo* trials and *in vitro* experiments, the potential of benefit from mathematical / computational modelling to the study of gut microbial ecosystem has long been recognized (see the review in Section 2.4). These potential benefits and advantages include:

- Interpretation of experimental results. Conditions in mathematical / computational modelling are fully controlled, and by correlating the virtual experiment results with the data from *in vivo* or *in vitro* testing, a better insight can be gained to the real experiments.
- Time and cost saving on similar experiments. Once the effectiveness of the mathematical / computational model has been proved, it can be used to predict the results for similar experiments, significantly reducing the time and cost required for new *in vivo* and *in vitro* testing.
- Implementation of increased complexity and prolonged testing period. Through mathematical / computational modelling, it is relatively easy to simulate complex conditions that are difficult to measure or implement in *in vivo* or *in vitro* testing, and the virtual experiment can also allow simulation for longer period, which are often difficult, or even impossible, to achieve in real testing.
- Quick examination of hypothesis and parameter sensitivity to eliminate unnecessary *in vivo* or *in vitro* experiments. Mathematical / computational modelling allows hypothesis and parameter sensitivity to be quickly tested, such that those assumptions that result in effects contrary to evidence and those parameters that have little impact on the results can be eliminated when planning *in vivo* or *in vitro* experiments.
- Scaling up from component-level experiments to system-level simulation. Once the mathematical / computational models have been validated for individual functional components, they can be integrated to predict the

behavior of the whole system, which is often too expensive or too time-consuming, to study using *in vivo* or *in vitro* approaches.

The aim of this part of the work is to develop appropriate mathematical models and computer programs, to simulate various *in vitro* fermentation experiments with different microbial species, nutrient supplies and environmental factors. The objectives include:

- To critically review the existing computer simulation approaches for *in vitro* fermentation and microbial competition.
- To develop an accurate and versatile mathematical model and build a robust simulation platform for *in vitro* fermentation and microbial competition.
- To verify and validate the proposed mathematical model and associated codes using the *in vitro* fermentation experiments conducted in the first part of this research.
- To explore feasibility, accumulate experience and prepare building blocks for the development of a complete computational model for the human gut and the gut microbial ecosystem.

As reviewed in Section 2.4 (see Table 2.2), previous research works in mathematical / computational modelling of gut microbiota have either adopted the chemostat model or the plug flow model to simulate the GI tract. When the chemostat model is adopted (Freter et al. (1983a, 1983b, 1983c, 1983d); Freedman et al. (1989); Coleman et al. (1996); Stemmons et al. (2000); Ballyk et al. (2001); De Jong et al. (2007); Munoz-Tamayo et al. (2010, 2011); Lawson et al. (2011)), the evolution of the virtual system is predominantly driven by the fermentation activity of microorganisms. When the plug flow model is adopted (Ballyk et al. (1998, 1999, 2001); Jones et al. (2000, 2002)), depending on whether or not the random motility assumption of bacteria is made, the evolution of the virtual system is driven in two different ways. Without the random motility assumption (Jones et al. 2000), the plug flow model is purely driven by the fermentation activity of microorganisms, same as

the chemostat model. With the random motility assumption (Ballyk et al. (1998, 1999, 2001); Wilkinson (2002a, 2002b, 2002c); Jones et al. (2002)), the plug flow model is jointly driven by the fermentation activity and the diffusion effect.

Fermentation activity is a core module in all previous virtual gut models, and its simulation has always been based on the classic Monod growth model (see Table 2.2). Named after Jacques Lucien Monod, the Monod growth model is an empirical formula for microbe growth, and it states that the specific growth rate  $\mu$  of a microbe growing on a single nutrient supply is

$$\mu = \frac{\mu_{\max} S}{K + S}, \quad (7.1)$$

where  $S$  is the concentration of the limiting substrate,  $\mu_{\max}$  is the maximum specific growth rate of the microorganism, and  $K$  is the half-velocity constant.

However, when applying the Monod model to microbial competition, it leads to a conclusion of competitive exclusion, i.e. multiple microorganisms cannot coexist stably on limited number of nutrient supplies. The competitive exclusion prediction contradicts directly to common observation that microorganisms always coexist in real-world environment and pure cultures are almost always the managed result from microbiologists.

To overcome this paradox of competitive exclusion, previous researchers have introduced various external factors into the Monod growth equation, such as time-varying inputs (Fredrickson et al. 1981), diversity of resources (Freter et al. (1983a, 1983b, 1983c, 1983d); Wilkinson (2002a, 2002b, 2002c); Munoz-Tamayo et al. (2010, 2011); Lawson et al. (2011)), time-delay factors (Freedman et al. 1989), spatial heterogeneity (Fredrickson et al. (1981); Wilkinson (2002a, 2002b, 2002c), random motility (Ballyk et al. (1998, 1999, 2001); Wilkinson (2002a, 2002b, 2002c); Jones et al. (2002)), and wall attachment etc (Freter et al. (1983a, 1983b, 1983c, 1983d); Ballyk et al. (1999, 2001); Stemmons et al. (2000); Jones et al. (2000,

---

2002); Winkinson (2002a, 2002b, 2002c); Munoz-Tamayo et al. (2010, 2011)). These external factors typically appear as additional terms of different forms in the growth equation. But for all these modifications, competitive exclusion can still happen, and steady-state coexistence is often only a rare possibility of these models. Hence, it will be investigated independently in this research to seek a uniform model that intrinsically allows coexistence in microbial competition.

The rest of this Chapter is organized as follows. In Section 7.2, a mathematical model for batch fermentation is developed, and the corresponding simulation results are validated against the batch fermentation experiments described in Chapter 4. In Section 7.3, the batch fermentation model is extended to a chemostat fermentation model that can cope with an arbitrary number of connected chemostats, and the corresponding simulation results are validated against the continuous fermentation experiments described in Chapter 5. In Section 7.4, a theoretical analysis on steady-state coexistence of microorganisms is presented to show how the new growth model can overcome the paradox of competitive exclusion predicted by previous theories. Finally, concluding remarks are made in Section 7.5.

## **7.2 Modelling of batch fermentation**

A series of batch fermentation experiments were carried out in the first part of this research, for which the method and results are presented in Chapter 4. As listed in Table 7.1, four single-strain probiotics (CUL08, CUL61, CUL60 and CUL21) and two multiple-strain probiotics (LAB4 and LAB4B) were investigated. These probiotics strains are commercial products from Cultech / Obsidian Ltd, the industry partner of the project. For each of these fermentation studies, two different culture media were tested, including the commercially available culture medium MRS and the artificial gut medium MMGM. The initial pH condition was set at two different values, pH 5.5 to mimic the acid condition of the ascending colon and pH 6.5 to mimic the neutral environment at the descending colon. Both controlled pH and uncontrolled pH environments were examined.



Table 7.1 List of batch fermentation experiments conducted in this research

Cultech Organism	Medium	Uncontrolled pH	Controlled pH
<i>Lactobacillus paracasei</i> (CUL08)	MRS MMGM <sup>1</sup>	6.5 or 5.5 6.5 or 5.5	- 6.5 or 5.5
<i>Lactobacillus salivarius</i> (CUL61)	MRS MMGM <sup>1</sup>	6.5 or 5.5 6.5 or 5.5	- 6.5 or 5.5
<i>Lactobacillus acidophilus</i> (CUL60)	MRS MMGM <sup>1</sup>	6.5 or 5.5 6.5 or 5.5	- 6.5 or 5.5
<i>Lactobacillus acidophillus</i> (CUL21)	MRS MMGM <sup>1</sup>	6.5 or 5.5 6.5 or 5.5	- 6.5 or 5.5
LAB4 <sup>2</sup>	MMGM <sup>1</sup>	6.5 or 5.5	-
LAB4B <sup>3</sup>	MMGM <sup>1</sup>	6.5 or 5.5	-

<sup>1</sup> MMGM: modified Macfarlane's gut medium

<sup>2</sup> LAB4: *L. acidophilus* (CUL60), *L. acidophilus* (CUL21), *B. Lactis* (CUL34) and *B. bifidum* (CUL20).

<sup>3</sup> LAB4B : *L. salivarius* (CUL61), *L. paracasei* (CUL08), *B. Lactis* (CUL34) and *B. bifidum* (CUL20).

### 7.2.1 Single-strain batch fermentation

The single-strain batch fermentation is first considered. Let  $\beta_1$  denote the mass concentration of the probiotic strain and  $\beta_2$  denote the mass concentration of the substrate. In this work, the following ordinary differential equations are proposed to describe the change of mass concentrations for probiotic and substrate over time:

$$\frac{d\beta_1}{dt} = \frac{B\beta_2\beta_1}{C + \beta_2 + \varepsilon\beta_1} \quad (7.2)$$

$$\frac{d\beta_2}{dt} = -D \frac{B\beta_2\beta_1}{C + \beta_2 + \varepsilon\beta_1}, \quad (7.3)$$

where  $B$  is the maximum specific growth rate,  $C$  the velocity-delay constant,  $\varepsilon$  the interaction coefficient, and  $D$  the yield rate. In the above growth model, the

coefficient  $B$  corresponds to the maximum specific growth rate  $\mu_{\max}$  in the Monod model (7.1), and it represents the maximum possible value for the specific growth rate when there is a plentiful supply of nutrient. The velocity-delay coefficient  $C$  corresponds to the half-velocity constant in the Monod model (7.1), and it represents the delay effect when the substrate concentration is changed. The coefficient  $\varepsilon$  is a new assumption that does not exist in the Monod model or any previous models, and it represents the bulk interaction effect caused by the growth and presence of microorganisms. For example, metabolite products may gradually change the acid condition, and subsequently affects the following growth of microorganisms. The coefficient  $D$  represents the conversion rate between the substrate and the microorganism. Overall, the growth efficiency, i.e. how fast the microbe can grow on the given nutrient, is described by the parameters  $B$  and  $C$ ; the growth productivity, i.e. how much biomass can be grown from the limited nutrient, is described by the parameter  $D$ .

The motivation to introduce the new growth model in Eqns. (7.2-7.3) is twofold. First, the Monod model only provides a rough approximation to the *in vitro* test data, and in some cases the history-matching simply cannot be achieved. Secondly, the Monod model and its various modifications with external factors do not allow steady-state coexistence of microorganisms, while coexistence is intrinsically supported by the new model. The second point will be discussed in more detail in Section 7.4. It should be noted that, instead of being contradictory to the classic Monod model, the new model is an improvement by taking into account the various internal factors caused by bacteria interaction. Indeed, if  $\varepsilon = 0$ , the new model degenerates into the Monod model.

In all simulations, the unit for mass concentrations  $\beta_1$  and  $\beta_2$  is g/ml. According to the setup of the *in vitro* batch fermentation experiments, the initial mass concentration of the MRS medium was set as 0.053 g/ml and the mass concentration of the MMGM medium was set as 0.043 g/ml. Based on Cultech's technical specification of their probiotic strains, the number density of microorganisms was

---

estimated as  $1 \text{ g} = 10^{11} \text{ cfu}$ . The above settings have been retained the same in all *in vitro* experiments performed in this research.

Using Eqns. (7.2-7.3) to approximate, in the least-squares sense, the growth history measured from the *in vitro* experiments, the optimal parameters  $B$ ,  $C$ ,  $D$  and  $\varepsilon$  in the growth model can be determined. That is to find the parameter values in the growth model that best fit the real growth history measured from the *in vitro* batch fermentations. Then, using these calibrated parameters, the simulation is performed again to show the best-fit growth curve from the computational model. It should be noted that the growth model in Eqns. (7.2-7.3) only simulates the log phase and the stationary phase on the growth curve, while the lag phase and the death phase are not considered.

The simulation results corresponding to the single-strain batch fermentation experiments are given in Figures 7.1-7.4. It can be seen that very good agreement is achieved for all *in vitro* batch fermentation experiments. The history matching confirms the effectiveness of the proposed growth model in Eqns. (7.2-7.3). Corresponding to the simulations shown in Figures 7.1-7.4, the growth-model parameters are listed in Tables 7.2-7.5 respectively.

For the maximum specific growth rate  $B$ , it can be observed from Figures 7.1-7.4 that, with both MRS and MMGM media and in both controlled and uncontrolled pH conditions, the  $B$  value at the initial pH 5.5 is always lower than the corresponding value at the initial pH 6.5. This is in line with our expectation as the growth rate of most microorganisms is suppressed in acid environments. However, the sensitivity with respect to the pH change is different for different microbe species. Among the four tested probiotic species (CUL08, CUL61, CUL60 and CUL21), the CUL61 probiotic is most sensitive to pH change, and the other three probiotic species are more robust in terms of the growth rate. Between the two culture media, the MRS delivers a higher growth rate in general, which may be related its higher initial concentration at 0.053 g/ml in comparison to MMGM's concentration at 0.043 g/ml.

The conditions of controlled pH or uncontrolled pH do not have a significant and uniform impact on the growth rates.

For the velocity-delay constant  $C$ , no simple relations can be observed with respect to the change of initial pH, the change of culture media, or the change between controlled and uncontrolled pH conditions.

For the yield rate  $D$ , it can be observed in Figures 7.1-7.4 that the  $D$  value is always lower in controlled pH conditions. This indicates that the conversion rate from substrate to biomass is higher when the pH condition is controlled at a stable level. However, the conversion rate is not sensitive to the initial pH value and no clear correlation can be observed. Between the two culture media, the conversion rate for the MRS is higher than the MMGM.

For the interaction coefficient  $\varepsilon$ , it can be observed in Figures 7.1-7.4 that the  $\varepsilon$  value with the initial pH 5.5 is generally lower than the corresponding case with the initial pH 6.5. This is because the main metabolite products from these probiotics are lactate and acetate, which can gradually make the culture media more acid and in turn reduce the growth rate of microorganisms. When the initial condition is neutral, this acidizing suppression effect is more significant, compared with the acid initial condition. To some extent, this suppression effect can be reduced by controlling the pH at a stable level, which can also be observed in these figures. Clearly, the acid condition is not the only interaction route between microorganisms. The interaction modelled by the coefficient  $\varepsilon$  is also affected by the choice of culture media, either MRS or MMGM.

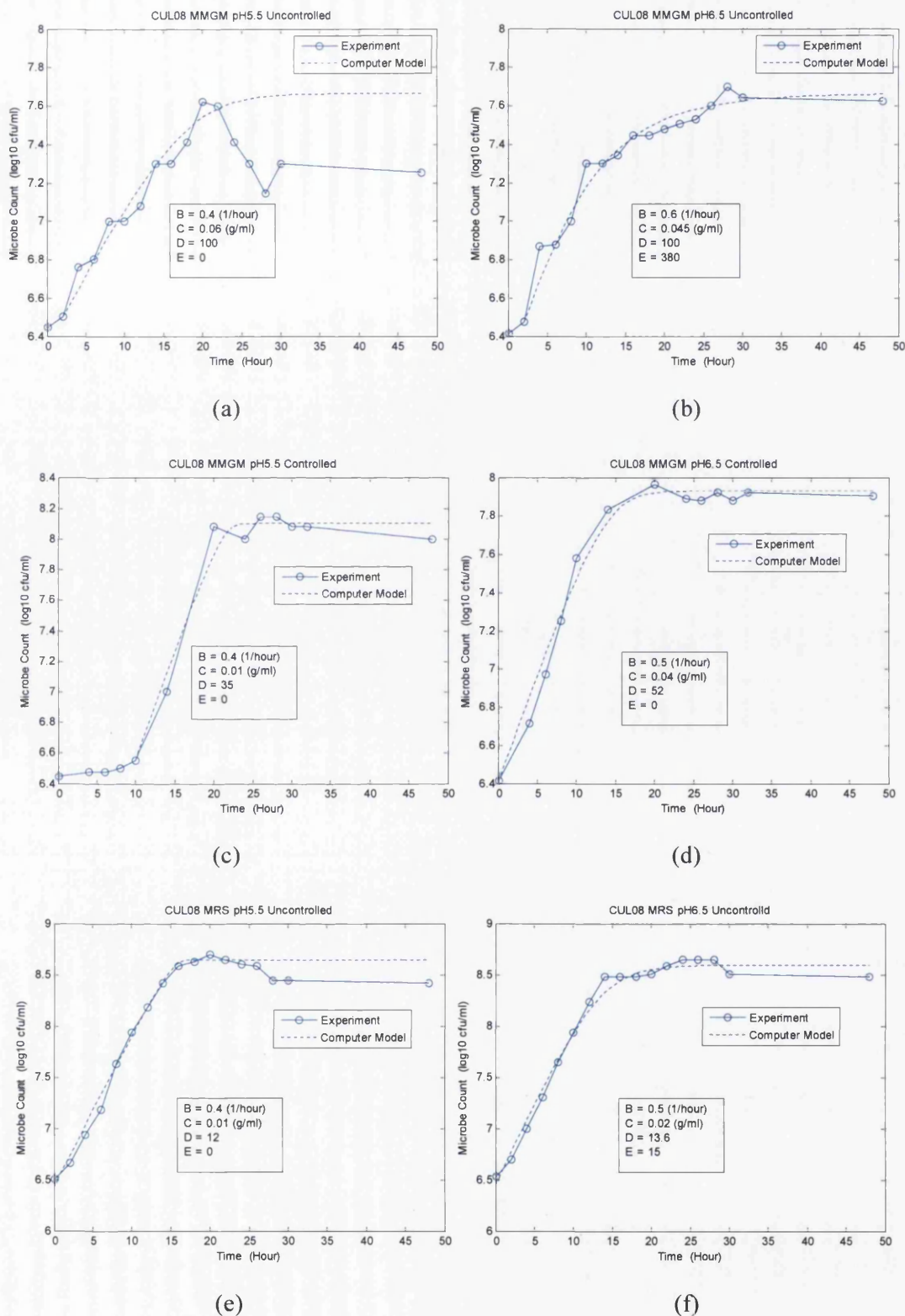

Figure 7.1 Computational modelling of *Lactobacillus paracasei* CUL08 in batch fermentations

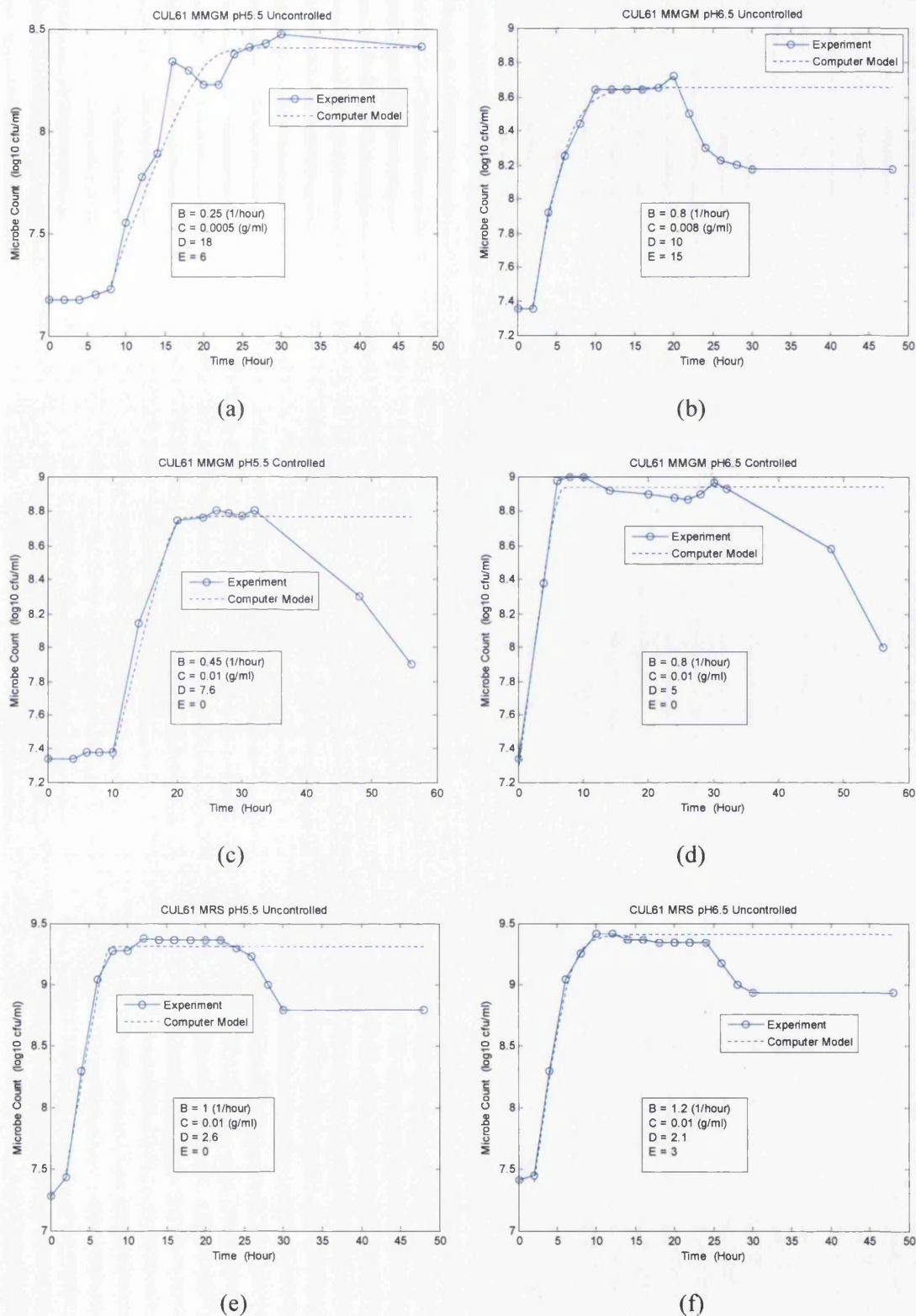
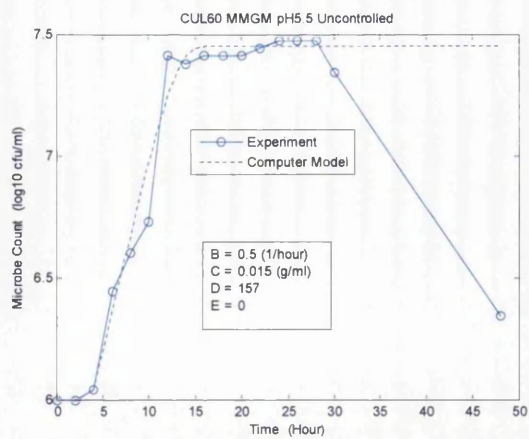
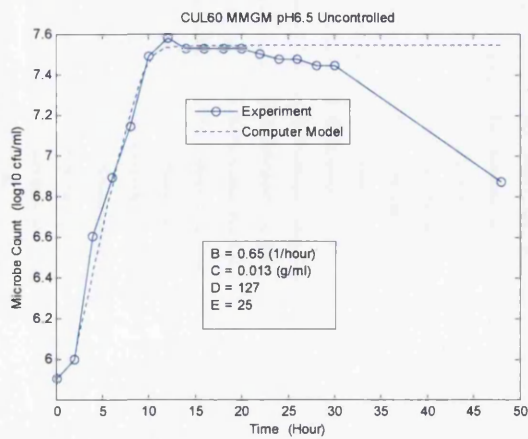

Figure 7.2 Computational modelling of *Lactobacillus salivarius* CUL61 in batch fermentations



(a)



(b)

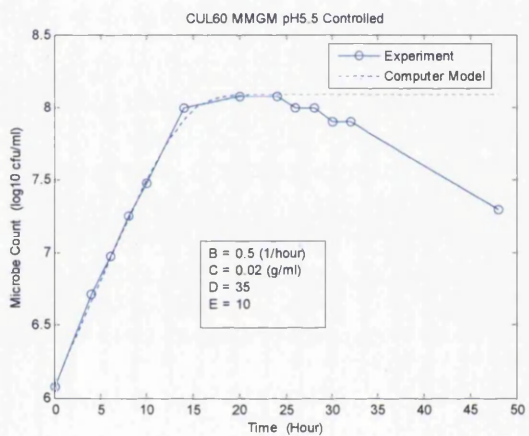

(c)

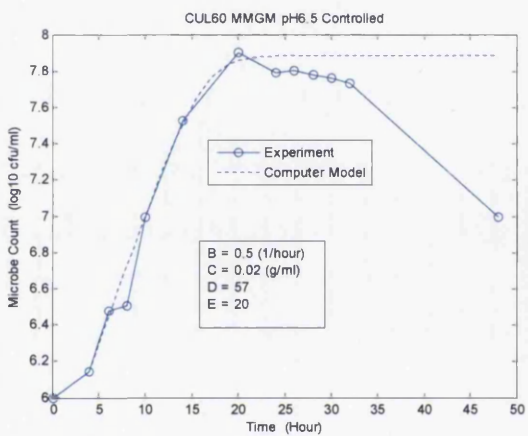

(d)

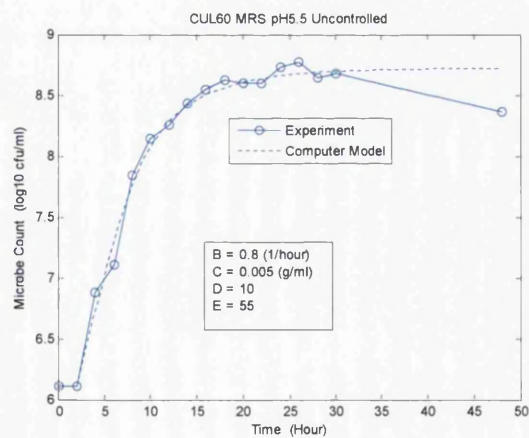

(e)

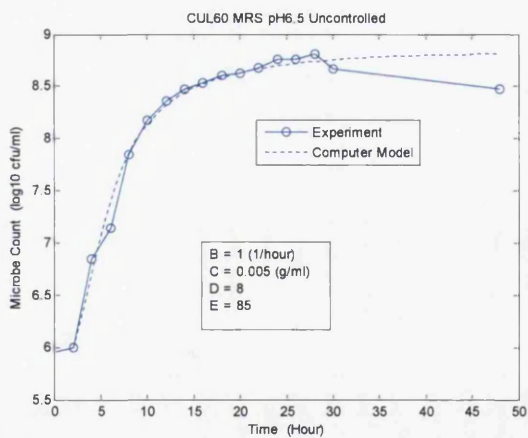

(f)

Figure 7.3 Computational modelling of *Lactobacillus acidophilus* CUL60 in batch fermentations

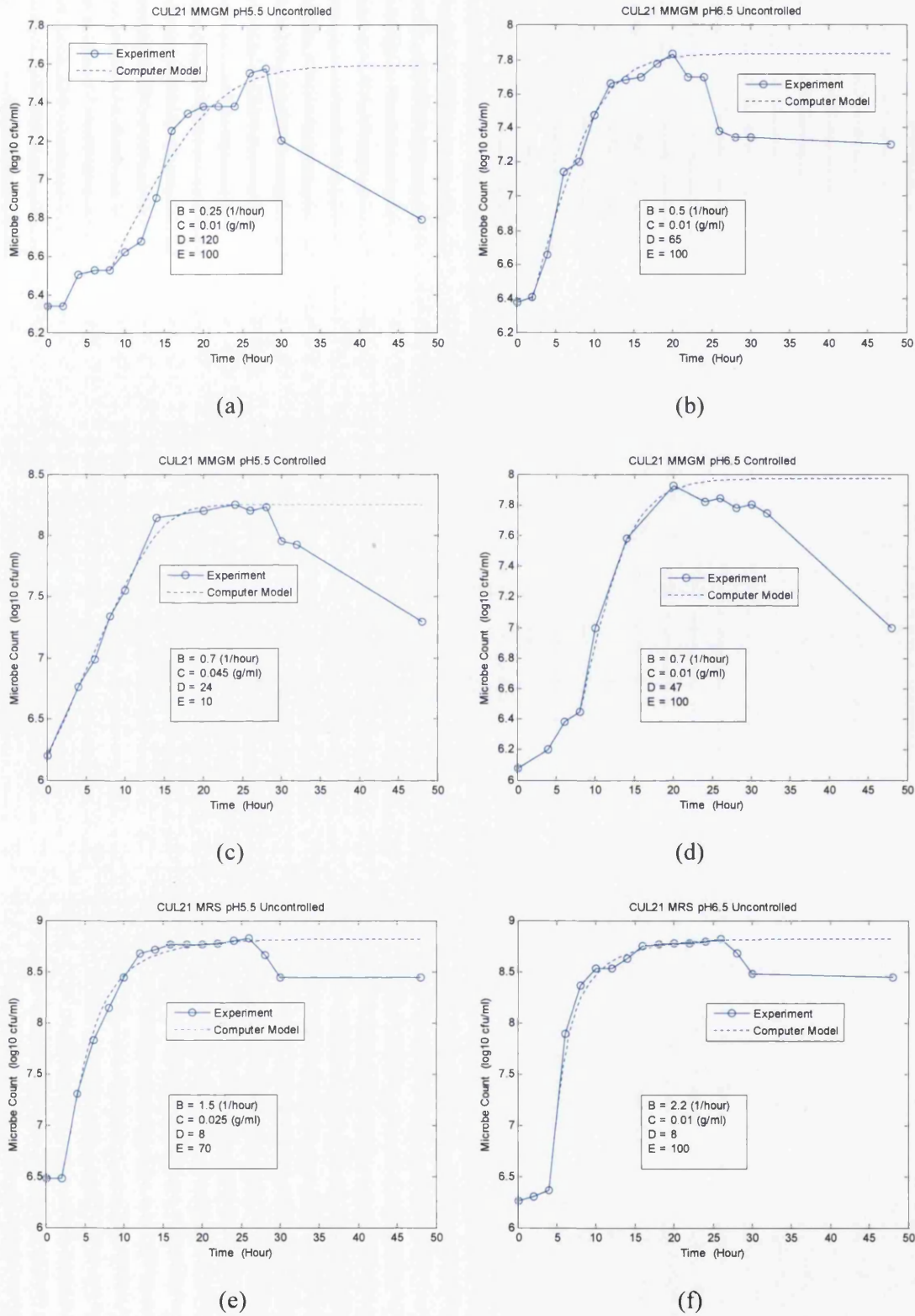

Figure 7.4 Computational modelling of *Lactobacillus acidophillus* CUL21 in batch fermentations



Table 7.2 Growth model for *Lactobacillus paracasei* CUL08 in batch fermentations

	<b>MMGM pH5.5 Uncontrolled</b>	<b>MMGM pH6.5 Uncontrolled</b>	<b>MMGM pH5.5 Controlled</b>	<b>MMGM pH6.5 Controlled</b>	<b>MRS pH5.5 Uncontrolled</b>	<b>MRS pH6.5 Uncontrolled</b>
<i>B</i>	0.4	0.6	0.4	0.5	0.4	0.5
<i>C</i>	0.06	0.045	0.01	0.04	0.01	0.02
<i>D</i>	100	100	35	52	12	13.6
$\varepsilon$	0	380	0	0	0	15

*B* : 1/hour; *C* : g/ml; *D* : dimensionless;  $\varepsilon$  : dimensionless

Table 7.3 Growth model for *Lactobacillus salivarius* CUL61 in batch fermentations

	<b>MMGM pH5.5 Uncontrolled</b>	<b>MMGM pH6.5 Uncontrolled</b>	<b>MMGM pH5.5 Controlled</b>	<b>MMGM pH6.5 Controlled</b>	<b>MRS pH5.5 Uncontrolled</b>	<b>MRS pH6.5 Uncontrolled</b>
<i>B</i>	0.25	0.8	0.45	0.8	1.0	1.2
<i>C</i>	0.0005	0.008	0.01	0.01	0.01	0.01
<i>D</i>	18	10	7.6	5	2.6	2.1
$\varepsilon$	6	15	0	0	0	3

*B* : 1/hour; *C* : g/ml; *D* : dimensionless;  $\varepsilon$  : dimensionless

Table 7.4 Growth model for *Lactobacillus acidophilus* CUL60 in batch fermentations

	<b>MMGM pH5.5 Uncontrolled</b>	<b>MMGM pH6.5 Uncontrolled</b>	<b>MMGM pH5.5 Controlled</b>	<b>MMGM pH6.5 Controlled</b>	<b>MRS pH5.5 Uncontrolled</b>	<b>MRS pH6.5 Uncontrolled</b>
<i>B</i>	0.5	0.65	0.5	0.5	0.8	1.0
<i>C</i>	0.015	0.013	0.02	0.02	0.005	0.005
<i>D</i>	157	127	35	57	10	8
$\varepsilon$	0	25	10	20	55	85

*B* : 1/hour; *C* : g/ml; *D* : dimensionless;  $\varepsilon$  : dimensionless

Table 7.5 Growth model for *Lactobacillus acidophillus* CUL21 in batch fermentations

	MMGM pH5.5 Uncontrolled	MMGM pH6.5 Uncontrolled	MMGM pH5.5 Controlled	MMGM pH6.5 Controlled	MRS pH5.5 Uncontrolled	MRS pH6.5 Uncontrolled
$B$	0.25	0.5	0.7	0.7	1.5	2.2
$C$	0.01	0.01	0.045	0.01	0.025	0.01
$D$	120	65	24	47	8	8
$\varepsilon$	100	100	10	100	70	100

$B$  : 1/hour;  $C$  : g/ml;  $D$  : dimensionless;  $\varepsilon$  : dimensionless

### 7.2.2 Multiple-strain batch fermentation

Extending the growth model in Eqns. (7.2-7.3) to batch culture of multiple microorganisms is straightforward. Specifically, the governing ODE system becomes

$$\frac{d\beta_i}{dt} = \frac{B_i \beta_N \beta_i}{C_i + \beta_N + \sum_{j=1}^{N-1} \varepsilon_{ij} \beta_j} \quad \text{for } i = 1, \dots, N-1 \quad (7.4)$$

$$\frac{d\beta_N}{dt} = - \sum_{i=1}^{N-1} \frac{D_i B_i \beta_N \beta_i}{C_i + \beta_N + \sum_{j=1}^{N-1} \varepsilon_{ij} \beta_j}, \quad (7.5)$$

where  $\beta_i$ ,  $i = 1, \dots, N-1$ , represents the mass concentration of microbe  $i$ ,  $B_i$  the associated maximum specific growth rate,  $C_i$  the associated velocity-delay constant,  $D_i$  the associated yield rate,  $\beta_N$  the mass concentration of substrate, and  $\varepsilon_{ij}$  the interaction coefficient from the microbe  $j$  onto the microbe  $i$ . The growth efficiency is described by  $B_i$  and  $C_i$ . Larger  $B_i$  value and smaller  $C_i$  value correspond to faster microbe growth. The growth productivity is described by  $D_i$ . Smaller  $D_i$  values correspond to higher conversion rates from nutrient to biomass. The unit for the mass concentrations  $\beta_i$ ,  $i = 1, \dots, N$  are g/ml, the unit for growth

rates  $B_i$  is 1/hour and the unit for velocity-delay constants  $C_i$  is g/ml, while the yield rates  $D_i$  and the interaction coefficients  $\varepsilon_{ij}$  are dimensionless.

*In vitro* batch fermentation experiments of multiple microorganisms were carried out using probiotic mixtures LAB4 and LAB4B, both of which contain *B. Lactis* (CUL34) and *B. bifidum* (CUL20). *B. Lactis* and *B. bifidum* are very sensitive to environmental conditions, and they did not grow well during the batch culture experiments. These unsuccessful experiments could not offer sufficient data for validation of the multiple-strain batch fermentation model in Eqns. (7.4-7.5). However, the multiple-strain batch fermentation model will be examined and validated in Section 7.3 together with the chemostat fermentation model.

### 7.3 Modelling of chemostat fermentation

A series of continuous culture experiments were also performed using a chemostat setting, as listed in Table 7.6. These experiments were designed to mimic the gut fermentation environment. Therefore, the MMGM has been adopted as the sole culture medium in all these chemostat-based fermentations. The experiments include 2 single-stage continuous fermentations and 2 two-stage continuous fermentations. Each of these experiments was run and continuously monitored for 10 days. In the rest of this section, the new growth model proposed in Eqns. (7.2-7.5) will first be extended and validated on the single-stage fermentation experiments, followed by further extended and validation on the two-stage fermentation experiments.

Table 7.6 List of chemostat fermentations conducted in this research

Continuous model <sup>1</sup>	Microorganisms	Vessel 1 pH	Vessel 2 pH
Single-stage	Mixture of gut microbes <sup>2</sup> , LAB4 <sup>3</sup>	5.5	N/A
Single-stage	Mixture of gut microbes <sup>2</sup> , LAB4B <sup>4</sup>	5.5	N/A
Two-stage	Mixture of gut microbes <sup>2</sup> , LAB4 <sup>3</sup>	5.5	6.5
Two-stage	Mixture of gut microbes <sup>2</sup> , LAB4B <sup>4</sup>	5.5	6.5

<sup>1</sup> Culture medium: MMGM; Working volume: 250 ml; Flow rate: 10.4 ml/h; Running time: 240 hrs

<sup>2</sup> Mixture of gut microbes: *E. coli* (QC1), *E. cloacae* (QC4), *E. faecalis* (QC9)

<sup>3</sup> LAB4: *L. acidophilus* (CUL60), *L. acidophilus* (CUL21), *B. Lactis* (CUL34) and *B. bifidum* (CUL20)

<sup>4</sup> LAB4B: *L. salivarius* (CUL61), *L. paracasei* (CUL08), *B. Lactis* (CUL34) and *B. bifidum* (CUL20)

### 7.3.1 Single-stage chemostat fermentation

The single-stage chemostat fermentation was conducted using a single vessel with a working volume of 250 ml. Initially, the vessel was filled with 250 ml MMGM medium at concentration 0.043 g/ml, and with the flow rate set at 0, three microorganisms (*E. coli* (QC1), *E. cloacae* (QC4), *E. faecalis* (QC9)) that are typically found in the human gut were cultured for 24 hours. Then, after inoculating a mixture of probiotic strains (either LAB4 or LAB4B) to the culture media, the flow rate was switched to 10.417 ml/h to add into the vessel a constant inflow of the same MMGM medium. The chemostat fermentation was run continuously for another 9 days. During the 240 hours fermentation period, the culture medium was regularly sampled to record the growth of microorganisms.

LAB4 comprises *L. acidophilus* (CUL60), *L. acidophilus* (CUL21), *B. Lactis* (CUL34) and *B. bifidum* (CUL20), while LAB4B comprises *L. salivarius* (CUL61), *L. paracasei* (CUL08), *B. Lactis* (CUL34) and *B. bifidum* (CUL20). The aim of these *in vitro* studies was to investigate how these two probiotic mixtures react in a gut-like environment. Hence, the pH was controlled at 5.5 to mimic the acid environment of the ascending colon.

To simulate the single-stage chemostat fermentation with a constant inflow and outflow, the multiple-strain batch fermentation model defined in Eqns. (7.4-7.5) is extended as follows:

$$\frac{d\beta_i}{dt} = \frac{B_i\beta_N\beta_i}{C_i + \beta_N + \sum_{j=1}^{N-1} \varepsilon_{ij}\beta_j} - \frac{q}{V}\beta_i \quad \text{for } i = 1, \dots, N-1 \quad (7.6)$$

$$\frac{d\beta_N}{dt} = -\sum_{i=1}^{N-1} \frac{D_i B_i \beta_N \beta_i}{C_i + \beta_N + \sum_{j=1}^{N-1} \varepsilon_{ij} \beta_j} + \frac{q}{V}(\beta_N^{IN} - \beta_N), \quad (7.7)$$

where  $q = 10.417$  ml/h denotes the constant flow rate operated in the chemostat,  $V = 250$  ml the working volume of the chemostat,  $\beta_N^{IN} = 0.043$  g/ml the mass concentration of substrate at the inflow. Other symbols in the above equations share the same definitions as in Eqns. (7.4-7.5).

#### ***Single-stage chemostat fermentation of LAB4***

The single-stage chemostat fermentation using LAB4 is first investigated here. The *in vitro* fermentation contains two steps: batch culture of the gut microbes (for 24 hours) and chemostat culture of gut microbes and probiotics LAB4 (for 9 days). The first step is simulated using the multiple-strain batch fermentation model defined in Eqns. (7.4-7.5). Specifically, the parameters  $B_i$ ,  $C_i$ ,  $D_i$  and  $\varepsilon_{ij}$  in Eqns. (7.4-7.5) are determined by approximating the batch fermentation data, and then the simulation is performed again using the optimized parameter values to show how the simulation results fit to the experimental data. Figure 7.5 shows the simulation results, and the corresponding growth model is given in Table 7.7. The second step chemostat fermentation is simulated using the single-stage chemostat fermentation model defined in Eqns. (7.6-7.7). Again, the optimal parameter values are determined through history matching. The simulation results are shown in Figure 7.6, and the corresponding growth model is given in Table 7.8. A good agreement

between the computer simulation and the *in vitro* experiment can be observed in Figure 7.5(a). As shown in Figure 7.5(b), the MMGM ran out quite quickly. This is expected because in Figure 7.5(a), all three microbes stopped growing after 6 hours. Good approximation between computer simulation and *in vitro* experiment is also observed in Figure 7.6, where three gut microorganisms (QC1, QC4, QC9) and two probiotics (CUL60&21, CUL34&20) grow together on MMGM. The simulation is performed for a longer period than the *in vitro* experiment, which confirms that the probiotic strains can remain alive in the chemostat environment. Comparing the growth models in Table 7.7 and Table 7.8, it can be seen that the activities of microbes are very complicated, and the same microorganism can behave very differently when the environmental condition or the population structure changes.

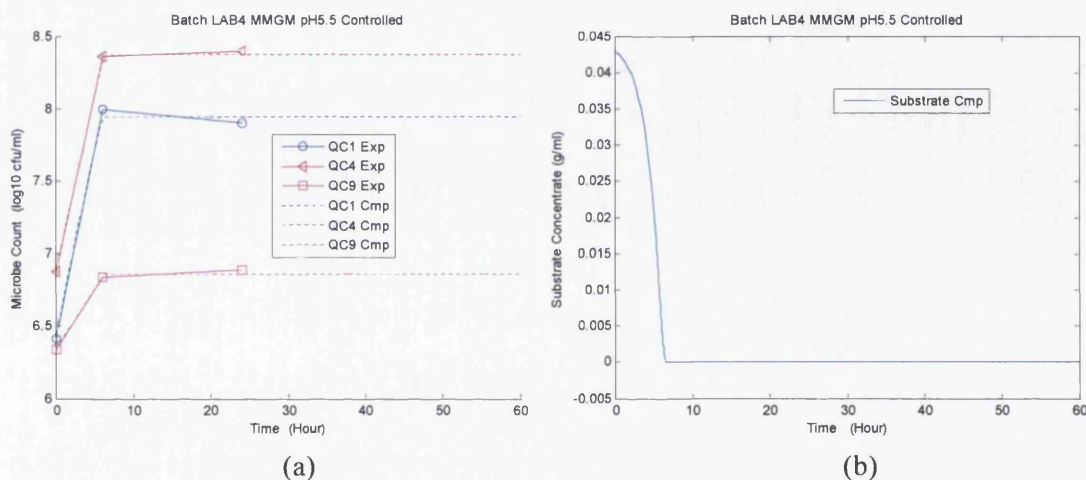

Figure 7.5 Computational modelling of the initial batch culture during the single-stage chemostat fermentation of LAB4.

Table 7.7 The growth model corresponding to Figure 7.5

	$B$	$C$	$D$	$(\varepsilon_{ij})$		
QC1	0.7708	0.0096	1.0326	0.0000	0.0000	0.0000
QC4	0.6000	0.0023	18.0465	0.0004	0.0009	0.0000
QC9	0.1976	0.0009	1.0154	0.0001	0.0002	0.0000

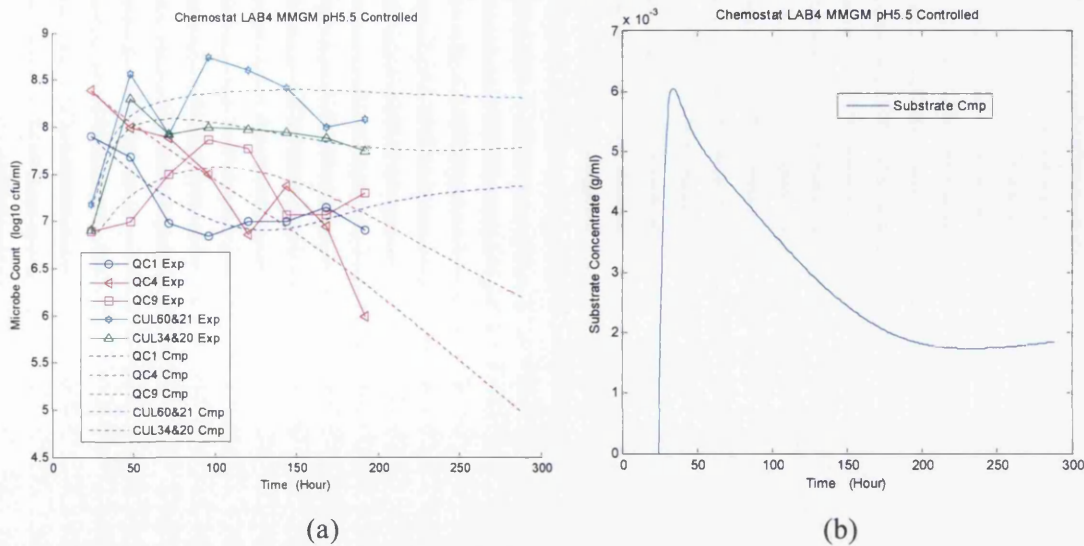

Figure 7.6 Computational modelling of the chemostat culture during the single-stage chemostat fermentation of LAB4.

Table 7.8 The growth model corresponding to Figure 7.6

	<i>B</i>	<i>C</i>	<i>D</i>	$(\epsilon_{ij})$				
QC1	2.5093	0.0144	49.8519	365.6324	999.9892	0.0024	0.3233	0.0376
QC4	2.0063	0.0750	1.0110	971.5688	243.4935	0.5441	12.5855	170.2440
QC9	1.9850	0.0102	1.0313	131.6302	1.6167	0.7436	62.0416	0.0019
CUL60&21	3.7201	0.0148	14.1635	11.1077	6.5539	0.0000	3.0880	241.9406
CUL34&20	4.9790	0.0001	1.0757	0.1130	0.8822	307.4753	0.0020	341.3134

**Single-stage chemostat fermentation of LAB4B**

The single-stage chemostat fermentation using LAB4B is similarly investigated. Figure 7.7 shows the simulation result for the first step batch fermentation, which only contains gut microbes QC1, QC4 and QC9. The growth model is given in Table 7.9. For the second step chemostat fermentation, the simulation results are plotted in Figure 7.8, and the corresponding growth model is given in Table 7.10. Again, Figures 7.7(a) and 7.8(a) show a good agreement between the simulation results and the *in vitro* experiments. The prolonged simulation confirms that the probiotic strains LAB4B can also stay alive in the chemostat environment. Note that bacteria death is

not considered in the proposed growth model, and therefore a difference is observed for QC9 growth curves in Figure 7.7(a).

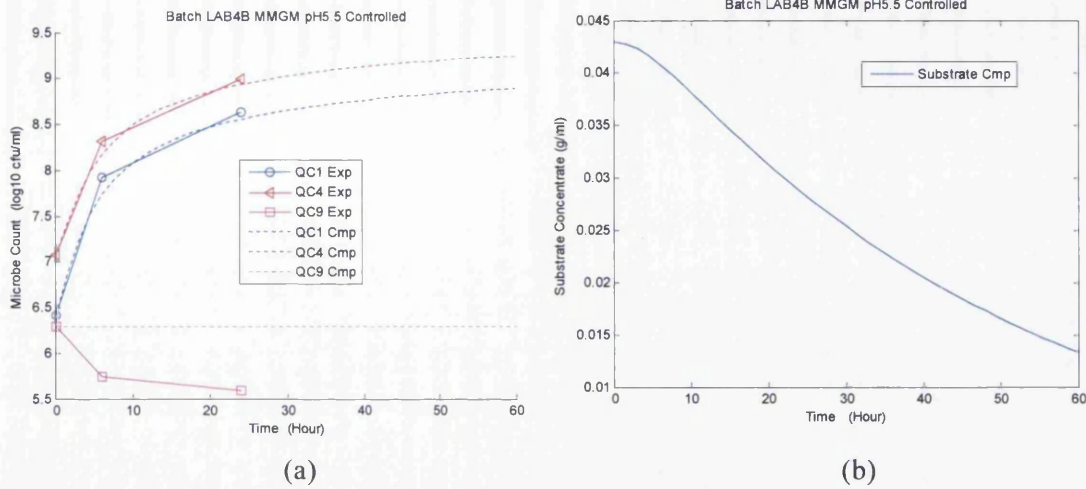

Figure 7.7 Computational modelling of the initial batch culture during the single-stage chemostat fermentation of LAB4B.

Table 7.9 The growth model corresponding to Figure 7.7

	$B$	$C$	$D$	$(\epsilon_{ij})$		
QC1	1.1585	0.0142	1.5129	93.7294	42.7131	5.2019
QC4	0.6253	0.0000	1.0001	112.5818	0.0091	0.9896
QC9	0.0000	2.0000	29.9384	999.9910	999.9913	999.9892

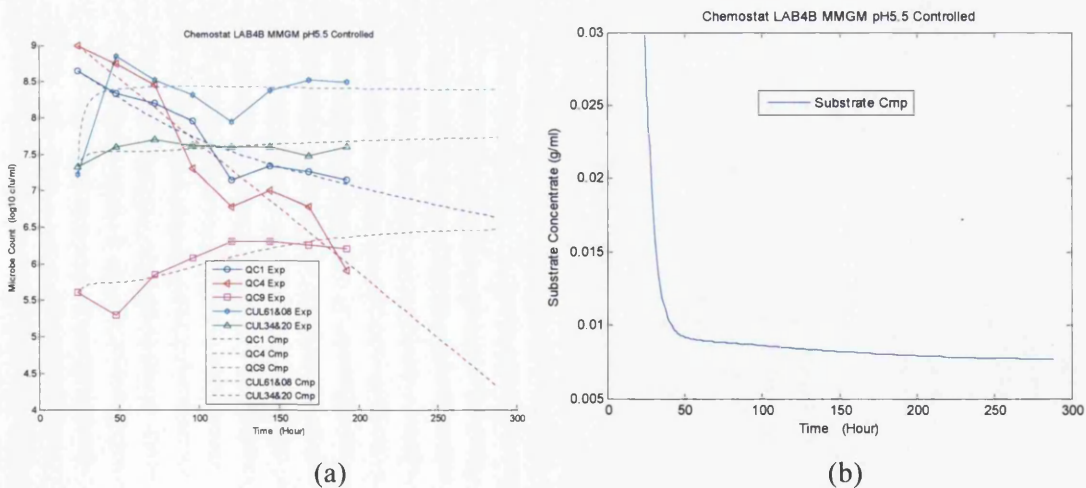

Figure 7.8 Computational modelling of the chemostat culture during the single-stage chemostat fermentation of LAB4B.



Table 7.10 The growth model corresponding to Figure 7.8

	$B$	$C$	$D$	$(\varepsilon_{ij})$				
QC1	2.6981	0.2818	1.1545	769.5034	154.9972	15.5373	134.9945	0.0243
QC4	0.4010	1.7245	1.8824	826.0380	832.5866	5.4989	630.6081	533.2154
QC9	4.2628	0.0059	48.6567	0.0109	88.5103	999.9675	81.2933	997.0603
CUL60&21	4.7092	0.0107	9.2137	0.3956	0.0308	49.0666	350.9284	0.0046
CUL34&20	4.5027	0.0518	21.3773	15.4833	60.8776	708.4021	240.3648	277.6824

### 7.3.2 Two-stage chemostat fermentation

The two-stage chemostat fermentation was performed using two connected vessels, each having a working volume of 250 ml. Initially, both vessels were filled with 250 ml MMGM of concentration 0.043 g/ml, and were inoculated with three gut microorganisms (*E. coli* (QC1), *E. cloacae* (QC4), *E. faecalis* (QC9)). The first vessel was controlled at pH 5.5 to mimic the ascending colon while the second vessel was controlled at pH 6.5 to mimic the descending colon. With the flow rate set to 0, the gut microorganisms were first cultured for 24 hours in both vessels. Then, LAB4 (or LAB4B) probiotic strains were inoculated into both vessels and at the same time, the flow rate was switched to 10.417 ml/h to deliver a constant inflow of MMGM of the same concentration. The continuous fermentation in the connected vessels was run continuously for another 9 days. During the whole 240 hours fermentation period, the culture medium was regularly sampled and tested.

To simulate the two-stage chemostat fermentation described above and other more general experiments, a uniform mathematical model that can cope with chemostat fermentation with arbitrary number of connected vessels is developed. Figure 7.9 shows a general chemostat system with  $M$  connected vessels operated at a constant flow rate  $q$ . Each vessel  $m \in \{1, \dots, M\}$  can have a different working volume  $V_m$ , and can also contain a different collection of microbial species. For the  $m$ -th vessel, different microorganisms in the vessel are distinguished by the local index

$n = 1, \dots, N_m - 1$ , the substrate is denoted by  $n = N_m$ , and their corresponding global indices are  $r = K_m + n$ , where  $K_m = \sum_{j=1}^{m-1} N_j$ .

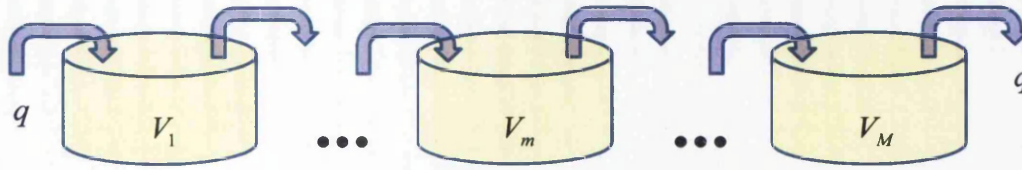

vessel	1	$m$	$M$
local ID	$n = 1, \dots, N_1$	$n = 1, \dots, N_m$	$n = 1, \dots, N_M$
global ID in Eqn	$K_1 = 0$	$K_m = \sum_{j=1}^{m-1} N_j$	$K_M = \sum_{j=1}^{M-1} N_j$
	$r = K_1 + n$	$r = K_m + n$	$r = K_M + n$

Figure 7.9 Schematic illustration of chemostat fermentation with  $M$  connected vessels

Based on the single-stage chemostat fermentation model in Eqns. (7.6-7.7), the governing equation for the general chemostat model in Figure 7.9 can be established in each vessel  $m$  as:

$$\frac{d\beta_r}{dt} = \frac{B_r \beta_{K_m + N_m} \beta_r}{C_r + \beta_{K_m + N_m} + \sum_{j=1}^{N_m-1} \varepsilon_{rs} \beta_s} + \frac{q}{V_m} (\beta_n^* - \beta_r) \quad \text{for } n = 1, \dots, N_m - 1 \quad (7.8)$$

$$\frac{d\beta_{K_m + N_m}}{dt} = - \sum_{n=1}^{N_m-1} \frac{D_n B_n \beta_{K_m + N_m} \beta_n}{C_r + \beta_{K_m + N_m} + \sum_{j=1}^{N_m-1} \varepsilon_{rs} \beta_s} + \frac{q}{V_m} (\beta_{N_m}^* - \beta_{K_m + N_m}), \quad (7.9)$$

where  $s = K_m + j$ ,  $\beta_r$  denotes the mass concentration of the  $n$ -th microbe in the vessel  $m$ ,  $B_r$  the maximum specific growth rate of the  $n$ -th microbe,  $C_r$  the velocity-delay constant of the  $n$ -th microbe,  $D_r$  the yield rate of the  $n$ -th microbe,  $\varepsilon_{rs}$  the interaction coefficient from the  $j$ -th microbe to the  $n$ -th microbe

within the vessel  $m$ ,  $\beta_{K_m+N_m}$  the mass concentration of the substrate in the vessel  $m$ ,  $\beta_n^*$  the mass concentration of the microbe in the previous vessel (i.e. the vessel  $m-1$ ) that is of the same type as the current vessel's  $n$ -th microbe,  $\beta_{N_m}^* = \beta_{K_{m-1}+N_{m-1}}$  for  $m \neq 1$  and  $\beta_{N_m}^* = 0.043$  g/ml for  $m=1$ .

### Two-stage chemostat fermentation of LAB4

The two-stage chemostat fermentation of LAB4 is first considered. For the initial batch fermentation of the gut microorganisms (QC1, QC4 and QC9), the multiple-strain batch fermentation model defined in Eqns. (7.4-7.5) is used, and the optimal values for parameters  $B_i$ ,  $C_i$ ,  $D_i$  and  $\varepsilon_{ij}$  are determined by approximating the growth data from the batch fermentation experiment. The simulation results for vessel 1 are plotted in Figure 7.10, and the corresponding growth model is given in Table 7.11. The simulation results for vessel 2 are plotted in Figure 7.11, and the corresponding growth model is given in Table 7.12. Both growth curves in Figure 7.10(a) and Figure 7.11(a) show a good agreement between the simulation and the experimental data. Figure 7.10(b) and Figure 7.11(b) show respectively the changes of substrates in vessel 1 and vessel 2, which will feed into the simulation for the second-step chemostat fermentation.

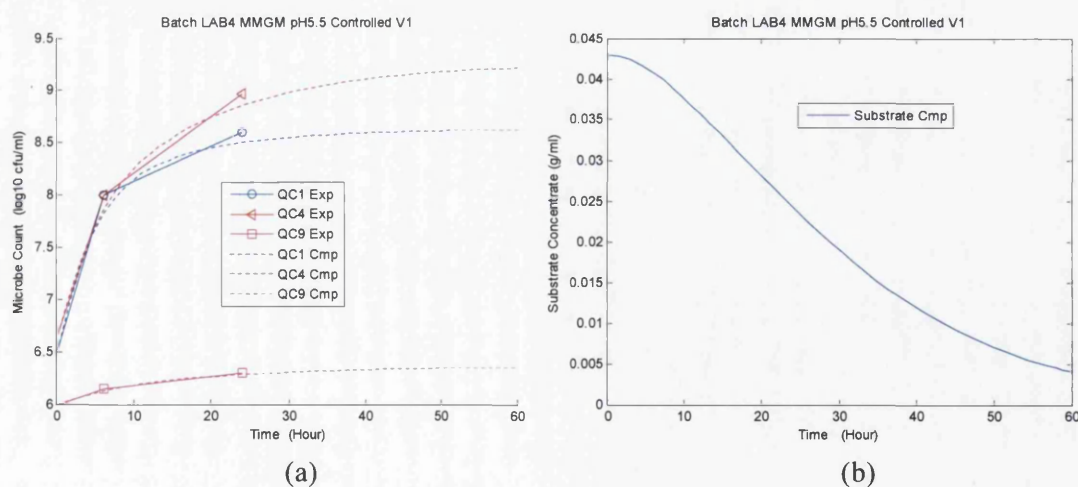

Figure 7.10 Computational modelling of the initial batch culture during the two-stage chemostat fermentation of LAB4, vessel 1.

Table 7.11 The growth model corresponding to Figure 7.10

	$B$	$C$	$D$	$(\epsilon_{ij})$		
QC1	0.9612	0.0074	1.3751	5.8992	124.9120	0.0053
QC4	0.6344	0.0006	1.9862	59.4466	7.6396	0.0001
QC9	0.1467	0.0652	1.3137	64.6401	5.8659	58.1393

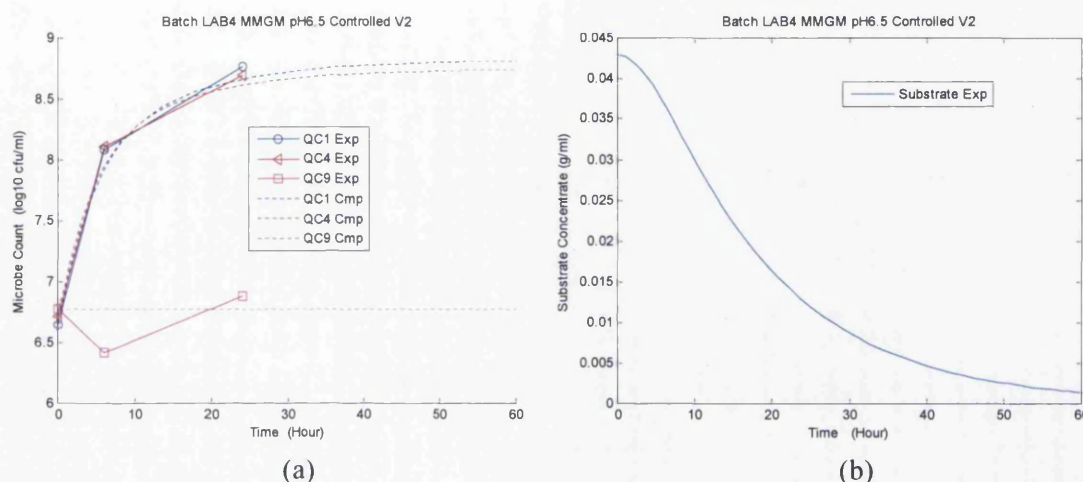

Figure 7.11 Computational modelling of the initial batch culture during the two-stage chemostat fermentation of LAB4, vessel 2.

Table 7.12 The growth model corresponding to Figure 7.11

	$B$	$C$	$D$	$(\epsilon_{ij})$		
QC1	0.8072	0.0055	1.7751	61.1230	13.4653	0.1179
QC4	0.7193	0.0000	5.4996	75.4874	1.9233	1.8412
QC9	0.0000	2.0000	4.6674	999.8134	999.8452	999.9997

The second-step chemostat fermentation is simulated using the model defined in Eqns. (7.8-7.9), whose optimal parameters are determined through history matching with the *in vitro* chemostat fermentation data. The results for vessel 1 are plotted in Figure 7.12, and the corresponding growth model is given in Table 7.13. The results for vessel 2 are plotted in Figure 7.13, and the corresponding growth model is given in Table 7.14. It can be seen from Figure 7.12(a) and Figure 7.13(a) that good agreement for the growth histories is achieved for both vessel 1 and vessel 2. The

simulation is performed for 360 hours, which confirms that LAB4 probiotic strains can remain stable in the simulated gut environment for a longer period. Comparing the growth models in Table 7.13 and Table 7.14, it can be observed that the maximum specific growth rates  $B_i$  generally dropped from vessel 1 to vessel 2, the velocity-delay constants  $C_i$  increased, and the yield rates  $D_i$  increased as well. All of these indicate that the microbial growth in vessel 1 is more active and more productive than vessel 2, despite its higher pH value.

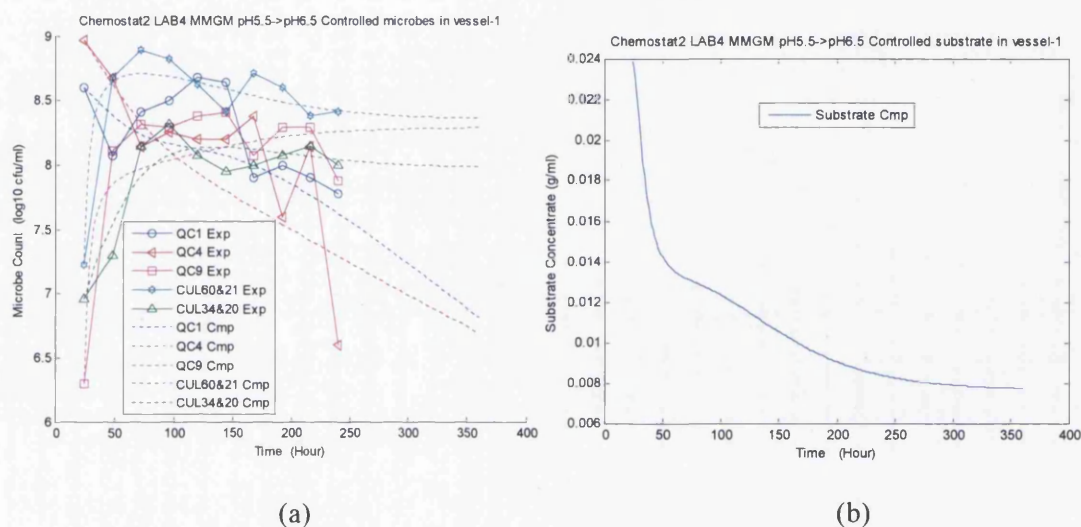

Figure 7.12 Computational modelling of the chemostat culture during the two-stage chemostat fermentation of LAB4, vessel 1.

Table 7.13 The growth model corresponding to Figure 7.12

	$B$	$C$	$D$		$(\epsilon_{ij})$			
QC1	2.2266	0.0000	1.0001	0.1134	266.8761	311.7281	0.0806	40.2105
QC4	3.3634	0.0000	3.3311	0.6152	998.7156	364.3487	17.0817	25.6989
QC9	4.7218	0.0001	15.5450	2.7920	6.1136	191.7519	201.6215	20.5157
CUL60&21	3.0654	0.0004	1.4597	5.1234	0.5552	4.8979	145.1772	225.8366
CUL34&20	2.6617	0.0001	1.1073	0.9760	57.0839	29.4460	0.0086	441.9062

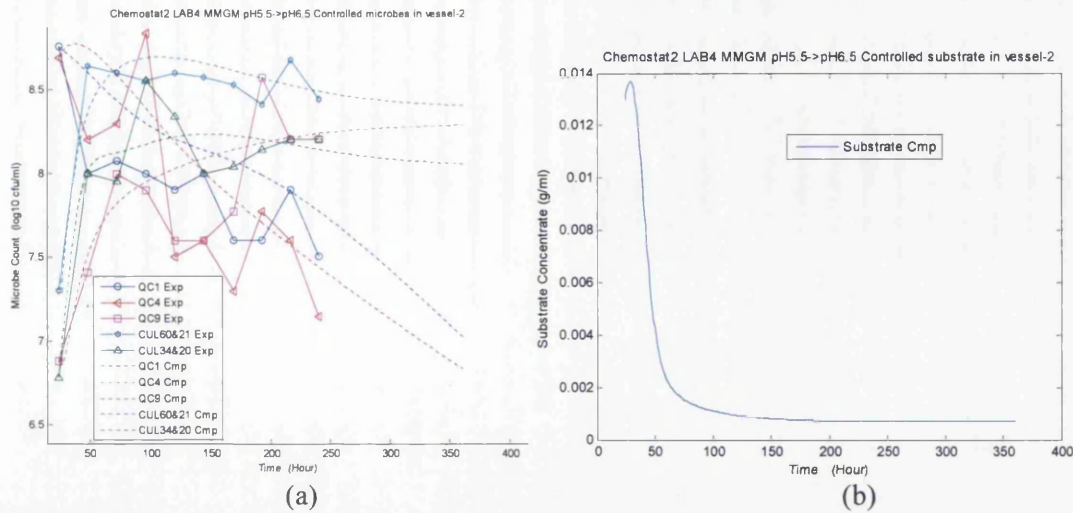

Figure 7.13 Computational modelling of the chemostat culture during the two-stage chemostat fermentation of LAB4, vessel 2.

Table 7.14 The growth model corresponding to Figure 7.13

	$B$	$C$	$D$	$(\epsilon_{ij})$				
QC1	0.0026	1.2983	2.7645	440.3544	525.9277	370.3374	391.7867	360.5794
QC4	0.0100	1.8877	3.5455	918.8279	924.4341	968.3675	406.3729	973.5825
QC9	0.1556	1.3705	46.5474	774.1974	723.4212	602.7597	429.8577	783.7700
CUL60&21	2.0465	0.2071	31.8893	2.8713	116.5025	25.1375	56.6308	0.0078
CUL34&20	3.4988	0.0143	1.1128	44.1394	0.0025	213.7069	0.0026	0.1763

### ***Two-stage chemostat fermentation of LAB4B***

The two-stage chemostat fermentation of LAB4B is similarly investigated. The initial batch fermentation for QC1, QC4 and QC9 are approximated using the multiple-strain batch fermentation model defined in Eqns. (7.4-7.5). The simulation results for vessel 1 are plotted in Figure 7.14, and the corresponding growth model is given in Table 7.15. The simulation results for vessel 2 are plotted in Figure 7.15, and the corresponding growth model is given in Table 7.16. The QC9 curves in Figure 7.14(a) and Figure 7.15(a) show a difference between the simulation and the *in vitro* data. This is because the current model only considers the growth of bacteria,

and the death is not modelled. However, this does not affect the simulation for chemostat fermentation where microbe death is negligible.

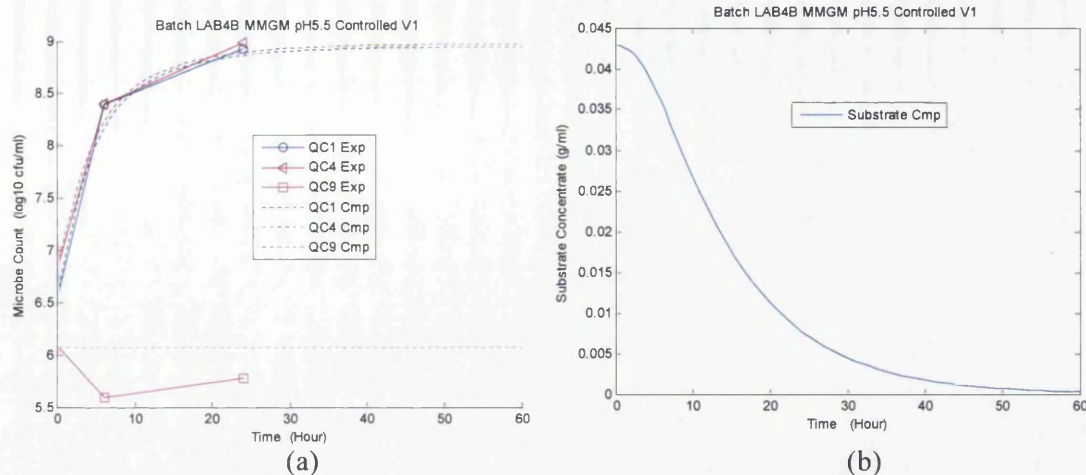

Figure 7.14 Computational modelling of the initial batch culture during the two-stage chemostat fermentation of LAB4B, vessel 1.

Table 7.15 The growth model corresponding to Figure 7.14

	$B$	$C$	$D$		$(\epsilon_{ij})$	
QC1	1.2265	0.0170	3.3648	55.6959	0.0001	5.1047
QC4	0.7530	0.0021	1.6911	34.9202	0.0000	1.0455
QC9	0.0000	2.0000	29.9384	999.9910	999.9913	999.9892

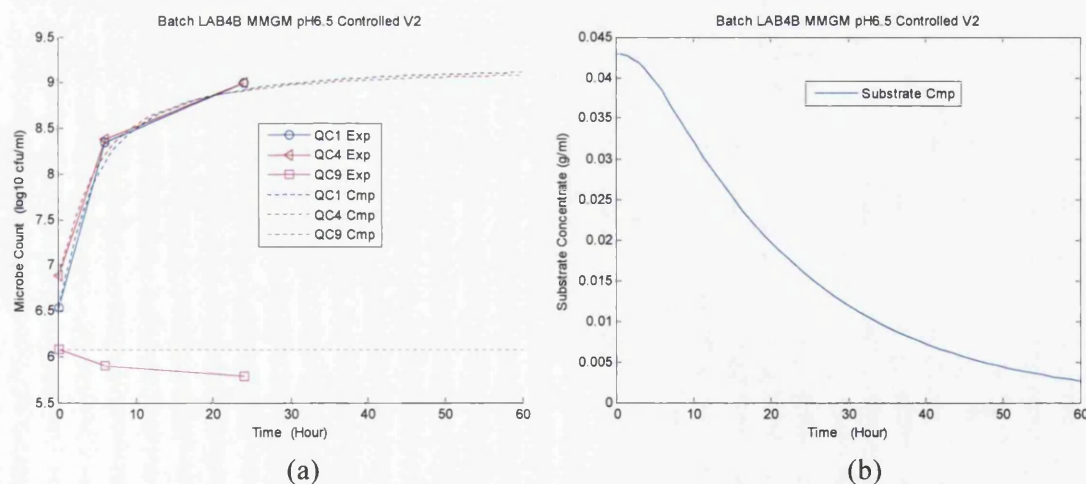

Figure 7.15 Computational modelling of the initial batch culture during the two-stage chemostat fermentation of LAB4B, vessel 2.

Table 7.16 The growth model corresponding to Figure 7.15

	$B$	$C$	$D$	$(\epsilon_{ij})$		
QC1	3.1606	0.1136	1.0013	156.1207	0.0003	6.4608
QC4	2.5749	0.1125	2.7299	141.5258	0.0027	70.6244
QC9	0.0000	2.0000	7.8227	1000.0000	999.9954	999.8780

For the second-step chemostat fermentation, the simulation results are plotted in Figure 7.16 for vessel 1 and Figure 7.17 for vessel 2. For both vessels and all five microorganisms, good agreement is achieved between the simulation and the *in vitro* experiment. The simulation confirms that LAB4B probiotic strains can stay alive for a longer period, with CUL61&08 performing better than CUL34&20. Comparing the two growth models in Table 7.17 and Table 7.18, it can be seen that the growth efficiency (described by  $B_i$  and  $C_i$ ) for QC1 improved from vessel 1 to vessel 2, the growth efficiency for QC4 dropped, and the growth efficiencies for QC9, CUL61&08 and CUL34&20 remained stable. However, described by the parameter  $D_i$ , the productivity of QC1, QC4 and CUL34&20 dropped from vessel 1 to vessel 2, the productivity of QC9 improved, and the productivity of CUL61&08 remained stable. Overall, for LAB4B, the difference in terms of growth activity between vessel 1 and vessel 2 is not as significant as LAB4. This may indicate that LAB4B is more tolerant to nutrient concentration but more sensitive to the pH condition, while LAB4 is more tolerant to pH condition but more sensitive to nutrient concentration.



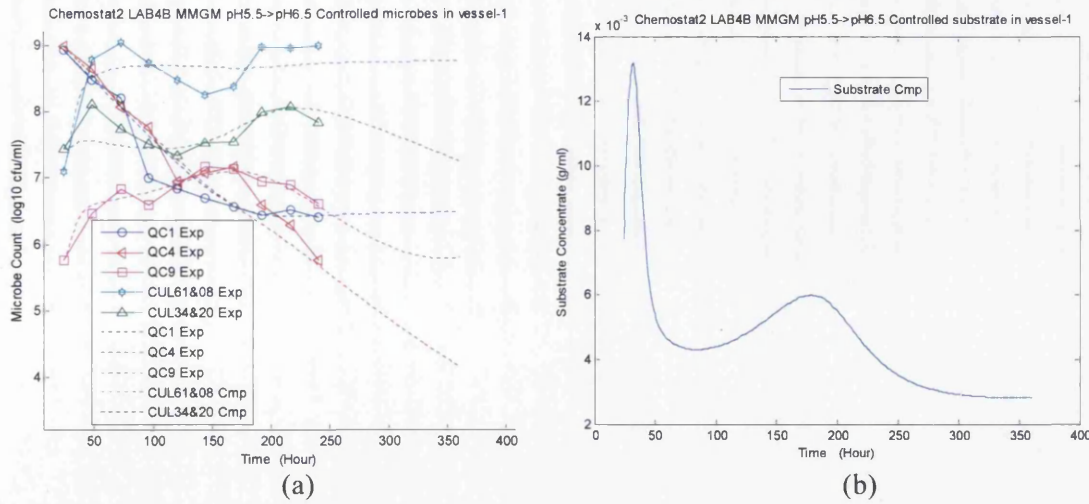

Figure 7.16 Computational modelling of the chemostat culture during the two-stage chemostat fermentation of LAB4B, vessel 1.

Table 7.17 The growth model corresponding to Figure 7.16

	<i>B</i>	<i>C</i>	<i>D</i>	$(\epsilon_{ij})$				
QC1	0.2144	0.0000	1.0001	365.3467	955.2005	0.0004	0.0230	0.0028
QC4	0.2579	0.0001	16.3991	999.9998	906.7089	0.0001	0.0118	55.8880
QC9	4.9987	0.0002	35.9326	0.0531	5.9478	561.5483	18.0402	999.8233
CUL61&08	1.2289	0.0078	6.8060	3.2450	0.1877	850.3422	11.4753	0.0163
CUL34&20	2.4495	0.0002	1.0564	27.4268	34.1825	0.9013	45.8434	18.4661

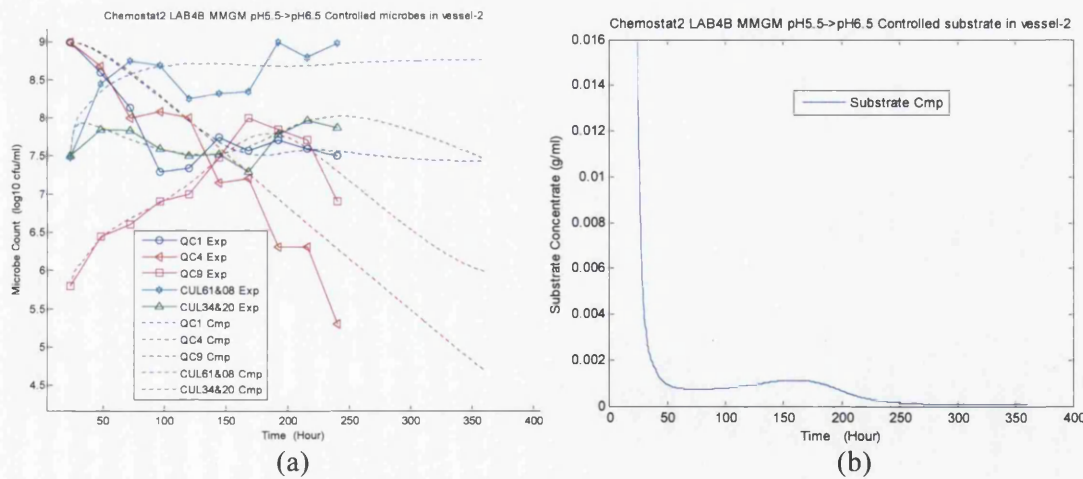

Figure 7.17 Computational modelling of the chemostat culture during the two-stage chemostat fermentation of LAB4B, vessel 2.

Table 7.18 The growth model corresponding to Figure 7.17

	<i>B</i>	<i>C</i>	<i>D</i>	$(\varepsilon_{ij})$					
QC1	4.8166	0.0000	10.5178	8.0387	933.1889	0.5070	0.6065	0.0025	
QC4	0.0024	1.9810	49.9990	858.6434	802.3901	995.6263	994.8830	991.2607	
QC9	4.9997	0.0026	2.0451	27.7543	0.0136	31.2625	0.7044	185.9525	
CUL61&08	0.8107	0.0000	5.0374	0.0384	0.0000	963.5968	17.5485	0.0001	
CUL34&20	4.9492	0.0212	8.9034	1.7567	0.0001	981.2848	302.5761	10.6220	

### 7.3.3 Prediction of a three-stage chemostat fermentation

To demonstrate how the computational model can help to scale up the study from the component-level to the system-level, a three-stage chemostat fermentation is simulated using the general chemostat fermentation model defined in Eqns. (7.8-7.9). The first two vessels are set at the same condition as the two-stage chemostat fermentation of LAB4B described in Section 7.3.2, and the last vessel is set at the same condition as the second vessel. Thus, vessel 1, vessel 2 and vessel 3 are set respectively at pH 5.5, pH6.5 and pH6.5, and sequentially they mimic the ascending colon, the transverse colon and the descending colon. The simulation results are plotted in Figure 18, Figure 19 and Figure 20 respectively. From the growth history, it can be seen that the global patterns of all five microorganisms are similar in the three vessels, and differences are mainly observed for the period when the microbial populations are changing rapidly. The biomass concentrations of all five microbes increase from vessel 1 to vessel 3. As shown in the substrate plots, the fermentation activity becomes more stable from vessel 1 to vessel 3. The conclusions made on simulation results should be treated with care, because their reliability largely depends on the reliability of the validation data set. However, they do provide a useful reference when planning new *in vivo* or *in vitro* tests.

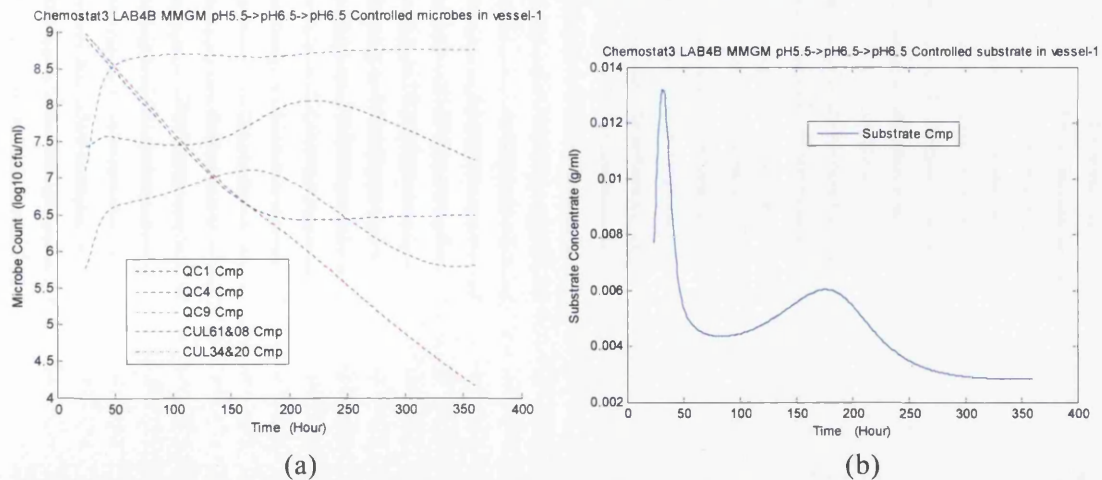

Figure 7.18 Computational modelling of a three-stage chemostat fermentation of LAB4B, vessel 1.

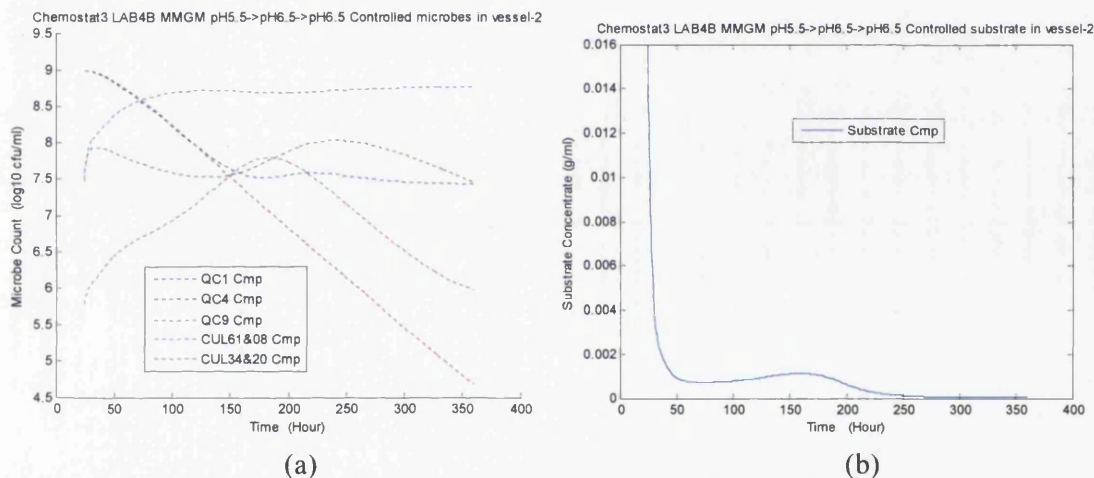

Figure 7.19 Computational modelling of a three-stage chemostat fermentation of LAB4B, vessel 2.

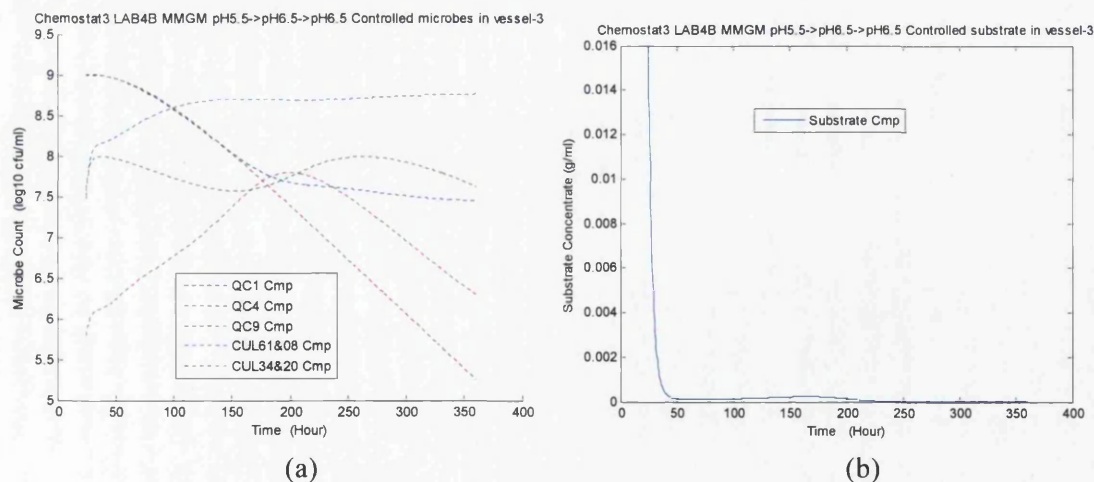

Figure 7.20 Computational modelling of a three-stage chemostat fermentation of LAB4B, vessel 3.

## 7.4 A theoretical analysis on steady-state coexistence of microorganisms

This section provides a theoretical analysis to show how the new growth model proposed in Eqns. (7.2-7.9) can overcome the paradox of competitive exclusion predicted by previous microbial competition theories. Without loss of generality, a single-stage chemostat with one substrate and two microorganisms is considered here.

Following the classic microbial competition theory (Hansen et al. 1980), the governing equation for the system is

$$\frac{d\beta_1}{dt} = \frac{B_1\beta_3\beta_1}{C_1 + \beta_3} - \frac{q}{V}\beta_1 \quad (7.10)$$

$$\frac{d\beta_2}{dt} = \frac{B_2\beta_3\beta_2}{C_2 + \beta_3} - \frac{q}{V}\beta_2 \quad (7.11)$$

$$\frac{d\beta_3}{dt} = -\frac{D_1B_1\beta_3\beta_1}{C_1 + \beta_3} - \frac{D_2B_2\beta_3\beta_2}{C_2 + \beta_3} + \frac{q}{V}(\beta_3^{IN} - \beta_3), \quad (7.12)$$

where  $\beta_1$  and  $\beta_2$  denote the mass concentrations of the two microbes 1 and 2 respectively,  $\beta_3$  the mass concentration of the limiting substrate.

When a steady state is reached, the time derivatives in Eqns. (7.10-7.12) vanish and lead to

$$\frac{B_1\beta_3}{C_1 + \beta_3} - \frac{q}{V} = 0 \quad (7.13)$$

$$\frac{B_2\beta_3}{C_2 + \beta_3} - \frac{q}{V} = 0 \quad (7.14)$$

$$-\frac{D_1 B_1 \beta_3 \beta_1}{C_1 + \beta_3} - \frac{D_2 B_2 \beta_3 \beta_2}{C_2 + \beta_3} + \frac{q}{V} (\beta_3^{IN} - \beta_3) = 0. \quad (7.15)$$

The solutions to Eqns. (7.13-7.14) are

$$\beta_3 = \frac{q C_1}{B_1 V - q}, \quad (7.16)$$

$$\beta_3 = \frac{q C_2}{B_2 V - q}. \quad (7.17)$$

The above solutions cannot hold simultaneously unless the growth rates of the two microbial species intersect with each other, as shown in Figure 7.21 where the growth rates of microbe 1 and microbe 2 intersect at the green point. But even in this case, the coexistence is not stable. If the substrate concentration is slightly larger than the intersection concentration marked by the green point, microbe 1 (marked in red) will eliminate microbe 2 (marked in blue) from the chemostat. If the substrate concentration is slightly smaller than the interaction concentration, microbe 2 will eliminate microbe 1 from the chemostat. Hence, according to the classic Monod growth model, stable coexistence cannot happen, which is in direct contradiction to common knowledge of real-world microbial communities.

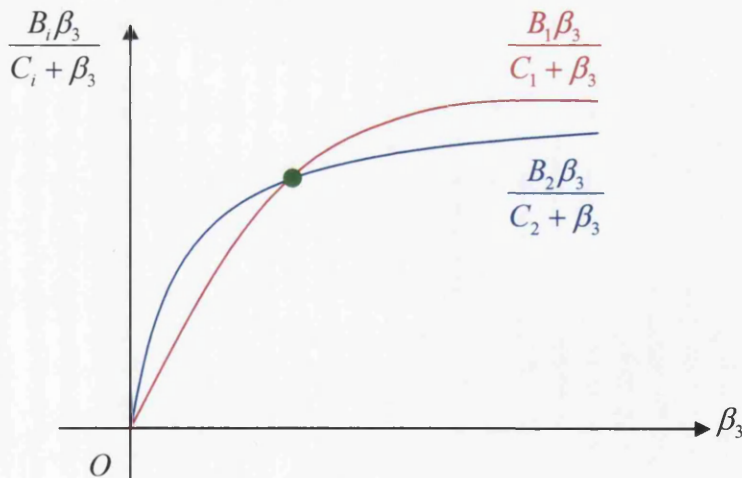

Figure 7.21 Illustration of the growth rate

All previous research works in mathematical / computational modelling of gut microbiota have been based on the classic Monod model. The prediction of competitive exclusion is fundamentally wrong, knowing that the gut microbiota for healthy adults is very stable with hundreds of microbial species living together happily in the GI tract. There have been some modifications, such as infinite diversity of nutrients, wall attachment and random motility etc. But these external factors do not resolve the intrinsic character of competitive exclusion in the Monod model, and in essence coexistence is still a rare possibility in these modified models.

Based on the proposed growth model, the governing equation of the chemostat with one substrate and two microorganisms is

$$\frac{d\beta_1}{dt} = \frac{B_1\beta_3\beta_1}{C_1 + \beta_3 + \varepsilon_{11}\beta_1 + \varepsilon_{12}\beta_2} - \frac{q}{V}\beta_1, \quad (7.18)$$

$$\frac{d\beta_2}{dt} = \frac{B_2\beta_3\beta_2}{C_2 + \beta_3 + \varepsilon_{21}\beta_1 + \varepsilon_{22}\beta_2} - \frac{q}{V}\beta_2, \quad (7.19)$$

$$\frac{d\beta_3}{dt} = -\frac{D_1B_1\beta_3\beta_1}{C_1 + \beta_3 + \varepsilon_{11}\beta_1 + \varepsilon_{12}\beta_2} - \frac{D_2B_2\beta_3\beta_2}{C_2 + \beta_3 + \varepsilon_{21}\beta_1 + \varepsilon_{22}\beta_2} + \frac{q}{V}(\beta_3^{IN} - \beta_3). \quad (7.20)$$

At the steady state, the above equations simplify to

$$\frac{B_1\beta_3}{C_1 + \beta_3 + \varepsilon_{11}\beta_1 + \varepsilon_{12}\beta_2} - \frac{q}{V} = 0, \quad (7.21)$$

$$\frac{B_2\beta_3}{C_2 + \beta_3 + \varepsilon_{21}\beta_1 + \varepsilon_{22}\beta_2} - \frac{q}{V} = 0, \quad (7.22)$$

$$-\frac{D_1B_1\beta_3\beta_1}{C_1 + \beta_3 + \varepsilon_{11}\beta_1 + \varepsilon_{12}\beta_2} - \frac{D_2B_2\beta_3\beta_2}{C_2 + \beta_3 + \varepsilon_{21}\beta_1 + \varepsilon_{22}\beta_2} + \frac{q}{V}(\beta_3^{IN} - \beta_3) = 0. \quad (7.23)$$

The solutions to Eqns. (7.21-7.22) are

$$\begin{pmatrix} \beta_1 \\ \beta_2 \end{pmatrix} = \frac{1}{q} \begin{pmatrix} \varepsilon_{11} & \varepsilon_{12} \\ \varepsilon_{21} & \varepsilon_{22} \end{pmatrix}^{-1} \begin{pmatrix} VB_1\beta_3 - qC_1 - q\beta_3 \\ VB_2\beta_3 - qC_2 - q\beta_3 \end{pmatrix}. \quad (7.24)$$

Substituting Eqn. (7.24) into Eqn. (7.23), the solution of  $\beta_3$  can be readily obtained.

With appropriate growth parameters  $B_i$ ,  $C_i$ ,  $D_i$  and  $\varepsilon_{ij}$ , the above steady-state solution always exists, and the coexistence solution is also stable. Hence, the new growth model intrinsically supports steady-state coexistence. It should be noted that, the Monod model is a special case of the new model with  $\varepsilon_{ij} = 0$ . Under the new model, microbial coexistence is a common phenomenon, while the exclusion becomes a relatively rare possibility.

## 7.5 Conclusion

In this Chapter, a new microbial growth model is proposed. The new model is a natural extension of the classic Monod model, by taking into account the various interactions between microorganisms. However, unlike the Monod model that leads to the paradox of competitive exclusion, the new model intrinsically supports steady-state coexistence of microorganisms. Based on the new growth model, a versatile simulation platform for batch and chemostat fermentations is developed. The simulation platform is extensively validated against the *in vitro* experiments described in Chapter 4 and Chapter 5. The benefits from mathematical / computational modelling are multi-dimensional. In particular it has been demonstrated how the computer simulation can help to better interpret experimental results and how the computer simulation can predict at the system level the gut microbiota based on the knowledge gained at the component level.

The new microbial growth model and the computational platform for *in vitro* fermentation experiments presented in this Chapter lays the foundation to develop a full mathematical / computational model for the human gut and the gut microbial ecosystem.

# Chapter 8 An Integrated Model of the Human Gut and Gut Microbial Ecosystem

## Abstract

This Chapter presents a comprehensive mathematical model for the human gut and the gut microbial ecosystem. The new model correctly recognizes the fluid flow in the gut as Stokes flow, takes into account the deformation of the gut and its dynamic interaction with the gut media flow, and captures the anaerobic fermentation performed by various colonic microorganisms. The model is derived from reliable knowledge of the human gut and gut microbiota, principles in physics (mass and momentum conservations), rigorous mathematical formulations, and appropriate approximations. To the best of our knowledge, this is the first mathematical model that represents the anatomy, physiology and metabolism of the human gut and gut microbial ecosystem as one uniform system. This comprehensive mathematical model provides a solid and versatile foundation for further numerical studies of the human gut and gut microbiota.



## 8.1 Introduction

### 8.1.1 Aim and motivation

After the development of the mathematical model and computational platform for *in vitro* fermentation, the objective of this part of the project was to build a relatively comprehensive mathematical model for the human gut and the gut microbial ecosystem. It is believed that a better system-level understanding of the human gut and its relation to human health and disease is mostly likely to be achieved by studying the anatomy, physiology and metabolism simultaneously in an integrated system, rather than treating them separately as isolated functional modules.

In principle, *in vivo* studies are the ideal approach to investigate the human gut as a whole system. But due to technical and ethical restrictions, it is often hard, if not impossible, to monitor closely in-situ microbial activities and interactions with the host. Hence, animal trials have been widely pursued. However, care must be taken to interpret the results from animal trials, because animal guts (rat, pig and chicken etc.) are known to have very different anatomy, physiology and metabolism compared to the human gut.

*In vitro* experiments provide an alternative platform to study the human gut under controlled environments. The main limitation for *in vitro* experiments comes from their limited complexity. Up to now, all *in vitro* gut simulators have used rigid vessels to simulate the soft and deformable GI tract, which completely ignores the physical interaction between the gut and gut media. Most *in vitro* gut simulators are based on chemostat cultures which largely ignores the heterogeneous pattern of gut medial flow and the absorption function in the gut. Finally, but more importantly, it is estimated that at least 80% bacterial species in the gut cannot be cultured with known culture media.

The potential of mathematical modelling in the study of the human gut and gut microbial ecosystem has long been recognized. In particular, compared with *in vivo*

---

and *in vitro* approaches, it is expected that mathematical modelling will be a better tool for system-level (in contrast to component-level) study of the human gut and gut microbiota. However, progress in this research direction has been very limited. A critical review on mathematical / computational modelling of the human gut is given in Chapter 2. In Section 8.1.2, some limitations and defects identified in previous mathematical models are discussed in more detail, so that the development of the new model can be better oriented.

### **8.1.2 Limitations and defects of previous mathematical / computational gut models**

Like any other human tissue, the gut wall is soft and deformable to allow large food particles to pass through the GI tract more easily and to provide temporary storage space between excretions. However, all previous mathematical / computational gut models have modelled the gut as a rigid vessel. Most models (Freter 1983d; Coleman et al. 1996; Stemmons et al. 2000; Ballyk et al. 2001; Jong et al. 2007; Munoz-Tamayo et al. 2010, 2011; Lawson et al. 2011) treated the gut as a chemostat (i.e. a rigid container with small inlet and outlet as shown in Figure 8.1(a)). In this case, the velocity of gut media flow is practically zero and a perfect mixing state has to be assumed, which completely ignores the heterogeneous flow pattern in the GI tract. As the chemostat is rigid with a constant volume, it cannot simulate periodic excretion, diarrhoea or constipation, which are perhaps the most common clinical conditions related to the gut. Several models (Kung et al. (1992); Ballyk et al. (1998, 1999, 2001); Jones et al. (2000, 2002); Wilkinson (2002a, 2002b, 2002c)) have treated the gut as a plug flow reactor (i.e. a rigid tube as shown in Figure 8.1(b)). In this case, the velocity of gut media flow is a constant, which again does not allow any spatial variation along the GI tract and cannot capture such common clinical conditions as diarrhoea and constipation.

Another fundamental aspect of the human gut that has been largely missed out by previous mathematical / computational models is what drives the gut media flow and how it is varied. In the chemostat model (Figure 8.1(a)), small inlet and outlet are

---

connected to the container, inside which the flow velocity is assumed as zero and gut media are assumed to be perfectly mixed at all time. In the plug flow model (Figure 8.1(b)), a small constant flow rate is assumed for the whole tube and at all time. Neither of these two models simulates the real gut media flow, which varies depending on time and spatial location in the GI tract. To make gut media move along the GI tract, a few researchers ((Kung et al. (1992); Ballyk et al. (1998, 1999, 2001); Jones et al. (2002); Wilkinson (2002a, 2002b, 2002c)) have invented a diffusion effect. That is, the movement of gut media is driven by the concentration gradient. However, due to the high viscosity of gut media, the diffusion effect is negligible in practice.

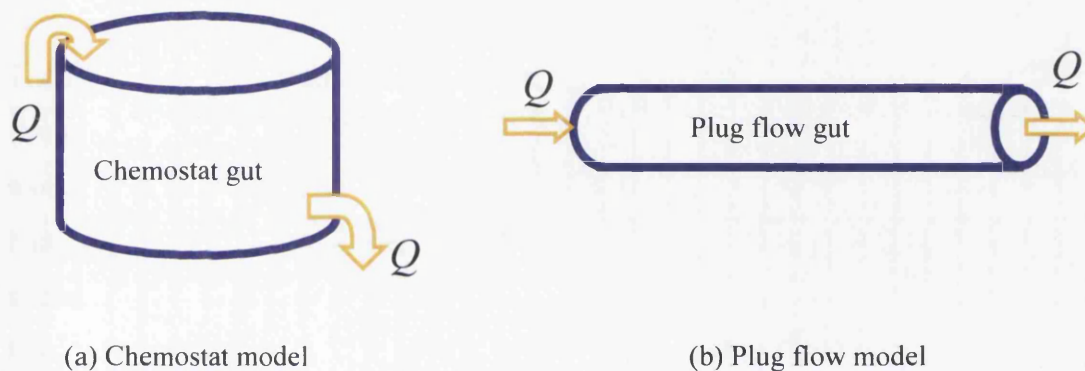

Figure 8.1 Gut models in the literature, where  $Q$  denotes the constant flow rate.

Gut media is a mixture of food particles, biomass, water and gas. It is clinically well known that the composition and physical property of gut media varies significantly along the GI tract. As gut media moves through the proximal colon, the transverse colon and the distal colon, the concentration of water gradually reduces, the concentration of short chain fatty acid first increases and then decreases, and the concentration of biomass increases. The composition difference leads to varying physical properties of gut media along the GI tract, such as changing density and viscosity. Disturbance to the normal heterogeneity of gut media causes clinical conditions such as diarrhoea and constipation. However, up to now, the multiphase nature of gut media has never been recognized in any previous mathematical / computational model.

Finally, it is well known that hundreds of microbial species inhabit the gut of healthy adults and form a stable gut microbial ecosystem. It is this stable and diverse gut microbiota community that perform key metabolic functions, protect the host from pathogen invasion, and stimulate and modulate the immune system. However, all previous mathematical / computational gut models have described the microbe growth using the classic Monod model, which leads to competitive exclusion. Based on these fermentation models, only one bacterial species can remain alive at a steady state, which is obviously not true for the real gut microbial ecosystem.

### 8.1.3 The structure of a comprehensive mathematical for the human gut and gut microbiota

The new mathematical model for human gut and gut microbial ecosystem is aimed at overcoming all aforementioned limitations and defects. It is expected that the new model will serve as a solid and flexible foundation for future numerical studies of human gut and gut microbiota. The development of the new gut model can be addressed through four distinct but inter-related functional modules, as shown in Figure 8.2.

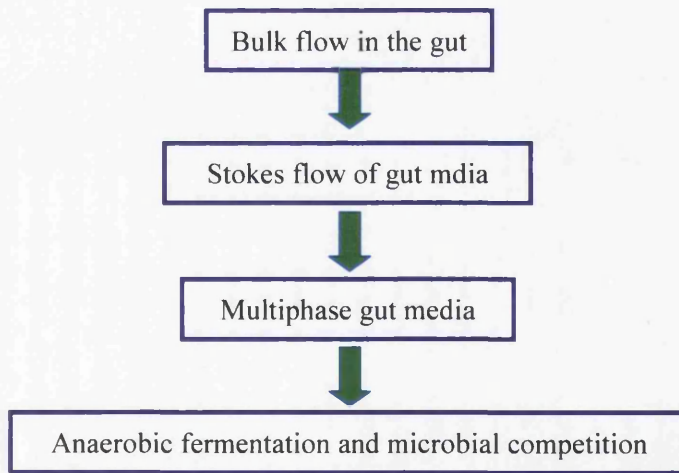

Figure 8.2 The structure of a comprehensive mathematical model for the human gut and gut microbial ecosystem

The first module aims to appropriately model the interaction between the gut and gut media such that the bulk flow in the gut can be correctly captured. The second module recognizes the low Reynolds number of the gut media flow, and based on this the governing equations can be significantly simplified. The third module generalizes the bulk flow model to distinguish between the multiple components and phases in gut media, which is essential to capture various clinical conditions and to correctly represent the gut environment where various microbial metabolic activities take place. The last module deals with the anaerobic metabolic activities of bacteria, within the gut flow environment specified through the first three modules. Details of these four modules are addressed in Sections 8.2-8.5, respectively.

## 8.2 Bulk flow in the gut

### 8.2.1 Anatomy of gut and the new gut model

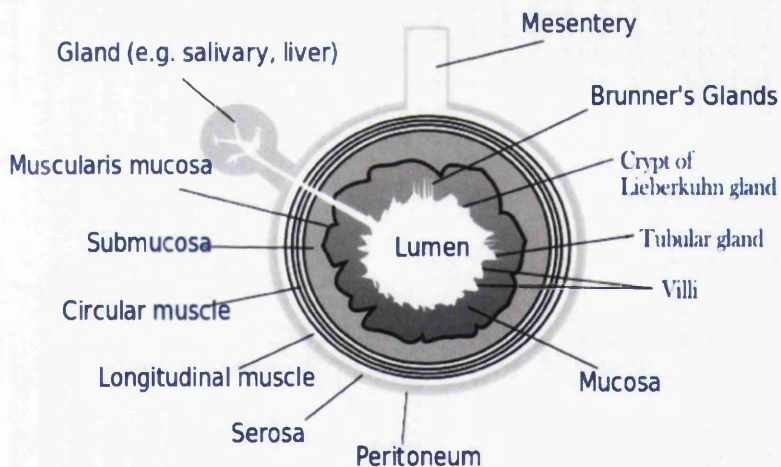

Figure 8.3 The general structure of the intestinal wall (source from Wikipedia)

The human colon has a cylindrical shape, and is approximately 150 cm in length and 6 cm in diameter. It contains three connected sections: the proximal colon (around 20 cm in length), the transverse colon (around 50 cm in length) and the distal colon (around 80 cm in length). As shown in Figure 8.3, the colon is supported by a circular muscle and longitudinal muscles, which allow the colon to deform, contract and expand.

---

To correctly reflect the anatomy of the colon and its deformable nature, it is proposed to represent the colon by an elastic tube. As the length of the colon is significantly larger than its diameter (25 times longer), it is reasonable to adopt a one-dimensional model to reduce the complexity of mathematical modelling. The new gut model is shown in Figure 8.4, where  $x$  denotes the location along the GI tract,  $t$  time,  $u(x,t)$  the bulk velocity of gut media flow and  $A(x,t)$  the cross section area. That is, the gut is represented as a one-dimensional rotationally-symmetric elastic tube. Gut media flow through the lumen and depending on its pressure, the gut wall contracts or expands, leading to changes of the cross section area. The flow in the lumen must obey the conservation laws, and the interaction between the wall and the flow must satisfy the equilibrium relation. All of these form the basic governing equations of gut media flow, which are addressed separately in Section 8.2.2, Section 8.2.3 and Section 8.2.4.

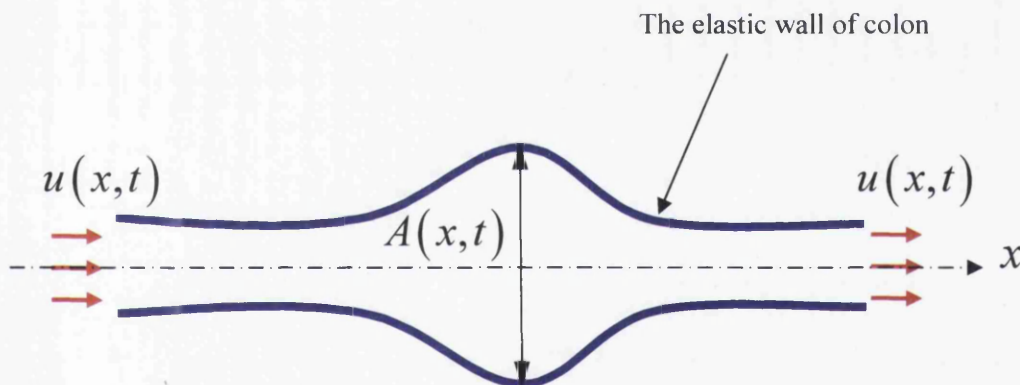

Figure 8.4 The gut model, where  $x$  denotes the location along the GI tract,  $t$  time,  $u(x,t)$  the velocity of gut media flow,  $A(x,t)$  the cross section area.

### 8.2.2 Mass conservation of the gut media flow

Without loss of generality, a segment of colon with a length  $l$  (between  $x=0$  and  $x=l$ ) is considered, as shown in Figure 8.4. At time  $t$ , the mass conservation for the gut media flow in this segment of colon can be expressed as

$$\frac{dM}{dt} + \rho(l,t)A(l,t)u(l,t) - \rho(0,t)A(0,t)u(0,t) = 0, \quad (8.1)$$

where  $M$  denote the total mass of gut media remaining in this segment of colon at time  $t$  and  $\rho(x,t)$  is the bulk density of the gut media. The above equation can be written in the integral form as

$$\frac{\partial}{\partial t} \int_0^l \rho(x,t)A(x,t) dx + \int_0^l \frac{\partial}{\partial x} [\rho(x,t)A(x,t)u(x,t)] dx = 0, \quad (8.2a)$$

$$\int_0^l \frac{\partial}{\partial t} [\rho(x,t)A(x,t)] dx + \int_0^l \frac{\partial}{\partial x} [\rho(x,t)A(x,t)u(x,t)] dx = 0, \quad (8.2b)$$

$$\int_0^l \left\{ \frac{\partial}{\partial t} [\rho(x,t)A(x,t)] + \frac{\partial}{\partial x} [\rho(x,t)A(x,t)u(x,t)] \right\} dx = 0. \quad (8.2c)$$

As the length  $l$  is arbitrary, Eqn. (8.2c) is equivalent to

$$\frac{\partial}{\partial t} (\rho A) + \frac{\partial}{\partial x} (\rho A u) = 0. \quad (8.3)$$

The above partial differential equation represents the mass conservation for the bulk flow in the gut. It is fundamentally different from previous chemostat and plug flow models, where no deformation of the gut is allowed.

### 8.2.3 Momentum conservation of the gut media flow

Considering the same bulk flow in the gut as in Section 8.2.2, the momentum conservation at time  $t$  can be expressed as

$$\frac{\partial}{\partial t} \int_0^l \rho A u dx + \rho A u^2 \Big|_{x=l} - \rho A u^2 \Big|_{x=0} = F, \quad (8.4)$$

where  $F$  represents the total external force exerted on the gut media flow. Eqn. (8.4) can be rewritten in the integral form as

$$\int_0^l \frac{\partial}{\partial t} (\rho A u) dx + \int_0^l \frac{\partial}{\partial x} (\rho A u^2) dx = F. \quad (8.5)$$

The total external force can be represented as follows:

$$F = pA \Big|_{x=0} - pA \Big|_{x=l} + \int_0^l \left( \int_{\Omega} p_x d\Omega \right) dx + \int_0^l f dx, \quad (8.6)$$

where the first two terms represent the pressure forces at each end of the colon segment, the third term represents the accumulated pressure along the colon segment, and the last term represents the total friction force exerted by the colon wall onto the gut media flow.

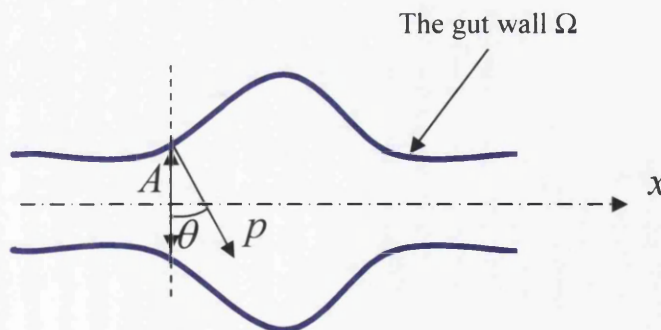

Figure 8.5 Illustration of the pressure from the gut wall to the gut media flow



As shown in Figure 8.5, the accumulated pressure along the gut segment can be calculated as

$$\int_{\Omega} p_x d\Omega = \int_{\Omega} p \sin \theta d\Omega = p \frac{\partial A}{\partial x}. \quad (8.7)$$

The dynamic friction between the gut wall and the gut media flow is assumed to be proportional to the flow velocity  $u$  and the dynamic viscosity  $\mu$  of gut media, such that

$$f = k\mu u, \quad (8.8)$$

where  $k$  is a constant depending on the velocity profile along the cross section of gut. Eqn. (8.8) is a common treatment in engineering applications for the friction force between the fluid and the wall.

Substituting Eqn. (8.7) and Eqn. (8.8) into Eqn. (8.6) yields

$$F = \int_0^l -\frac{\partial(pA)}{\partial x} dx + \int_0^l p \frac{\partial A}{\partial x} dx + \int_0^l k\mu u dx, \quad (8.9a)$$

$$F = \int_0^l \left( -A \frac{\partial p}{\partial x} + k\mu u \right) dx. \quad (8.9b)$$

Eqn. (8.9b) is the total external force exerted onto the gut media flow, which includes both pressure and friction contributions. Substituting Eqn. (8.9b) into Eqn. (8.5) yields

$$\int_0^l \frac{\partial}{\partial t} (\rho A u) dx + \int_0^l \frac{\partial}{\partial x} (\rho A u^2) dx = \int_0^l \left( -A \frac{\partial p}{\partial x} + k\mu u \right) dx. \quad (8.10)$$

As the length  $l$  is arbitrary, the above integral equation is equivalent to

$$\frac{\partial}{\partial t}(\rho Au) + \frac{\partial}{\partial x}(\rho Au^2) = -A \frac{\partial p}{\partial x} + k\mu u. \quad (8.11)$$

Eqn. (8.11) represents the momentum conservation of the bulk flow of gut media. The interaction between the gut wall and the gut media flow

#### 8.2.4 The interaction between the gut wall and the gut media flow

There are three unknowns in the mass conservation equation (8.3) and momentum conservation equation (8.11), namely the velocity  $u$ , the cross section area  $A$  and the pressure  $p$ . To solve the system, an extra equation must be supplied. The dynamic interaction between the gut wall and the gut media flow provides this necessary relation to close the equation system.

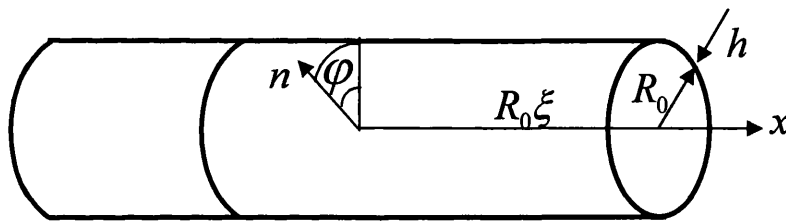

Figure 8.6 Timoshenko's shell model for the gut wall

As gut media move very slowly in the colon, the interaction between the gut wall and the gut media flow can be considered as quasi-static such that the gut wall is in the equilibrium state. Timoshenko's thin shell theory (Timoshenko et al. 1959) is employed here to analyze the gut wall under equilibrium. Consider the cylindrical gut wall shown in Figure 8.6, the governing equations of equilibrium are

$$\left( \frac{\partial^2}{\partial \xi^2} + \frac{1-\nu}{2} \frac{\partial^2}{\partial \varphi^2} \right) u_\xi + \frac{1+\nu}{2} \frac{\partial^2 u_\varphi}{\partial \xi \partial \varphi} + \nu \frac{\partial u_n}{\partial \xi} = -\frac{R_0^2 (1-\nu^2)}{Eh} q_\xi, \quad (8.12a)$$

$$\frac{1+\nu}{2} \frac{\partial^2 u_\xi}{\partial \xi \partial \varphi} + \left[ \frac{1-\nu}{2} \frac{\partial^2}{\partial \xi^2} + \frac{\partial^2}{\partial \varphi^2} \right] u_\varphi + \frac{\partial}{\partial \varphi} (1-a^2 \nabla^2) u_n = -\frac{R_0^2 (1-\nu^2)}{Eh} q_\varphi, \quad (8.12b)$$

$$v \frac{\partial u_\xi}{\partial \xi} + \frac{\partial}{\partial \varphi} \left[ 1 - a^2 \left( (2-v) \frac{\partial^2}{\partial \xi^2} + \frac{\partial^2}{\partial \varphi^2} \right) \right] u_\varphi + (1 + a^2 \nabla^2 \nabla^2) u_n = \frac{R_0^2 (1-v^2)}{Eh} q_n, \quad (8.12c)$$

where  $R_0$  is the rest radius of the cylindrical gut,  $h$  the thickness of the gut wall,

$E$  Young's modulus of the gut wall,  $\nu$  Poisson's ratio of the gut wall,  $\xi = \frac{x}{R_0}$ ,

$a^2 = \frac{h^2}{12R_0^2}$ ,  $\nabla^2 = \frac{\partial^2}{\partial \varphi^2} + \frac{\partial^2}{\partial \xi^2}$ ;  $u_\xi$ ,  $u_\varphi$  and  $u_n$  are the longitudinal, tangential and

normal displacements, respectively; and  $q_\xi$ ,  $q_\varphi$ , and  $q_n$  are the distributed loads along the longitudinal, tangential and normal directions, respectively.

As the gut deformation is predominantly in the normal direction, the deformation in the longitudinal and tangential directions are ignored here. Thus, all derivatives with respect to  $\xi$  and  $\varphi$  vanish in Eqns. (8.12a-c), and Eqn. (8.12c) becomes

$$u_n = \frac{R_0^2 (1-v^2)}{Eh} q_n. \quad (8.13)$$

In Eqn. (8.13), the displacement along the normal direction can be expressed as

$$u_n = R - R_0 = \frac{\sqrt{A} - \sqrt{A_0}}{\sqrt{\pi}}, \quad (8.14)$$

where  $R$  denotes the radius of the colon after deformation,  $R_0$  the radius of the colon at rest,  $A$  the cross section area of the colon after deformation,  $A_0$  the cross section area of the colon at rest.

In Eqn. (8.13), the distributed load along the normal direction can be expressed as

$$q_n = p - p_0, \quad (8.15)$$

where  $p$  denotes the pressure from the gut media flow to the wall and  $p_0$  the atmospheric pressure.

Substitution of Eqn. (8.14) and Eqn. (8.15) into Eqn. (8.13) yields

$$p = p_0 + \frac{\sqrt{\pi} E h (\sqrt{A} - \sqrt{A_0})}{A_0 (1 - \nu^2)}. \quad (8.16)$$

Through a simple algebraic relation, Eqn. (8.16) links the pressure  $p$  to the area  $A$  and closes the equations system. Hence, the mass conservation equation (8.3), the momentum conservation equation (8.11) and the wall-flow interaction equation (8.16) together form the general governing equations for the bulk flow of gut media, which determine the bulk velocity of the gut media flow  $u$ , the pressure of the gut media flow  $p$  and the cross section area of the gut  $A$ .

### 8.3 Stokes flow of gut media

For UK adults, the transit time of gut media in the colon is about 55 hours. It is also known that for adults, the average length of colon is about 1.5 m, and the average diameter is about 0.06 m. The density of gut media is similar to water, at  $10^3 \text{ kg/m}^3$ . The gut media are known to be a very sticky fluid, but it is hard to find in the literature the exact viscosity of gut media for humans. However, for reference, the dynamic viscosity of blood is  $3.5 \times 10^{-3} \text{ Pa}\cdot\text{s}$ , while the dynamic viscosity of honey is  $6 \text{ Pa}\cdot\text{s}$ . Using the blood viscosity, the Reynolds number of the gut media flow can be estimated as

$$Re = \frac{\rho u L}{\mu} = \frac{10^3 \times \frac{1.5}{55 \times 60 \times 60} \times 0.06}{3.5 \times 10^{-3}} = 0.13. \quad (8.17)$$

Using the honey viscosity, the Reynolds number of the gut media flow can be estimated as

$$Re = \frac{\rho u L}{\mu} = \frac{10^3 \times \frac{1.5}{55 \times 60 \times 60} \times 0.06}{6} = 7.6 \times 10^{-5}. \quad (8.18)$$

The actual Reynolds number for flow in the gut is expected to be closer to the honey estimation. In any case, it can be safely concluded that the Reynolds number of the gut media flow is significantly less than one, i.e.  $Re \ll 1$ . In fluid mechanics, fluid flows with very low Reynolds numbers are called Stokes flow, for which the inertia force terms in the momentum equation can be ignored, compared to the viscous force term (Happel et al. 1981). Hence, the momentum equation (8.11) simplifies to

$$-A \frac{\partial p}{\partial x} + k \mu u = 0. \quad (8.19)$$

Taking into account the low Reynolds number nature of the gut media flow, the associated governing equations can be summarized as follows

$$\frac{\partial}{\partial t}(\rho A) + \frac{\partial}{\partial x}(\rho A u) = 0, \quad (8.20)$$

$$\frac{\partial p}{\partial x} = \frac{k \mu u}{A}, \quad (8.21)$$

$$p = p_0 + \frac{\sqrt{\pi} E h (\sqrt{A} - \sqrt{A_0})}{A_0 (1 - \nu^2)}. \quad (8.22)$$

Eqn. (8.20) describes the mass conservation of the bulk flow in the gut, Eqn. (8.21) represents the momentum conservation, and Eqn. (8.22) determines the interaction between the gut wall and the gut media flow. These three simple equations govern the hydrodynamics of the bulk flow in the colon, and to the best of our knowledge they have never been reported in the literature. The fundamental difference between

our model and all previous models are twofold. First, the gut flow in the proposed model is driven by the pressure gradient, in contrast to a constant velocity (zero or non-zero) or being driven by the concentration gradient as in previous models. Secondly, the colon deformation is properly modelled in the new model, while all previous models have assumed the gut to be rigid and cannot even capture the most common physiological function or clinical conditions of the gut.

#### 8.4 Multiphase gut media

In Section 8.2 and Section 8.3, the movement of gut media has been treated as a bulk flow, moving at an average velocity. However, in reality, gut media is a mixture of various food particles, metabolic products, bacterial species, water and several different gases. To correctly model the growth and metabolic activities of various microbial species in the gut, it is essential to distinguish between the individual components in the flow model. Hence, the concept of volume fraction is introduced for this purpose, and the governing equations for the bulk flow (Eqns. (8.20-8.22)) need to be extended to cope with the multiphase flow.

The volume fraction  $\alpha_i$  of a component or phase  $i$  is defined as the volume of the component / phase divided by the total volume of all components / phases prior to mixing. Following the theory of multiphase flow (Yeoh et al. (2010); Brennen (2009); Crowe et al. (2012)), the bulk-flow governing equations (8.20-8.22) can be reconstructed for each individual component / phase in a multiphase flow system as

$$\frac{\partial}{\partial t}(\alpha_i \rho_i A) + \frac{\partial}{\partial x}(\alpha_i \rho_i A u_i) = 0, \quad (8.23)$$

$$\frac{\partial p_i}{\partial x} = \frac{k \mu_i u_i}{A}, \quad (8.24)$$

$$p_i = p_0 + \frac{\sqrt{\pi} E h (\sqrt{A} - \sqrt{A_0})}{A_0 (1 - v^2)}, \quad (8.25)$$

where  $i$  denotes the  $i$ -th component / phase,  $\alpha_i$  is the volume fraction of component  $i$ ,  $\rho_i$  the rest density of component  $i$ ,  $u_i$  the velocity of component  $i$ ,  $p_i$  the partial pressure of component  $i$ ,  $\mu_i$  the viscosity of component  $i$ ,  $k$  the resistant coefficient,  $A$  the cross section area of gut,  $p_0$  the atmospheric pressure,  $E$  Young's modulus of the gut wall,  $\nu$  Poisson's ratio of the gut wall,  $h$  the thickness of the gut wall, and  $A_0$  the cross section area of the gut when it is at rest.

It should be noted that the volume fractions  $\alpha_i$  are also unknown functions of the location  $x$  and time  $t$ . As the temperature change is not considered here, the rest density  $\rho_i$  is a constant for each component or phase. For the multiphase flow of gut media, Eqn. (8.23) represents the mass conservation with respect to the  $i$ -th component, Eqn. (8.24) represents the momentum conservation with respect to the  $i$ -th component, and Eqn. (8.25) represents the pressure-area relation determined by the interaction between the gut flow and the gut wall. The partial pressure of all components  $p_i$  has been assumed to share the same value, as indicated in Eqn. (8.25). The distribution of partial pressure among components / phases defines the constitutive relation of a multiphase flow, and the assumption that all components share the same pressure value is the most commonly adopted treatment in engineering applications. Such treatment is accurate for mixtures of immiscible components / phases, and is also a reasonable approximation for various other practical fluids. To close the equation system, the following identity of volume fractions is also needed:

$$\sum_{i=1}^N \alpha_i = 1, \quad (8.26)$$

where  $N$  denotes the total number of components / phases in the gut media flow. Eqns. (8.23-8.26) describe the movement of different food particles, bacterial species, metabolic products, water and gases in the colon. For a gut media flow with

$N$  components or phases, Eqns. (8.23-8.26) provide  $3N+1$  independent equations, and the independent unknowns include  $N$  volume fractions  $\alpha_i$ ,  $N$  velocities  $u_i$ ,  $N$  pressures  $p_i$ , and the cross section area of gut  $A$ . As different components / phases have different physical properties, they do not necessarily move at the same velocity, which sequentially causes a mixing effect and spatial heterogeneity in the colon.

## 8.5 Microbial fermentation in the gut

There are hundreds of microbial species living in the colon, and they breakdown dietary carbohydrate and protein not digested or absorbed in the small intestine into short chain fatty acids, which in turn provide energy for the host. This process is called fermentation, and it can be organized into a series of fermentation pathways, through which food chyme (undigested carbohydrate and protein from the ileum) is converted into metabolic products (e.g. short chain fatty acids) and biomass. For the multiphase flow of gut media, these fermentation pathways practically form various transformations between different components or phases, which can be captured as source or sink terms in the mass conservation equation (8.23). As the gut media flow is modelled as Stokes flow and the inertia forces are ignored in the momentum equation, the mass transformation caused by microbial fermentation does not affect the momentum equation (8.24). Also, the pressure-area relation in Eqn. (8.25) remains unchanged.

Another important feature of the colon that needs to be considered is the mucus layer, as shown in Figure 8.3 and Figure 8.7. In the human colon, microorganisms mix with food particles in the lumen and they also attach to the mucus layer. As gut media continuously flow through the lumen space, the mucus layer provides a more stable shelter site for bacteria to live in. The flow motion in the mucus layer is negligible, but the metabolic activities occurring on the mucus layer cannot be ignored. Indeed, it is generally believed that the mucus layer plays a key role for maintaining a stable population of gut microbiota.



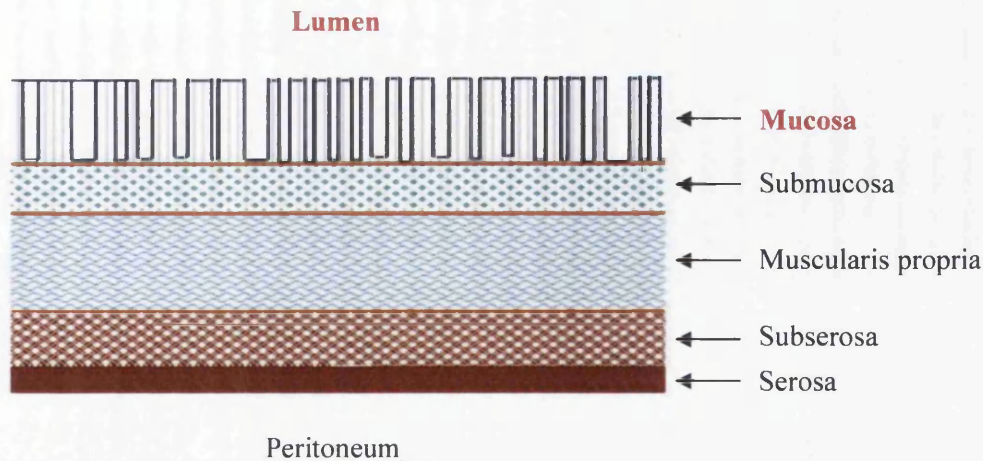

Figure 8.7 Anatomy of the colon. The lumen and the mucus layer are highlighted in red.

### 8.5.1 An outline of fermentation pathways

A fermentation pathway is a route through which a specific bacteria species metabolizes certain substrate (e.g. carbohydrate) to produce certain fermentation products (e.g. short chain fatty acids) and during this process, the population of the specific bacteria species grows.

The composition of substrates and fermentation products are relatively well known for the human gut environment. The main substrates in the human colon are dietary carbohydrate and dietary protein not digested in the upper gut. The main fermentation products are short chain fatty acids (acetate, propionate, butyrate etc.), hydrogen and carbon dioxide etc. However, much less is known about the population structure of gut microorganisms and their metabolic functions. For a long time, the biological and medical communities have been searching for a "core" microbiome for humans at the level of microbial species shared by everyone. But recent culture-independent surveys based on metagenomic sequencing indicate such a core does not exist at the level of species, and instead what appear to be shared are microbial functions (Turnbaugh et al. (2009a); Qin et al. (2010); McDonald et al. (2013)).

Table 8.1: Bacteria, their substrates and fermentation products in the human large intestine

Bacteria	Substrate	Fermentation products
Acetate-Succinate group (e.g. Bacteroides)	Carbohydrate and protein	A, P, S
Butyrate producer 1 (e.g. Clostridial cluster XIVa+b ( <i>Roseburia/Eubacterium rectal</i> group))	Carbohydrate and acetate	B, L-Lactate, F, H <sub>2</sub> , CO <sub>2</sub>
Butyrate producer 2 (e.g. Clostridial cluster IV ( <i>Faecalibacterium prausnitzii</i> ))	Carbohydrate and acetate	B, D-Lactate, F
Butyrate producer 3 (e.g. Clostridial cluster XIVa+b ( <i>Eubacterium hallii</i> ))	Carbohydrate, acetate and lactate	B, F, A, H <sub>2</sub> , CO <sub>2</sub>
Propionate producer (e.g. Clostridial cluster IX (Propionibacteria))	Carbohydrate, lactate, Succinate	P, A, CO <sub>2</sub>
Lactate producer 1 (e.g. Bifidobacteria)	Carbohydrate	L-Lactate, A
Lactate producer 2 (e.g. Lactobacilli)	Carbohydrate	L
Fiber degraders (e.g. Clostridial clusters IV(Ruminococci))	Carbohydrate	A
Non-butyrate starch degraders (e.g. Clostridial cluster IV ( <i>Ruminococcus bromii/Ruminococcus flavefaciens</i> ))	Carbohydrate	A, H <sub>2</sub> , CO <sub>2</sub> ,
Methanogenic bacteria (MB) (e.g. Methanobrevibacter/ Methanosphaera)	H <sub>2</sub> and CO <sub>2</sub>	CH <sub>4</sub>
Acetogens (e.g. Peptostreptococci)	H <sub>2</sub> , CO <sub>2</sub>	Acetate
Sulfate-reducing bacteria (SR) (e.g. Desulfovibrio)	H <sub>2</sub> and sulfate	H <sub>2</sub> S

A= acetate; P = propionate; B = butyrate; L= lactate; F = formate; S = succinate

Based on information collected from a number of references (Louis et al. (2007); Macfarlane et al. (1986a, 1986b, 2003); Nicholson et al. (2012); Mussatto et al. (2007); Dethlefsen et al. (2006); Cummings et al. (1997); Gibson et al. (1993, 1990); Bernalier et al. (1999)), the human gut microorganisms are divided into 12 functional groups (Table 8.1), and each functional group is associated with certain substrates and fermentation products. Table 8.1 is not expected to be complete or without defects, but it serves as a viable starting point to set up the mathematical model for microbial fermentation. It is highlighted that future updates to Table 8.1 will not affect the structure of the mathematical model to be presented here. Indeed, for newly identified fermentation pathways, the model only needs to be extended with new entries and its structure remains without change.

Let  $N$  denote the total number of components or phases in the gut media, which include different substrates, fermentation products and microbial species. Let  $\alpha_i$ ,  $i = 1, 2, \dots, N$  denote the volume fraction for each component or phase in the lumen, and let  $\alpha_i$ ,  $i = N+1, N+2, \dots, 2N$  denote the volume fraction for component or phase attached to the mucus layer. The indices  $i$  and  $N+i$  represent the same type of component, one for the lumen and the other for the mucus layer. Therefore, the rest densities of component  $i$  and component  $N+i$  are the same, i.e.

$$\rho_i = \rho_{N+i} \quad \text{for } i = 1, 2, \dots, N. \quad (8.27)$$

From the viewpoint of mass transformation, a fermentation pathway can be seen as the specific substrate converting into specific fermentation products and biomass. For the purpose of mathematical modelling, the fermentation pathways and their relations to different components or phases of gut media can be illustrated by the mass conversion matrix below

	1	2	...	$N$	$N+1$	$N+2$	...	$2N$
$f_1^L$	$f_{1,1}^L$	$f_{1,2}^L$	...	$f_{1,N}^L$	$f_{1,N+1}^L$	$f_{1,N+2}^L$	...	$f_{1,N+N}^L$
$f_2^L$	$f_{2,1}^L$	$f_{2,2}^L$	...	$f_{2,N}^L$	$f_{2,N+1}^L$	$f_{2,N+2}^L$	...	$f_{2,N+N}^L$
$\vdots$	$\vdots$	$\vdots$	$\vdots$	$\vdots$	$\vdots$	$\vdots$	$\vdots$	$\vdots$
$f_{N_F^L}^L$	$f_{N_F^L,1}^L$	$f_{N_F^L,2}^L$	...	$f_{N_F^L,N}^L$	$f_{N_F^L,N+1}^L$	$f_{N_F^L,N+2}^L$	...	$f_{N_F^L,N+N}^L$
$f_1^M$	$f_{1,1}^M$	$f_{1,2}^M$	...	$f_{1,N}^M$	$f_{1,N+1}^M$	$f_{1,N+2}^M$	...	$f_{1,N+N}^M$
$f_2^M$	$f_{2,1}^M$	$f_{2,2}^M$	...	$f_{2,N}^M$	$f_{2,N+1}^M$	$f_{2,N+2}^M$	...	$f_{2,N+N}^M$
$\vdots$	$\vdots$	$\vdots$	$\vdots$	$\vdots$	$\vdots$	$\vdots$	$\vdots$	$\vdots$
$f_{N_F^M}^M$	$f_{N_F^M,1}^M$	$f_{N_F^M,2}^M$	...	$f_{N_F^M,N}^M$	$f_{N_F^M,N+1}^M$	$f_{N_F^M,N+2}^M$	...	$f_{N_F^M,N+N}^M$

(8.28)

where the entries in the first row indicate the indices of different components found in the lumen ( $i=1,2,\dots,N$ ) and on the mucus layer ( $i=N+1,N+2,\dots,2N$ ), the entries in the first column indicate the fermentation pathways occurring in the lumen ( $f_1^L, f_2^L, \dots, f_{N_F^L}^L$ ) and on the mucus layer ( $f_1^M, f_2^M, \dots, f_{N_F^M}^M$ ),  $N_F^L$  is the total number of fermentation pathways occurring in the lumen,  $N_F^M$  is the total number of fermentation pathways occurring on the mucus layer, the matrix entry  $f_{j,i}^L$  represents the mass yield of the component  $i$  during the  $j$ -th fermentation pathway in the lumen, and the matrix entry  $f_{j,i}^M$  represents the mass yield of the component  $i$  during the  $j$ -th fermentation pathway on the mucus layer. The unit of the mass yields  $f_{j,i}^L$  and  $f_{j,i}^M$  is  $\text{kg}/(\text{m}\cdot\text{s})$ , representing the mass yield undertaken in a unit time and within a unit length of the colon.

To explain how the entries  $f_{j,i}^L$  and  $f_{j,i}^M$  in the mass conversion matrix (8.28) are determined, the  $j$ -th fermentation pathway in the lumen is considered here as an example. Let  $T$  denote the specific functional group of bacteria that participates in this fermentation pathway,  $S$  denote the corresponding substrate, and  $(i_1, i_2, \dots, i_{p_j})$  denote the associated fermentation products. Following the new microbial growth

model proposed in Chapter 7, the growth rate of the functional microbe  $T$  can be expressed as

$$f_{j,T}^L = \frac{D_{j,T}^L B_{j,T}^L (\rho_S \alpha_S) (\rho_T \alpha_T)}{C_{j,T}^L + \rho_S \alpha_S + \sum_{k=1}^{2N} \varepsilon_{j,Tk}^L (\rho_k \alpha_k)}, \quad (8.29)$$

where  $\rho_i$  denotes the rest density of the component  $i$ ,  $\alpha_i$  the volume fraction of the component  $i$ ,  $D_{j,T}^L = 1$  the mass yield coefficient of the microbe  $T$  during the  $j$ -th fermentation pathway in the lumen,  $B_{j,T}^L$  the maximum specific growth rate of the microbe  $T$  during the  $j$ -th fermentation pathway in the lumen,  $C_{j,T}^L$  the velocity-delay coefficient of the microbe  $T$  during the  $j$ -th fermentation pathway in the lumen,  $\varepsilon_{j,Tk}^L$  the interaction coefficient between the microbe  $T$  and the component  $k$  during the  $j$ -th fermentation pathway in the lumen.

Corresponding to the growth of microbe  $T$ , the mass change of the substrate  $S$  can be expressed as

$$f_{j,S}^L = \frac{D_{j,S}^L B_{j,T}^L (\rho_S \alpha_S) (\rho_T \alpha_T)}{C_{j,T}^L + \rho_S \alpha_S + \sum_{k=1}^{2N} \varepsilon_{j,Tk}^L (\rho_k \alpha_k)}, \quad (8.30)$$

where  $D_{j,S}^L$  is the mass yield coefficient for the substrate  $S$  during the  $j$ -th fermentation pathway in the lumen. Similarly, the mass changing rate of the fermentation products  $i_1, i_2, \dots, i_{p_j}$  can be expressed as

$$f_{j,i_k}^L = \frac{D_{j,i_k}^L B_{j,T}^L (\rho_S \alpha_S) (\rho_T \alpha_T)}{C_{j,T}^L + \rho_S \alpha_S + \sum_{k=1}^{2N} \varepsilon_{j,Tk}^L (\rho_k \alpha_k)} \quad k = 1, 2, \dots, P_j. \quad (8.31)$$

where  $D_{j,i_k}^L$  denotes the mass yield coefficient for the component  $i_k$  during the  $j$ -th fermentation pathway in the lumen.

As the mass conservation law must be satisfied during each fermentation pathway, the sum of the mass yield coefficients must be zero, i.e.

$$D_{j,S}^L + D_{j,T}^L + \sum_{k=1}^{P_j} D_{j,i_k}^L = 0. \quad (8.32)$$

For all other components that do not participate in this fermentation pathway, the mass yield coefficients are zero, i.e.

$$D_{j,i}^L = 0 \quad i \notin \{S, T, i_1, i_2, \dots, i_{P_j}\}, \quad (8.33a)$$

$$f_{j,i}^L = 0 \quad i \notin \{S, T, i_1, i_2, \dots, i_{P_j}\}. \quad (8.33b)$$

In reality, most fermentation pathways only involve a small number of components, including the specific substrate, fermentation products and biomass. As a result, most entries in the matrix (8.28) vanish, and the mass conversion matrix is highly sparse. The metabolic processes must satisfy the mass conservation law, therefore the following identities hold for the mass yields  $f_{i,j}^L$  and  $f_{i,j}^M$ :

$$\sum_{i=1}^{2N} f_{j,i}^L = 0 \quad \text{for } j = 1, 2, \dots, N_F^L, \quad (8.34a)$$

$$\sum_{i=1}^{2N} f_{j,i}^M = 0 \quad \text{for } j = 1, 2, \dots, N_F^M. \quad (8.34b)$$

### 8.5.2 Mass conservation in the lumen

Based on Eqn. (8.23) and taking into account the component transformation through fermentation pathways in Eqn. (8.28), the mass conservation equation for the gut media flow in the lumen can be constructed for each component  $i = 1, 2, \dots, N$  as

$$\frac{\partial}{\partial t}(\alpha_i \rho_i A) + \frac{\partial}{\partial x}(\alpha_i \rho_i A u_i) = F_i^L + G_i^L + H_i. \quad (8.35)$$

In Eqn. (8.35), the first source term  $F_i^L$  on the right-hand-side represents the mass contribution through various fermentation pathways to component  $i = 1, 2, \dots, N$  in the lumen, and it can be expressed as

$$F_i^L = \sum_{j=1}^{N_F^L} f_{j,i}^L(\alpha) + \sum_{j=1}^{N_F^M} f_{j,i}^M(\alpha), \quad (8.36)$$

where  $\alpha = (\alpha_1, \alpha_2, \dots, \alpha_{2N})^T$  is the volume fraction vector for all components in the lumen and on the mucus layer.

The second source term  $G_i^L$  in Eqn. (8.35) represents the absorption effect of component  $i$  in the lumen, and can be expressed as

$$G_i^L = -g_i \alpha_i \rho_i, \quad (8.37)$$

where  $g_i$ ,  $i = 1, 2, \dots, N$  represents the absorption rate of component  $i$  in the lumen. Note that the death of bacteria is ignored here. But if necessary, it can be similarly modelled as the absorption term.

The last source term  $H_i$  in Eqn. (8.35) represents the transport of component  $i$  and component  $N+i$  between the mucus layer and the lumen, and it can be expressed as

$$H_i = -h_i \alpha_i \rho_i \left( 1 - \sum_{j=1}^N \alpha_{N+j} \right) + h_{N+i} \alpha_{N+i} \rho_{N+i}, \quad (8.38)$$

where  $h_i \in (0,1)$  represents that transport rate for component  $i$  from the lumen to the mucus layer, and  $h_{N+i} \in (0,1)$  represents the transport rate for component  $N+i$  from the mucus layer to the lumen. This component-exchange model assumes that the transport of component  $i$  from the lumen to the mucus layer is proportional to its volume fraction in the lumen and also proportional to the free sites available on the mucus layer. The transport of component  $N+i$  from the mucus layer to the lumen is assumed to be proportional to its volume fraction on the mucus layer, while there is no space limit from the lumen side.

Besides the mass conservation equation (8.35), the volume fractions  $\alpha_i$ ,  $i = 1, 2, \dots, N$  in the lumen must also satisfy the identity

$$\sum_{i=1}^N \alpha_i = 1. \quad (8.39)$$

This identity does not hold for the mucus layer, because the volume fraction of free sites on the mucus layer is denoted by  $1 - \sum_{j=1}^N \alpha_{N+j}$ .

### 8.5.3 Mass conservation on the mucus layer

The governing equation for mass conservation on the mucus layer can be similarly constructed. The only difference is that on the mucus layer, the velocity of each



component is negligible and set to zero. Therefore, the mass conservation for each component  $i = N + 1, N + 2, \dots, 2N$  on the mucus layer can be expressed as

$$\frac{\partial}{\partial t} (\alpha_i \rho_i A^M) = F_i^M + G_i^M - H_i, \quad (8.40)$$

where  $A^M$  represents the constant cross section area of the mucus layer.

In Eqn. (8.40), the first term on the right-hand-side represents the mass contribution through various fermentation pathways to the component  $i = N + 1, N + 2, \dots, 2N$  on the mucus layer, and can be expressed

$$F_i^M = \sum_{j=1}^{N_F^L} f_{j,i}^L(\alpha) + \sum_{j=1}^{N_F^M} f_{j,i}^M(\alpha). \quad (8.41)$$

The above equation has the same format as Eqn. (8.36), but it should be noted that the component index  $i$  takes values from different ranges and deal with different components in the matrix (8.28). Eqn. (8.36) applies to the lumen with  $i = 1, 2, \dots, N$ , while Eqn. (8.41) applies to the mucus layer with  $i = N + 1, N + 2, \dots, 2N$ .

The second term in the right-hand-side of Eqn. (8.40) represents the absorption effect of the component  $i = N + 1, N + 2, \dots, 2N$  on the mucus layer, and can be expressed as

$$G_i^M = -g_i \alpha_i \rho_i. \quad (8.42)$$

where  $g_i$  is the absorption rate of component  $i$ . Eqn. (8.42) and Eqn. (8.37) share the same form, but they represent different groups of components. Again, the death of bacteria is ignored here.

The last source term  $H_i$  in Eqn. (8.40) is the same as in Eqn. (8.38), representing the component exchange between the lumen and the mucus layer.

## 8.6 Summary and discussion

A comprehensive mathematical model for the human gut and the gut microbial ecosystem has been established in this Chapter. The new model integrates the conservation laws for the gut media flow, the deformation of the gut wall, and the microbial fermentation into one system, for which the governing equations are summarized below:

$$\frac{\partial}{\partial t}(\alpha_i \rho_i A) + \frac{\partial}{\partial x}(\alpha_i \rho_i A u_i) = F_i^L + G_i^L + H_i \quad i = 1, 2, \dots, N, \quad (8.43)$$

$$\sum_{i=1}^N \alpha_i = 1, \quad (8.44)$$

$$\frac{\partial}{\partial t}(\alpha_i \rho_i A^M) = F_i^M + G_i^M - H_i \quad i = N+1, N+2, \dots, 2N, \quad (8.45)$$

$$\frac{\partial p_i}{\partial x} = \frac{k \mu_i u_i}{A} \quad i = 1, 2, \dots, N, \quad (8.46)$$

$$p_i = p_0 + \frac{\sqrt{\pi} E h (\sqrt{A} - \sqrt{A_0})}{A_0 (1 - \nu^2)} \quad i = 1, 2, \dots, N. \quad (8.47)$$

Eqn. (8.43) and Eqn. (8.44) represent the mass conservation in the lumen; Eqn. (8.45) represents the mass conservation on the mucus layer; Eqn. (8.46) represents the momentum conservation in the lumen; and Eqn. (8.47) represents the interaction between the gut medial flow and the gut wall. The microbial fermentation is modelled by the source terms  $F_i^L$  and  $F_i^M$  in Eqn. (8.43) and Eqn. (8.45). The absorption effect of the colon is modelled by the sink terms  $G_i^L$  and  $G_i^M$  in Eqn.

(8.43) and Eqn. (8.45). The  $H_i$  term in Eqn. (8.43) and Eqn. (8.45) represents the component exchange between the lumen and the mucus layer.

The derivation of these equations is based on reliable knowledge of the human gut and gut microorganisms, physical laws, rigorous mathematical formulations and appropriate approximations. To the best of our knowledge, the proposed mathematical model for the human gut and gut microbial ecosystem is the first model of its nature.

It will be interesting to develop appropriate numerical algorithms to solve these equations, and to investigate the human gut and the gut microbial ecosystem through computer simulations. However, this task is beyond the scope of the current research project. One of the main challenges for the future numerical study is to determine the model parameters. The new model contains only a small number of physical parameters, including viscosity and density of gut media, Young's modulus and Poisson's ratio of the gut wall, and the cross section area etc. These physical parameters are relatively easy to find in the literature or estimate based on experience. The real challenge arises from the fermentation pathways represented by the mass conversion matrix (8.28), whose entries are defined by the microbial growth model in Eqns. (8.29-8.31). Estimation of the parameters in the microbial growth model requires large sets of reliable data on microbial metabolic activities in the gut.

# Chapter 9 Conclusion and Future Work

## 9.1 Conclusion

This research investigated the microbial ecosystem in the human gut. A novel and unique research strategy has been adopted, which combines the strengths of *in vitro* experiments, *in vivo* trials and mathematical modelling. The main body of work can be summarized into three distinct and interrelated parts.

### 9.1.1 *In vitro* experiments

Following a unique design of an anaerobic workstation, a continuous fermentation platform has been built from scratch, which provides a flexible and reliable gut-like environment for various *in vitro* experiments related to gut microbiota. A series of batch fermentation experiments have been carried out to investigate the growth behaviour of a specific set of probiotic strains in different media and under different pH conditions. In addition, a series of continuous fermentation experiments have been performed using both single-stage chemostat setting and two-stage chemostat setting, to study the competition between gut microorganisms and these probiotic strains in a simulated gut environment. The results obtained from these *in vitro* experiments have improved the understanding of the metabolic activity of these probiotic strains in the human gut. These first-hand data also served as a reliable reference for validation of the new mathematical model proposed in this research.

---

### 9.1.2 *In vivo* studies

Using the next generation DNA sequencing technology (454-pyrosequencing), 50 faecal samples from 9 healthy infants were analyzed. These 9 infants were part of a large clinical trial, which involved both healthy and atopic infants with probiotic administration during the last week of pregnancy and the first six months after birth. The 454-pyrosequencing analysis revealed the complete gut microbiota profiles of these infants at different stages. The results show the specific probiotic strains used in the *in vivo* trials did have a positive effect on the development of infant gut microbiota. However, due to the lack of accurate diet information, the data generated from the *in vivo* study are unsuitable for use in mathematical modelling.

### 9.1.3 Mathematical modelling

The classic Monod model was extended to resolve the paradox of competitive exclusion. The new bacteria growth model has been extensively validated using the data obtained from the *in vitro* experiments carried out in this research. Good agreement between the simulation results and the *in vitro* data has been achieved in all cases. Using the new growth model, a versatile simulation framework has been developed, which is capable of simulating and predicting microbial competition in various *in vitro* fermentation experiments. Finally, a comprehensive mathematical model was proposed for the human gut and gut microbial ecosystem. This new theoretical model contains four integrated features recognizing, respectively, the deformation of the gut, the nature of low Reynolds number flow in the GI tract, the multiphase nature of gut media and microbial fermentation activities. To our best knowledge, this new gut model is the first mathematical model that correctly takes into account the anatomy of the gut, the flow of gut media and microbial metabolism.

## 9.2 Future work

This research represents the first step of Swansea's research group in the multidisciplinary field of gut microbiology and engineering modelling. An ambitious

---

target was set to join together the complementary strengths of *in vitro* experiment, *in vivo* study and mathematical modelling. Starting from scratch, a series of promising research outcomes have been achieved in all three research themes. Still, many aspects of this research can be seen as exploratory and feasibility studies, which have shed light on promising future research. Listed below is an incomplete list of further research that can be identified from this work.

- The continuous fermentation platform designed in this research can be viewed as a prototype gut simulator. It would be interesting to continue along this line and improve the current platform into a full artificial gut simulator. Indeed, external funding has been secured to further develop this platform for quick testing of probiotic products.
- Limited by funding, the 454-pyrosequencing analysis only studied healthy infants with administration of probiotic strains. It would be interesting to see how the specific probiotic strains have worked on atopic infants.
- The mathematical gut model proposed in this work has a number of advantages over previous theories and models. It would be very exciting to see how the new model performs in numerical simulation of gut microbiota and its interaction with the host.
- Validation against *in vitro* fermentation experiments has been extensively used in this research. DNA sequencing analysis based on *in vivo* studies generates large cohorts of data with complete profiles of gut microbiota. At least in principle, these data sets can also help the development of mathematical / computational models, although quantification of the diet input is required.
- Great variability of gut microbiota exists between individuals. This may indicate a promising future for host-specific simulation of gut microbial ecosystem.

### 9.3 Publication

Jiang, L., Plummer, S., Li, C. F., et al., 2012. Experimental-based stochastic modelling of the growth of lactobacilli and bifidobacteria in an in-vitro anaerobic intestinal ecosystem. *The 8th INRA-Rowett Symposium "Gut Microbiota: Friend or Foe"*, Clermont-Ferrand, France, 17-20th June, 2012.

Jiang, L., Plummer, S., Li, C. F., Owen D. R. J., 2013a. On human gut microbial ecosystem: *in vitro* experiment and mathematical modelling. Journal paper in preparation.

Jiang, L., Plummer, S., Li, C. F., Owen, D. R. J., 2013b. Mathematical modelling of human gut and gut microbial ecosystem. *The 3rd International Conference on Computational & Mathematical Biomedical Engineering*, Hong Kong, China, 16-18 December 2013.

---

# References

- Abrahamsson, T. R., Jakobsson, H. E., Andersson, A. F., et al., 2012. Low diversity of the gut microbiota in infants with atopic eczema. *J Allergy Clin Immunol* 129(2), 434-440.
- Abrahamsson, T. R., Jakobsson, T., Bottcher, M. F., et al., 2007. Probiotics in prevention of IgE-associated eczema: a doubleblind, randomized, placebo-controlled trial. *J Allergy Clin Immunol* 119(5), 1174-1180.
- Abrahms, S. A., Griffin, I. J., Hawthorne, K. M., et al., 2005. A combination of prebiotic short- and long-chain-type fructans enhances calcium absorption and bone mineralization in young adolescents. *Am J Clin Nutr* 82(2), 471-476.
- Adiotomre J. A., Eastwood M. A., Edwards C. A., et al., 1990. Dietary fiber *in vitro* methods that anticipate nutrition and metabolic activity in humans. *Am J Clin Nutr* 52(1), 128-134.
- Agheyisi, R., 2008. The probiotic market: Ingredients, supplements, foods, Report code: FOD035B, BCC Research, Wellesley, MA, USA (<http://www.bccresearch.com/report/FOD035B.html>).
- Alander, M., De Smet, I., Nollet, L., et al., 1999. The effect of probiotic strains on the microbiota of the Simulator of the Human Intestinal Microbial Ecosystem (SHIME). *Int J Food Microbiol* 46(1), 71-79.
- Alhaj, O. A., Kanekian, A. D., Peters, A. C., 2007. Investigation on whey proteins profile of commercially available milk-based probiotics health drinks using fast protein liquid chromatography. *Brit Food J* 109(6), 469-480.
- Allen, A., Carroll, N. J., 1985. Adherent and soluble mucus in the stomach and duodenum. *Dig Dis Sci* 30(11 Suppl), 55S-62S.
- Allen, S. J., Jordan, S., Storey, M., et al., 2010. Dietary supplementation with lactobacilli and bifidobacteria is well tolerated and not associated with adverse events during late pregnancy and early infancy. *J Nutr* 140(3), 483-488.
- Allen, S. J., Okoko, B., Martinez, E., 2004. Probiotics for treating infectious diarrhoea. *Cochrane Database Syst Rev* (2), CD003048.
- Allison, C., McFalane, C., Macfarlane, G. T., 1989. Studies on mixed populations of human intestinal bacteria grown in single-stage and multistage continuous culture systems. *Appl Environ Microbiol* 55(3), 672-678.
- Amaretti, A., Bernardi, T., Tamburini, E., et al., 2007. Kinetics and metabolism of *Bifidobacterium adolescentis* mb 239 growing on glucose, galactose, lactose, and galactooligosaccharides. *Appl Environ Microbiol* 73(11), 3637-3644.



- 
- Amor, K. B., Vaughan, E. E., 2006. Molecular ecology of the human intestinal microbiota. In *Gastrointestinal Microbiology* (ed. Ouwehand, A. C and Vaughan, E. E.), Taylor & Francis Group, New York.
- Anson, N. M., van den Berg, R., Havenaar, R., et al., 2009. Bioavailability of ferulic acid is determined by its bioaccessibility. *J of Cereal Science* 49(2), 296-300.
- Arboleya, S., Ang, L., Margolles, A., et al., 2012b. Deep 16S rRNA metagenomics and quantitative PCR analyses of the premature infant fecal microbiota. *Anaerobe* 18(3), 378-380.
- Arboleya, S., Binetti, A., Salazar, N., et al., 2012a. Establishment and development of intestinal microbiota in preterm neonates. *FEMS Microbiol Ecol* 79(3) 763-772.
- Arboleya, S., Salazar, N., Solis, G., et al., 2013. Assessment of intestinal microbiota modulation ability of *Bifidobacterium* strains in *in vitro* fecal batch cultures from preterm neonates. *Anaerobe* 19, 9-16.
- Arunachalam, K. D., 1999. Role of Bifidobacteria in nutrition, medicine and technology. *Nutr Res* 19(10), 1559-1597.
- Ataie-Jafari, A., Larijani, B., Majd, H. A., et al., 2009. Cholesterol-lowering effect of probiotic yogurt in comparison with ordinary yogurt in mildly to moderately hypercholesterolemic subjects. *Ann Nutr Metab* 54(1), 22-27.
- Atuma, C., Strugala, V., Allem, A., et al., 2001. The adherent gastrointestinal mucus gel layer: Thickness and physical state *in vivo*. *Am J Physiol Gastrointest Liver Physiol* 280(5), G922-G929.
- Backhed, F., Ding, H., Wang, T., et al., 2004. The gut microbiota as an environmental factor that regulates fat storage. *Proc Natl Acad Sci USA* 101(44), 15718-15723.
- Backhed, F., Ley, R. E., Sonnenburg, J. L., et al., 2005. Host-bacterial mutualism in the human intestine. *Science* 307(5717), 1915-1920.
- Baghurst, P. A., Baghurst, K. I., Record, S. J., 1996. Dietary fibre, non-starch polysaccharides and resistant starch: A review. *Food Aust* 48, S3-S35.
- Bahrami, B., Child, M. W., Macfarlane, S., et al., 2011. Adherence and cytokine induction in Caco-2 cells by bacterial populations from a three-stage continuous-culture model of the large intestine. *Appl Environ Microbiol* 77(9), 2934-2942.
- Bailey, M. T., Dowd, S. E., Parry, N. M., et al., 2010. Stressor exposure disrupts commensal microbial populations in the intestines and leads to increased colonization by *Citrobacter rodentium*. *Infect Immun* 78(4), 1509-1519.
- Ballal, S. A., Gallini, C. A., Segata, N., et al., 2011. Host and gut microbiota symbiotic factors: lessons from inflammatory bowel disease and successful symbionts. 2011. *Cell Microbiol* 13(4), 508-517.
- Ballyk, M. M., Smith, H., 2001. Microbial competition in reactors with wall attachment: a mathematical comparison of chemostat and plug flow models. *Microb. Ecol.* 41, 210-221.
- Ballyk, M., Dung, L., Jones, D. A., 1998. Effects of random motility on microbial growth and competition in a flow reactor. *SIAM J. Appl. Math.* 59(2), 573-596.
- Ballyk, M., Smith, H., 1999. A model of microbial growth in a plug flow reactor with wall attachment. *Mathematical Biosciences* 158(1999), 95-126.
-

- 
- Barrangou, R., Azcarate-Peril, M. A., Duong, T., et al., 2006. Global analysis of carbohydrate utilization by *Lactobacillus acidophilus* using cDNA microarrays. *Proc Natl Acad Sci USA* 103(10), 3861-3821.
- Barry, J. L., Hoebler, C., Macfarlane, G. T., 1995. Estimation of fermentability of dietary fibre in vitro: a European interlaboratory study. *Br J Nutr* 74(3), 303-322.
- Bartosch, S., Woodmansey, E. J., Paterson, J. C. M., et al., 2005. Microbiological effects of consuming a symbiotic containing *bifidobacterium bifidum*, *bifidobacterium lactis*, and oligofructose in elderly persons, determined by real-time polymerase chain reaction and counting of viable bacteria. *Clin Infect Dis* 40(1), 28-37.
- Beards, E., Tuohy, K., Gibson, G., 2010. Bacterial, SCFA and gas profiles of a range of food ingredients following *in vitro* fermentation by human colonic microiota. *Anaerobe* 16, 420-425.
- Becker, N., Kunath, J., Loh, G., et al., 2011. Human intestinal microbiota: characterization of a simplified and stable gnotobiotic rat model. *Gut Microbes* 2(1), 25-33.
- Belenguer, A., Duncan, S. H., Calder, A. G., et al., 2006. Two routes of metabolic cross-feeding between *Bifidobacterium adolescentis* and butyrate-producing anaerobes from the human gut. *Appl Environ Microbiol* 72(5), 3593-3599.
- Bennet, R., Eriksson, M., Nord, C. E., 2002. The fecal microflora of 1-3-month-old infants during treatment with eight oral antibiotics. *Infection* 30(3), 158-160.
- Berends, B. R., Urlings, H. A., Snijders, J. M., et al., 1996. Identification and quantification of risk factors in animal management and transport regarding *Salmonella* spp. in pigs. *Int J Food Microbiol* 30(1-2), 37-53.
- Bernalier, A., Dore, J., Durand, M., 1999. Biochemistry of fermentation in Colonic Microbiota, *Nutrition and Health*. (eds. G.R. Gibson; M.B. Roberfroid) Kluwer Academic Publishers, Netherlands.
- Bernalier, A., Rochet, V., Leclerc, M., et al., 1996a. Diversity of H<sub>2</sub>/CO<sub>2</sub>-utilizing acetogenic bacteria from feces of non methane-producing humans. *Curr Microbiol* 33(2), 94-99.
- Bernalier, A., Willems, A., Leclerc, M., et al., 1996b. *Ruminococcus hydrogenotrophicus* sp. nov., a new H<sub>2</sub>/CO<sub>2</sub>-utilizing acetogenic bacterium. *Arch Microbiol* 166(3), 176-183.
- Bervoets, L., Van Hoorenbeeck, K., Kortleven, I., et al., 2013. Differences in gut microbiota composition between obese and lean children: a cross-sectional study. *Gut Pathogens* 5, 10.
- Biagi, E., Candela, M., Fairweather-Tait, S., et al., 2012. Ageing of the human metaorganism: the microbial counterpart. *Age* 34(1), 247-267.
- Biasucci, G., Benenati, B., Morelli, L., et al., 2008. Cesarean delivery may affect the early biodiversity of intestinal bacteria. *J Nutr* 138(9), S1796-S1800.
- Biasucci, G., Rubini, M., Riboni, S., et al., 2010. Mode of delivery affects the bacterial community in the newborn gut. *Early Hum Dev* 86 Suppl 1, 13-15.
- Bisgaard, H., Li, N., Bonnelykke, K., et al., 2011. Reduced diversity of the intestinal microbiota during infancy is associated with increased of allergic disease at school age. *J Allergy Clin Immunol* 128(3), 646-652.
- Bjorksten, B., Sepp, E., Julge, K., et al., 2001. Allergy development and the intestinal microflora during the first year of life. *J Allergy Clin Immunol* 108(4), 516-520.
-

## References

---

- Blanquet-Diot, S., Meunier, J. P., Minekus, M., et al., 2003. Recombinant *Saccharomyces cerevisiae* expressing P450 in artificial digestive systems: a model for biotransformation in the human digestive environment. *Appl Environ Microbiol* 69(5), 2884-2892.
- Blanquet-Diot, S., Soufi, M., Rambeau, M., et al., 2009. Digestive stability of xanthophylls exceeds that of carotenes as studied in a dynamic in vitro gastrointestinal system. *J Nutr* 139(5), 876-883.
- Blaut, M., Collins, M. D., Welling, G. W., et al., 2002. Molecular biological methods for studying the gut microbiota: the EU human gut flora project. *Br J Nutr* 87 Suppl 2, S203-S211.
- Bottcher, M. F., Nordin, E. K., Sandin, A., et al., 2000. Microflora-associated characteristics in faeces from allergic and nonallergic infants. *Clin Exp Allergy* 30(11), 1590-1596.
- Bouhnik, Y., Raskine, L., Simoneau, G., et al., 2004. The capacity of nondigestible carbohydrates to stimulate fecal bifidobacteria in health humans: A double-blind, randomized, placebo-controlled, parallel-group, dose-response relation study. *Am J Clin Nutr* 80(6), 1658-1664.
- Boureau, H., Hartmann, L., Karjalainen, T., et al., 2000. Models to study colonisation and colonisation resistance. *Microb Ecol Health Dis* Suppl 2, 247-258.
- Bovee-Oudenhoven, I., Termont, D., Dekker, R., et al., 1996. Calcium in milk and fermentation by yoghurt bacteria increase the resistance of rats to *Salmonella* infection. *Gut* 38(1), 59-65.
- Braegger, C., Chmielewska, A., Decsi, T., et al., 2011. Supplementation of infant formula with probiotics and/or prebiotics: a systematic review and comment by ESPGHAN committee on nutrition. *J Pediatr Gastroenterol Nutr* 52(2), 238-250.
- Breitbart, M., Hewson, I., Felts, B., et al., 2003. Metagenomic analyses of an uncultured viral community from human feces. *J Bacteriol* 185(20), 6220-6223.
- Brenchley, J. M., Douek, D. C., 2012. Microbial translocation across the GI tract. *Annu Rev Immunol* 30, 149-173.
- Brennen, C. E., 2009. *Fundamentals of Multiphase Flow*. Cambridge University Press.
- Brook, I., 1999. Bacterial interference. *Crit Rev Microbiol* 25(3), 155-172.
- Brugere, J.-F., Mihajlovski, A., Missaoui, M., et al., 2009. Tools for stools: the challenge of assessing human intestinal microbiota using molecular diagnostics. *Expert Rev Mol Diagn* 9(4), 353-365.
- Bry L., Falk P.G., Midtvedt T., et al., 1996. A model of host-microbial interactions in an open mammalian ecosystem. *Science* 273(5280), 1380-1383.
- Burkitt D.P., Walker A.R.P., Painter N.S., 1972, Effect of dietary fibre on stools and transit times, and its role in the causation of disease. *Lancet* 2(7792), 1408-1412.
- Burr, D. H., Sugiyama, H., Harvis, G., 1982. Susceptibility to enteric botulinum colonization of antibiotic treated adult mice. *Infect Immun* 36(1), 103-106.
- Calloway, D. H., Murphy, E. L., 1968. The use of expired air to measure intestinal gas formation. *Ann New York Acad Sci* 150, 82-95.
- Cani, P. D., Bibiloni, R., Knauf, C., et al., 2008. Changes in gut microbiota control metabolic endotoxemia -induced inflammation in high-fat diet-induced obesity and diabetes in mice. *Diabetes* 57, 1470-1481.
-

- 
- Caplan, M. S., Hedlund, E., Adler, L., et al., 1994. Role of asphyxia and feeding in a neonatal rat model of necrotizing enterocolitis. *Pediatr Pathol* 14(6), 1017-1028.
- Cardona, M. E., 2002. Effect of probiotics on five biochemical microflora-associated characteristics, *in vitro* and *in vivo*. *Food & Nutrition Research* 46(2), 73-79.
- Cebra, J. J., 1999. Influences of microbiota on intestinal immune system development. *Am J Clin Nutr* 69(5), 1046S-1051S.
- Cerf-Bensussan, N., Gaboriau-Routhiau, V., 2010. The immune system and the gut microbiota: friends or foes? *Nat Rev Immunol* 10, 735-744.
- Chacko A., Cummings J. H., 1988. Nitrogen losses from the human small bowel: obligatory losses and the effect of physical form of food. *Gut* 29(6), 809-815.
- Charteris, W. P., Kelly, P. M., Morelli, L., et al., 1997. Selective detection, enumeration and identification of potentially probiotic *Lactobacillus* and *Bifidobacterium* species in mixed bacterial populations. *Int J Food Microbiol* 35(1), 1-27.
- Chassard, C., Bernalier-Donadille, A., 2006. H<sub>2</sub> and acetate transfers during xylan fermentation between a butyrate-producing xylanolytic species and hydrogenotrophic microorganisms from the human gut. *FEMS Microbiol Lett* 254 (1), 116-122.
- Cheng, J., Palva, A. M., de Vos, W. M., et al., 2013. Contribution of the intestinal microbiota to human health: from birth to 100 years of age. *Curr Top Microbiol* 358, 323-346.
- Cheshire, E., 1997. *Gastrointestinal System*. Mosby International Ltd., Missouri U.S.A..
- Chow, W. L., Lee, Y. K., 2006. Mucosal interactions and gastrointestinal microbiota. In *Gastrointestinal Microbiology* (ed. Ouwehand, A. C and Vaughan, E. E.), Taylor & Francis Group, New York.
- Cinquin, C., Blay, G. L., Fliss, I., et al., 2004. Immobilization of infant fecal microbiota and utilization in an *in vitro* colonic fermentation model. *Microb Ecol* 48(1), 128-138.
- Cinquin, C., Blay, G. L., Fliss, I., et al., 2006a. Comparative effects of exopolysaccharides from lactic acid bacteria and fructo-oligosaccharides on infant gut microbiota tested in an *in vitro* colonic model with immobilized cells. *FEMS Microbiol Ecol* 57(2), 226-238.
- Cinquin, C., Blay, G. L., Fliss, I., et al., 2006b. New three-stage *in vitro* model for infant colonic fermentation with immobilized fecal microbiota. *FEMS Microbiol Ecol* 57(2), 324-336.
- Clarke, J., Wu, H. C., Jayasinghe, L., et al., 2009. Continuous base identification for single-molecule nanopore DNA sequencing. *Nat Nanotechnol* 4, 265-270.
- Clemente, J. C., Ursell, L. K., Parfrey, L. W., et al., 2012. The impact of the gut microbiota on human health: an integrative view. *Cell* 148(6), 1258-1270.
- Clifford, M. N., 1999. Chlorogenic acids and other cinnamates-nature, occurrence and dietary burden. *J Sci Food Agric* 79(3), 362-372.
- Coleman, M. E., Dreesen, D. W., Wiegert, R. G., 1996. A simulation of microbial competition in the human colonic ecosystem. *Appl. Environ. Microbiol.* 62(10), 3632-3639.
- Collado, M. C., Delgado, S., Maldonado, A., et al., 2009. Assessment of the bacterial diversity of breast milk of healthy women by quantitative real-time PCR. *Lett Appl Microbiol* 48(5), 523-528.
-

- 
- Cook, S. I., Sellin, J. H., 1998. Review article: short chain fatty acids in health and disease. *Aliment Pharmacol Ther* 12(6), 499-507.
- Coolen, M. J., Post, E., Davis, C. C., et al., 2005. Characterization of microbial communities found in the human vagina by analysis of terminal restriction fragment length polymorphisms of 16S rRNA genes. *Appl Environ Microbiol* 71(12), 8729-8737.
- Corpet, D. E., 1989. Microbial ecology of the intestine. In vitro, in vivo and mathematical models. *Rev. Sci. Tech. Off. Int. Epiz* 8(2), 391-403.
- Costalos, C., Kapiki, A., Apostolou, M., et al., 2008. The effect of a prebiotic supplemented formula on growth and stool microbiology of term infants. *Early Hum Dev* 84(1), 45-49.
- Crittenden, R., Playne, M. J., 2006. Modifying the human intestinal microbiota with prebiotics. In *Gastrointestinal Microbiology* (eds. Ouwehand, A. C and Vaughan, E. E.), Taylor & Francis Group, New York.
- Crowe, C. T., Schwarzkopf, J. D., Sommerfeld, M., et al., 2012. *Multiphase Flows with Droplets and Particles*. Second Ed. CRC Press, London.
- Cummings J. H., Englyst H. N., 1987a. Fermentation in the large intestine and the available substrates. *Am J Clin Nutr* 45(5), 1243-1255.
- Cummings J. H., Gibson G. R., Macfarlane G. T., 1989. Quantitative estimates of fermentation in the hind gut of man. In *International Symposium on Comparative Aspects of the Physiology of Digestion in Ruminant and Hindgut Fermenters* (eds. Skadhauge, E., Norgaard, P.), Acta Vet. Scand Suppl 86: 76-82.
- Cummings J. H., Pomare E. W., Branch W. J., et al., 1987b. Short chain fatty acids in human large intestine, portal, hepatic and venous blood. *Gut* 28(10), 1221-1227.
- Cummings J.H., Banwell J.G., Segal I., et al., 1980. The amount and composition of large bowel contents in man. *Gastroenterology* 98, A408.
- Cummings J.H., Bingham S.A., Heaton K.W., et al., 1987c. Fecal weight, colon cancer risk and dietary intake of non-starch polysaccharides (dietary fiber). 103(6), 1783-1789.
- Cummings, J. H., 2009. Probiotics: better health from 'good' bacteria? *Nutr Bull* 34(2), 198-202.
- Cummings, J. H., Beatty, E. R., Kingman, S. M., et al., 1996. Digesting and physiological properties of resistant starch in the human large bowel. *Br J Nutr* 75(5), 733-747.
- Cummings, J. H., Macfarlane, G. T., 1991. The control and consequences of bacterial fermentation in the human colon. *J Appl Bacteriol* 70(6), 443-459.
- Cummings, J. H., Macfarlane, G. T., 1997. Role of intestinal bacteria in nutrient metabolism. *Clin Nutr* 16(1), 3-11.
- Cummings, J. H., Macfarlane, G. T., 2002. Gastrointestinal effects of prebiotics. *Br J Nutr* 87 Suppl 2, S145-S151.
- Cummings, J. H., Macfarlane, G. T., Englyst, H. N., 2000. Prebiotic digestion and fermentation. *Am J Clin Nutr* 73(2 Suppl), 415S-420S.
- David, S. E., Strozzyk, M. M., Naylor, T. A., 2010. Using TNO gastro-Intestinal Model (TIM1) to screen potential formulations for a poorly soluble development compound. *J Pharm Pharmacol* 62(10), S1236-S1237.
-

- 
- Davis, E., Rehberger, J., King, M., et al., 2010. Characterization of gastrointestinal microbial and immune populations post-weaning in conventionally-reared and segregated early weaned pigs. *Livestock Science* 133(1-3), 92-94.
- de Boer, R., Peters, R., Gierveld, S., et al., 2010. Improved detection of microbial DNA after bead-beating before DNA isolation. *J Microbiol Methods* 80(2), 209-211.
- De Boever, P., Deplancke, B., Verstraete, W., 2000. Fermentation by gut microbiota cultured in a Simulator of the Human Intestinal Microbial Ecosystem is improved by supplementing a soygerm powder. *J Nutr* 130(10), 2599-2606.
- De Boever, P., Wouters, R., Vermeirssen, V., et al., 2001. Development of a six-stage culture system for simulating the gastrointestinal microbiota of weaned infants. *Microb Ecol Health Dis* 13(2), 111-123.
- De Filippo, C., Cavalieri, D., Di Palao, M., et al., 2010. Impact of diet in shaping gut microbiota revealed by a comparative study in children from Europe and rural Africa. *Proc Natl Acad Sci USA* 107, 14691-14696.
- De Jong, P., Vissers, M. M. M., van der Meer, R. et al., 2007. In silico model as a tool for interpretation of intestinal infection studies. *Appl. Environ. Microbiol.* 73(2), 508-515.
- De Macias, M. E., Apella, M. C., Romero, N. C., et al., 1992. Inhibition of *Shigella sonnei* by *Lactobacillus casei* and *Lactobacillus acidophilus*. *J Appl Bacteriol* 73(5), 407-411.
- Desjardins, M., Roy, D., Toupin, C., et al., 1990. Uncoupling of growth and acids production in *Bifidobacterium* spp. *J Dairy Science* 73(6), 1478-1484.
- Dethlefsen, L., Eckburg, P. B., Bik, E. M., 2006. Assembly of the human intestinal microbiota. *Trends Ecol Evol* 21(9), 517-523.
- Dethlefsen, L., Huse, S., Sogin, M. L., et al., 2008. The pervasive effects of an antibiotic on the human gut microbiota, as revealed by deep 16S rRNA sequencing. *PLoS Biol* 6(11), e280.
- Dickinson, P. A., Abu Rmaileh, R., Ashworth, L., et al., 2012. An investigation into the utility of a multi-compartmental, dynamic, system of the upper gastrointestinal tract to support formulation development and establish bioequivalence of poorly soluble drugs. *AAPS J* 14(2), 196-205.
- Doleyres, Y., Fliss, I., Lacroix, C. 2002a. Quantitative determination of the spatial distribution of pure-and mixed-strain immobilized cells in gel beads by immunofluorescence. *Appl Microbiol Biotechnol* 59(2-3), 297-302.
- Doleyres, Y., Paquin, C., LeRoy, M., et al., 2002b. *Bifidobacterium longum* ATCC 15707 cell production during free- and immobilized-cell cultures in MRS-whey permeate medium. *Appl Microbiol Biotechnol* 60(1-2), 168-173.
- Dominguez-Bello, M. G., Costello, E. K., Contreras, M., et al., 2010. Delivery mode shapes the acquisition and structure of the initial microbiota across multiple body habitats in newborns. *Proc Natl Acad Sci USA* 107, 11971-11975.
- dos Santos, V. M., Muller, M., de Vos, W. M., 2010. Systems biology of the gut: the interplay of food, microbiota and host at the mucosal interface. *Curr Opin Biotech* 21(4), 539-550.
- Dotterud, C. K., Storro, O., Johnsen, R., et al., 2010. Probiotics in pregnant women to prevent allergic disease: a randomized, double-blind trial. *Br J Dermatol* 163(3), 616-623.
-

- 
- Duncan, S. H., Flint, H. J., 2013. Probiotics and prebiotics and health in ageing populations. *Maturitas* 75(1), 44-50.
- Duncan, S. H., Louis, P., Thomson, J. M., et al., 2009. The role of pH in determining the species composition of the human colonic microbiota. *Environ Microbiol* 11(8), 2112-2122.
- Duncan, S. H., Scott, K. P., Ramsay, A. G., et al., 2003. Effects of alternative dietary substrates on competition between human colonic bacteria in an anaerobic fermentor system. *Appl Environ Microbiol* 69(2), 1136-1142.
- Duncan, S.H., Holtrop, G., Lobley, G. E., et al., 2004. Contribution of acetate to butyrate formation by human faecal bacteria. *Br J Nutr* 91(6), 915-923.
- Dunne C., O'Mahony L., Murphy L., 2001. *In vitro* selection criteria for protiotic bacteria of human origin: correlation with *in vivo* findings. *Am J Clin Nutr* 73(2), 386S-392S.
- Durand M., Bernalier A., 1995. Reductive acetogenesis in animal and human gut. In: *Physiological and Clinical Aspects of Short-Chain Fatty Acids* (eds. Cummings J. H., Rombeau J. L., Sakata T.) Cambridge University Press, Cambridge.
- Dysseler, P., Hoffem, D., 1994. Estimation of resistant starch intake in Europe. In proceedings of the Concluding Plenary Meeting of EURESTA. *Eueopean Flair-Concerted Action* No. 11 (COST 911), 84-86.
- Eckburg, P. B., Bik, E. M., Bernstein, C. N., et al., 2005. Diversity of the human intestinal microbial flora. *Science* 308(5728), 1635-1638.
- Egert, M., de Graaf, A. A., Smidt, H., et al., 2006. Beyond diversity: functional microbiomics of the human colon. *Trends Microbiol* 14(2), 86-91.
- Engelbrektsen, A. L., Korzenik, J. R., Sanders, M. E., et al., 2006. Analysis of treatment effects on the microbial ecology of the human intestine. *FEMS Microbiol Ecol* 57(2), 239-250.
- Englyst H. N., Kingman S. M., Cummings J. H., 1992. Classification and measurement of nutritionally important starch fractions. *Eur J Clin Nutr* 46 Suppl 2, S33-S40.
- Englyst, H. N., Hay, S., Macfarlane, G. T., 1987. Polysaccharide breakdown by mixed populations of human faecal bacteria. *FEMS Microbiol Lett* 45(3), 163-171.
- Evaldson, G., Heimdahl, A., Kager, L., et al., 1982. The normal human anaerobic microflora. *Scan J Dis* 35, 9-15.
- Faith, J. J., McNulty, N. P., Rey, F. E., et al., 2011. Predicting a human gut microbiota's response to diet in gnotobiotic mice. *Science* 333(6038), 101-104.
- Falk, P. G., Hooper, L. V., Midtvedt, T., et al., 1998. Creating and maintaining the gastrointestinal ecosystem: what we know and need to know from gnotobiology. *Microbiol Mol Biol Rev* 62(4), 1157-1170.
- Fallani, M., Amarri, S., Uusijarvi, A., et al., 2011. Determinants of the human infant intestinal microbiota after the introduction of first complementary foods in infant samples from five European centres. *Microbiology* 157(5), 1385-1392.
- Fallani, M., Young, D., Scott, J., et al., 2010. Intestinal microbiota of 6-week-old infants across Europe: geographic influence beyond delivery mode, breast-feeding, and antibiotics. *J Pediatr Gastroenterol Nutr* 51(1), 77-84.
-

- 
- Falony, G., Calmeyn, T., Leroy, F., et al., 2009. Coculture fermentations of *Bifidobacterium* species and *Bacteroides thetaiotaomicron* reveal a mechanistic insight into the prebiotic effect of inulin-type fructans. *Appl Environ Microbiol* 75(8), 2312-2319.
- Falony, G., Vlachou, A., Verbrugghe, K., et al., 2006. Cross-feeding between *Bifidobacterium longum* BB536 and acetate-converting, butyrate-producing colon bacteria during growth on oligofructose. *Appl Environ Microbiol* 72(12), 7835-7841.
- Fernandez, L., Langa, S., Martin, V., et al., 2013. Human milk microbiota: origin and potential roles in health and disease. *Pharmacol Res* 69(1), 1-10.
- Finegold, S.M., Sutter, V.L., Mathisen, G.E., 1983. Normal indigenous intestinal flora. In *Human intestinal microflora in health and disease* (ed. ABAMS, G. D.), Academic Press, New York.
- Fiordaliso, M., Kok, N., Desager, J. P., et al., 1995. Dietary oligofructose lowers triglycerides, phospholipids and cholesterol in serum and very low density lipoproteins of rats. *Lipids* 30(2), 163-167.
- Fleming, S. E., Choi, S. Y., Fitch, M. D., 1991. Absorption of short-chain fatty acids from the rat cecum *in vivo*. *J Nutr* 121(11), 1787-1797.
- Flemings, D. E., Calloway, D. H., 1983. Determination of intestinal gas excretion. In *Dietary fibre* (eds. Birch, G. Parker, G), Applied Science Publishers, London.
- Flint, H. J., Duncan, S. H., Scott, K. P., et al., 2007. Interactions and competition within the microbial community of the human colon: links between diet and health. *Environ Microbiol* 9(5), 1101-1111.
- Flint, H. J., Scott, K. P., Louis, P., et al., 2012. The role of the gut microbiota in nutrition and health. *Nat Rev Gastroentero* 9(10), 577-589.
- Florin T. H. J., Neale G., Cummings J. H., 1990. The effect of dietary nitrate on nitrate and nitrite excretion in man. *Br J Nutr* 64, 387-397.
- Fooks, L. J., Fuller, R., Gibson, G. R., 1999. Prebiotics, probiotics and human gut microbiology. *Int Dairy J* 9(1), 53-61.
- Fooks, L. J., Gibson, G. R., 2002. Probiotics as modulators of the gut flora. *Br J Nutr* 88 Suppl 1, S39-S49.
- Forno, E., Onderdonk, A. B., McCracken, J., et al., 2008. Diversity of the gut microbiota and eczema in early life. *Clin Mol Allergy* 6, 11.
- Fouhy, F., Guinane, C. M., Hussey, S., et al., 2012a. High-throughput sequencing reveals the incomplete, short-term recovery of infant gut microbiota following parenteral antibiotic treatment with ampicillin and gentamicin. *Antimicrob Agents Chemother* 56(11), 5811-5820.
- Fouhy, F., Ross, P., Fitzgerald, G., et al., 2012b. Composition of the early intestinal microbiota: knowledge, knowledge gaps and the use of high-throughput sequencing to address these gaps. *Gut Microbes* 3(3), 203-220.
- Fraher, M. H., O'Toole, P. W., Quigley, E. M.M., 2012. Techniques used to characterize the gut microbiota: a guide for the clinician. *Nat Rev Gastroentero* 9(6), 312-322.
- Frank D. N., Amand, A.L.S., Feldman, R.A., et al., 2007. Molecular-phylogenetic characterization of microbial community imbalances in human inflammatory bowel diseases. *Proc Natl Acad Sci USA* 104(34), 13780-13785.
-



- 
- Frank, D. N., Pace, N. R., 2008. Gastrointestinal microbiology enters the metagenomics era. *Curr Opin Gastroenterol* 24(1), 4-10.
- Frankel, W. L., Zhang, W., Singh, A., et al., 1994. Mediation of the trophic effects of short-chain fatty acids on the rat jejunum and colon. *Gastroenterology* 106(2), 375-380.
- Fredrickson, A. G., Stephanopoulos G., 1981. Microbial competition. *Science* 213(28), 972-979.
- Freedman, H. I., So, J. W. H., Waltman, P., 1989. Coexistence in a model of competition in the chemostat incorporating discrete delays, *SIAM J. Appl. Math* 49(3), 859-870.
- Freter, R., 1983d. Mechanisms that control the microflora in the large intestine. *Human Intestinal Microflora in Health and Disease*. Hentges, D. (ed.), Academic Press, New York.
- Freter, R., Brickner, H., Botney, M. et al., 1983b. Mechanisms that control bacterial populations in continuous-flow culture models of mouse large intestinal flora. *Infect. Immun.* 39(2), 676-685.
- Freter, R., Brickner, H., Fekete, J. et al., 1983c. Survival and implantation of *Escherichia coli* in the intestinal tract. *Infect. Immun.* 39(2), 686-703.
- Freter, R., Stauffer, E., Cleven, D. et al., 1983a. Continuous-flow cultures as *in vitro* models of the ecology of large intestinal flora. *Infect. Immun.* 39(2), 666-675.
- Fritz, M., Siebert, G., Kasper, H., 1985. Dose dependence of breath hydrogen and methane in healthy volunteers after ingestion of a commercial disaccharide mixture, Palatinit. *Br J Nutr* 54, 389-400.
- Ganzle, M. G., Hertel, C., van der Vossen, J. M., et al., 1999. Effect of bacteriocin producing lactobacilli on the survival of *Escherichia coli* and *Listeria* in a dynamic model of the stomach and the small intestine. *Int J Food Microbiol* 48(1), 21-35.
- Gardiner, G. E., Heinemann, C., Baroja, M. L., 2002. Oral administration of the probiotic combination *Lactobacillus rhamnosus* GR-1 and *L.fermentum* RC-14 for human intestinal applications. *Int Dairy J* 12(2-3), 191-196.
- Garn, H., Renz, H., 2007. Epidemiological and immunological evidence for the hygiene hypothesis. *Immunobiology* 212(6), 441-452.
- Gibson G. R., Wang X., 1994a. Bifidogenic properties of different types of fructo-oligosaccharides. *Food Microbiol* 11(6), 491-498.
- Gibson G. R., Beatty E. R., Wang X., et al., 1995a. Selective stimulation of *Bifidobacteria* in the human colon by oligofructose and inulin. *Gastroenterology* 108(4), 975-982.
- Gibson G. R., Cummings J. H., Macfarlane G. T., 1988a. Use of a three-stage continuous culture system to study the effect of mucin on dissimilatory sulphate reduction and methanogenesis by mixed populations of human gut bacteria. *Appl Environ Microbiol* 54(11), 2750-2755.
- Gibson J. A., Sladen G. E., Dawson A. M., 1976. Protein absorption and ammonia production: the effects of dietary protein and removal of the colon. *Br J Nutr* 35(1), 61-65.
- Gibson, G. R., 1990a. A review – The physiology and ecology of sulphate-reducing bacteria. *J Appl Bacteriol* 69(6), 769-797.
- Gibson, G. R., 1999. Dietary modulation of the human gut microflora using prebiotics oligofructose and inulin. *J Nutr* 129(7 Suppl), S1438-S1441.
-

- 
- Gibson, G. R., Beaumont, A., 1996. Gut flora and health- past, present and future. In *An overview of human colonic bacteriology in health and disease* (eds. Lees, A.R., Rowland, I. R.), The Royal Society of Medicine Press Ltd., International congress and symposium series, UK.
- Gibson, G. R., Cummings, J. H., Macfarlane, G. T., 1988b. Competition for hydrogen between sulphate-reducing bacteria and methanogenic bacteria from the human large intestine. *J Appl Bacteriol* 65(3), 241-247.
- Gibson, G. R., Cummings, J. H., Macfarlane, G. T., et al., 1990b. Alternative pathways for hydrogen disposal during fermentation in the human colon. *Gut* 31(6), 679-683.
- Gibson, G. R., Fuller, R., 2000. Aspects of *in vitro* and *in vivo* research approaches directed toward identifying probiotics and prebiotics for human use. *J Nutr* 130 (2S Suppl), 391S-395S.
- Gibson, G. R., Macfarlane, G. T., Cummings, J. H., 1993. Sulphate reducing bacteria and hydrogen metabolism in the human large intestine. *Gut* 34, 437-439.
- Gibson, G. R., McCarteny, A. L., Rastall, R. A., 2005. Prebiotics and resistance to gastrointestinal infections. *Br J Nutr* 93 Suppl 1, S1-S34.
- Gibson, G. R., Probert, H. M., van Loo, J., et al., 2004. Dietary modulation of the human colonic microbiota: Updating the concept of prebiotics. *Nutr Res Rev* 17(2), 259-275.
- Gibson, G. R., Roberfroid, M. B., 1995b. Dietary modulation of the human colonic microbiota-introducing the concept of prebiotics. *J Nutr* 125(6), 1401-1412.
- Gibson, G. R., Wang, X., 1994b. Inhibitory effects of *bifidobacteria* on other colonic bacteria. *J Appl Bacteriol* 77(4), 412-420.
- Gibson, P. R., Moeller, I., Kagelari, O., et al., 1992. Contrasting effects of butyrate on the expression of phenotypic markers of differentiation in neoplastic colonic epithelial cells *in vitro*. *J Gastroenterol Hepatol* 7(2), 165-172.
- Gill, H. S., 2003. Probiotics to enhance anti-infective defences in the gastrointestinal tract. *Best Pract Res Clin Gastroenterol* 17(5), 755-773.
- Gill, S.R., Pop, M., Deboy, R.T., et al., 2006. Metagenomic analysis of the human distal gut microbiome. *Science* 312 (5778), 1355-1359.
- Gilliland, S. E., 1989. Acidophilus milk products: a review of potential benefits to consumers. *J Dairy Sci* 72(10), 2483-2494.
- Gloux, K., Leclerc, M., Ilioz, H., et al., 2007. Development of high-throughput phenotyping of metagenomic clones from the human gut microbiome for modulation of eukaryotic cell growth. *Appl Environ Microbiol* 73(11), 3734-3737.
- Goh, Y. J., Zhang, C., Benson, A. K., et al., 2006. Identification of a putative operon involved in fructooligosaccharide utilization by *Lactobacillus paracasei*. *Appl Environ Microbiol* 72(12), 7518-7530.
- Goldin, B. R., 2006. The metabolism of nutrients and drugs by the intestinal microbiota. In *Gastrointestinal Microbiology* (eds. Ouwehand, A. C and Vaughan, E. E.), Taylor & Francis Group, New York.
- Goodman, A. L., Kallstrom, G., Faith, J. J., et al., 2011. Extensive personal human gut microbiota culture collections characterized and manipulated in gnotobiotic mice. *Proc Natl Acad Sci USA* doi: 10.1073/pnas.1102938108.
-

- 
- Roesch, L. F., Lorca, G. L., Casella, G., et al., 2009. Culture-independent identification of gut bacteria correlated with the onset of diabetes in a rat model. *ISME J* 3(5), 536-548.
- Gophna, U., Sommerfeld, K., Gophna, S., et al., 2006. Differences between tissue-associated intestinal microfloras of patients with Crohn's disease and ulcerative colitis. *J Clin Microbiol* 44(11), 4136-4141.
- Gorbach, S. L., 2002. Probiotics in the third millenium. *Digest Liver Dis* 34 Suppl 2, S2-S7.
- Gorbach, S. L., Barza, M., Giulaiano, M., et al., 1988. Colonization resistance of the human intestinal microflora: testing the hypothesis in normal volunteers. *Eur J Clin Microbiol Infect Dis* 7(1), 98-102.
- Gottschalk, G., 1988. *Bacterial Metabolism* (Second Edition). Springer Verlag, New York.
- Gronlund, M. M., Gueimonde, M., Laitinene, K., et al., 2007. Maternal breast-milk and intestinal *bifidobacteria* guide the compositional development of the *Bifidobacterium* microbiota in infants at risk of allergic disease. *Clin Exp Allergy* 37(12), 1764-1772.
- Grootaert, C., Van den Abbeele, P., Marzorati, M., et al., 2009. Comparison of prebiotic effects of arabinoxylan oligosaccharides and inulin in a simulator of the human intestinal microbial ecosystem. *FEMS Microbiol Ecol* 69 (2), 231-242.
- Grzeskowiak, L., Gronlund, M. M., Beckmann, C., et al., 2012. The impact of perinatal probiotic intervention on gut microbiota: double-blind placebo-controlled trials in Finland and Germany. *Anaerobe* 18(1), 7-13.
- Guarner, F., Malagelada, J-R., 2003. Gut flora in health and disease. *Lancet* 361(9356), 512-519.
- Gueimonde, M., 2006. Effect of maternal consumption of *Lactobacillus* GG on transfer and establishment of fecal bifidobacterial microbiota in neonates. *J Pediatr Gastroenterol Nutr* 42(2), 166-170.
- Gumienna, M., Lasik, M., Czarnecki, Z., 2011. Bioconversion of grape and chokeberry wine polyphenols during simulated gastrointestinal in vitro digestion. *Int J Food Sci Nutr* 62(2), 226-233.
- Hansen, S. R., Hubbell, S. P., 1980. Single-nutrient microbial competition: qualitative agreement between experimental and theoretically forecast outcomes. *Science* 207(28), 1491-1493.
- Happel, J., Brenner, H., (1981) *Low Reynolds Number Hydrodynamics*, Springer.
- Harmsen, H. J., Wildeboer-Veloo, A. C, Raangs, G. C., et al., 2000. Analysis of intestinal flora development in breast-fed and formula-fed infants by using molecular identification and detection methods. *J Pediatr Gastroenterol Nutr* 30(1), 61-67.
- Hascoet, J. M., Hubert, C., Rochat, F., et al., 2011. Effect of formula composition on the development of infant gut microbiota. *J Pediatr Gastroenterol Nutr* 52(6), 756-762.
- Hazenber, M. P., Bakker, M., Verschoor-Burggraaf A., 1981. Effects of human intestinal microflora on germfree mice. *J Appl Bacteriol* 50(1), 95-106.
- Heidt, P. J., Koopman, J. P., Kennis, H. M., et al., 1990. The use of a rat-derived microflora for providing colonization resistance in SPF rats. *Lab Anim* 24(4), 375-379.
- Hell, M., Bernhofer, C., Stalzer, P., et al., 2013. Probiotics in *Clostridium difficile* infection: reviewing the need for a multistrain probiotic. *Benef Microbes* 4(1), 39-51.
-

- 
- Heller, S. N., Hackler, L. R., Rivers, J. M., et al., 1980. Dietary fibre: the effect of particle size of wheat bran on colonic function in young adult men. *Am J Clin Nutr* 33(8), 1734-1744.
- Hentges, D. J., 1993. The anaerobic microflora of the human body. *Clin Infect Dis* 16 Suppl 4, S175-S180.
- Hess, P., Altenhofer, A., Khan, A. S., et al., 2004. A *Salmonella* film homologue in *Citrobacter freundii* mediates invasion *in vitro* and crossing of the blood brain barrier in the rat pup model. *Infect Immun* 72, 5298-5307.
- Hickson, M., D'Souza, A. L., Muthu, N., et al., 2007. Use of probiotic *Lactobacillus* preparation to prevent diarrhoea associate with antibiotics: randomised double blind placebo controlled. *Brit Med J* 335, 80-83.
- Hill, M. J., 1997. Intestinal flora and endogenous vitamin synthesis. *Eur J Cancer Prev* 6(Suppl), S43-S45.
- Holzappel W.H., Haberer P., Snel J., et al., 1998. Overview of gut flora and probiotics. *Int J Food Microbiol* 41(2), 85-101.
- Hong P. Y., Lee, B. W., Aw, M., et al., 2010. Comparative analysis of fecal microbiota in infants with and without eczema. *PLoS ONE* 5(4), e9964.
- Hooper L.V., Midtvedt T., Gordon J.I., 2002. How host-microbial interactions shape the nutrient environment of the mammalian intestine. *Annu Rev Nutr* 22, 283-307.
- Hooper L.V., Xu J., Falk P.G., et al., 1999. A molecular sensor that allows a gut commensal to control its nutrient foundation in a competitive ecosystem. *Proc Natl Acad Sci USA*. 96(17), 9833-9838.
- Hopkins M. J., Cummings J. H., McFarlane G. T., 1998. Inter-species differences in maximum specific growth rates and cell yields of *bifidobacteria* cultured on oligosaccharides and other simple carbohydrate sources. *J Appl Microbiol* 85(2), 381-386.
- Hopkins, M. J., Macfarlane, G. T., 2003. Nondigestible oligosaccharides enhance bacterial colonization resistance against *Clostridium difficile in vitro*. *Appl Environ Microbiol* 69(4), 1920-1927.
- Hopkins, M. J., Macfarlane, G. T., Furrer, E. et al., 2005. Characterisation of intestinal bacteria in infant stools using real-time PRC and northern hybridisation analysis. *FEMS Microbiol Ecol* 54(1), 77-85.
- Hungate, R. E., Phillips, G. D., McGregor, A., et al., 1959. Microbial fermentation in certain mammals. *Science* 130(3383), 1192-1194.
- Ishak, H. D., Plowes, R., Sen, R., et al., 2011. Bacterial diversity in *Solenopsis invicta* and *Solenopsis geminata* ant colonies characterized by 16S amplicon 454 pyrosequencing. *Microb Ecol* 61(4), 821-831.
- Jackson, B. E., McInerney, M. J., 2002. Anaerobic microbial metabolism can proceed close to thermodynamic limits. *Nature* 415(6870), 454-456.
- Johansson, M. A., Sjogren, Y. M., Persson, J. O., et al., 2011. Early colonization with a group of Lactobacilli decreases the risk for allergy at five years of age despite allergic heredity. *PLoS One* 6(8), e23031.
-

- 
- Johansson, M. L., Molin, G., Jeppsson, B., et al., 1993. Administration of different *Lactobacillus* strains in fermented oatmeal soup: *in vivo* colonization of human intestinal mucosa and effect on the indigenous flora. *Appl Environ Microbiol* 59(1), 15-20.
- Joly, C., Gay-Queheillard, J., Leke, A., et al., 2013. Impact of chronic exposure to low doses of chlorpyrifos on the intestinal microbiota in the Simulator of the Human Intestinal Microbial Ecosystem (SHIME) and in the rat. *Environ Sci Pollut Res Int* 20(5), 2726-2734.
- Jones, D. A., Kojouharov, H. V., Le, D. et al., 2002. Bacterial wall attachment in a flow reactor. *SIAM J. Appl. Math.* 62(5), 1728-1771.
- Jones, D. A., Smith, H., 2000. Microbial competition for nutrient and wall sites in plug flow. *SIAM J. Appl. Math.* 60(5), 1576-1600.
- Jost, T., Lacroix, C., Braegger, C. P., et al., 2012. New insights in gut microbiota establishment in healthy breast fed neonates. *PLoS One* 7(8): e44595.
- Juarez Tomas, M. S., Bru de Labanda, E., de Ruiz Holgado, A. P., et al., 2002. Estimation of vaginal probiotic *lactobacilli* growth parameters with the application of the Gompertz model. *Can J Microbiol* 48(1), 82-92.
- Kabir, A. M., Aiba, Y., Takagi, A., et al., 1997. Prevention of *Helicobacter pylori* infection by *lactobacilli* in a gnotobiotic murine model. *Gut* 41(1), 49-55.
- Kalliomaki, M., Collado, M. C., Salminen, S., et al., 2008. Early differences in fecal microbiota composition in children may predict overweight. *Am J Clin Nutr* 87(3), 534-538.
- Kalliomaki, M., Kirjavainen, P., Eerola, E., et al., 2001. Distinct patterns of neonatal gut microflora in infants in whom atopy was and was not developing. *J Allergy Clin Immunol* 107(1), 129-134.
- Kanauchi, O., Oshima, T., Andoh, A., et al., 2008. Germinated barley foodstuff ameliorates inflammation in mice with colitis through modulation of mucosal immune system. *Scand J Gastroenterol* 43(11), 1346-1352.
- Kaplan, H., Hutkins, R. W., 2000. Fermentation of fructooligosaccharides by lactic acid bacteria and bifidobacteria. *Appl Environ Microbiol* 66(6), 2682-2684.
- Kassinen, A., Krogius-Kurikka, L., Makivuokko, H., et al., 2007. The fecal microbiota of irritable bowel syndrome patients differs significantly from that of healthy subjects. *Gastroenterology* 133(1), 24-33.
- Kerckhoffs, A. P., Samsom, M., van der Rest, M. E., et al., 2009. Lower *Bifidobacteria* counts in both duodenal mucosa-associated and fecal microbiota in irritable bowel syndrome patients. *World J Gastroenterol* 15(23), 2887-2892.
- Kim, J. Y., Kwon, J. H., Ahn, S. H., et al., 2010. Effect of probiotic mix (*Bifidobacterium bifidum*, *Bifidobacterium lactis*, *Lactobacillus acidophilus*) in the primary prevention of eczema: a double-blind, randomized, placebo controlled trial. *Pediatr Allergy Immunol* 21(2 Pt 2), e386-93.
- Kirjavainen, P. V., Gibson, G. R., 1999. Healthy gut microbiota and allergy: factors influencing development of the microbiota. *Ann Med* 31(4), 288-292.
- Kirjavainen, P. V., Salminen, S. J., Isolauri, E., 2003. Probiotic bacteria in the management of atopic disease: underscoring the importance of viability. *J Pediatr Gastr Nutr* 36(2), 223-227.
-

- 
- Kitajima, H., Sumida, Y., Tanaka, R., et al., 1997. Early administration of *Bifidobacterium breve* to preterm infants: randomised controlled trial. *Arch Dis Child Fetal Neonatal Ed* 76(2), 101-107.
- Kleerebezem, R., Stams, A. J., Mar 2000. Kinetics of syntrophic cultures: a theoretical treatise on butyrate fermentation. *Biotechnol Bioeng* 67(5), 529-543.
- Knudsen, A., van Zanten, G. C., Jensen, S. L., et al., 2013. Comparative fermentation of insoluble carbohydrates in an *in vitro* human feces model spiked with *Lactobacillus acidophilus* NCFM. *Starch* 65(3-4), 346-353.
- Kok, N., Roberfroid, M., Rober, A., 1996. Involvement of lipogenesis in the lower VLDL secretion induced by oligofructose in rats. *Br J Nutr* 76(6), 881-890.
- Kondo, S., Xiao, J. Z., Satoh, T., et al., 2010. Antiobesity effects of *bifidobacterium breve* strain B-3 supplementation in a mouse model with high-fat diet-induced obesity. *Biosci Biotech Bioch* 74(8), 1656-1661.
- Kontula, P., Jaskari, J., Nollet, L., et al., 1998. The colonization of a Simulator of Human Intestinal Microbial Ecosystem by a probiotic strain fed on a fermented oat bran product: effects on the gastrointestinal microbiota. *Appl Microbiol Biotechnol* 50(2), 246-252.
- Kopp, M.V., Hennemuth, I., Heinzmann, A., et al., 2008. Randomized, double-blind, placebo-controlled trial of probiotics for primary prevention: no clinical effects of *Lactobacillus* GG supplementation. *Pediatrics* 121(4), e850-6.
- Kukkonen, K., Savilahti, E., Haahtela, T., et al., 2007. Probiotics and prebiotic galacto-oligosaccharides in the prevention of allergic diseases: a randomized, double-blind, placebo-controlled trial. *J Allergy Clin Immunol* 119(1):192-198.
- Kung, C. M., Baltzis, B. C., 1992. The growth of pure and simple microbial competitors in a moving distributed medium, *Math. Biosci.* 111, 295-313.
- Kurokawa, K., Itoh, T., Kuwahara, T., et al., Aug 2007. Comparative metagenomics revealed commonly enriched gene sets in human gut microbiomes. *DNA Res* 14(4), 169-181.
- Lacroix, C., Yildirim, C., 2007. Fermentation technologies for the production of probiotics with high viability and function and protection. *Curr Opin Biotechnol* 18(2), 176-183.
- Lahtinen, S. J., Boyle, R. J., Kivivuori, S., et al., 2009. Prenatal probiotic administration can influence *Bifidobacterium* microbiota development in infants at high risk of allergy. *J Allergy Clin Immunol* 123(2), 499-501.
- Laird, B. D., James, K. J., Van de Wiele, T., et al., 2013. An investigation of the effect of gastrointestinal microbial activity on oral arsenic bioavailability. *J Environ Sci Heal A* 48(6), 612-619.
- Laird, B. D., Van de Wiele, T.R., Corriveau, M.C., et al., 2007. Gastrointestinal microbes increase arsenic bioaccessibility of ingested mine tailings using the simulator of the human intestinal microbial ecosystem. *Environ Sci Technol* 41(15), 5542-5547.
- Lajoie S. F., Banks S., Miller T. L., et al., 1988. Acetate production from hydrogen and (<sup>13</sup>C) carbon dioxide by the microflora of human feces. *Appl Environ Microbiol* 54(11), 2723-2727.
- Lambert, J., Kalra, A., Dodge, C. T., et al., 2013. Novel PCR-based methods enhance characterization of vaginal microbiota in a bacterial vaginosis patient before and after treatment. *Appl Environ Microbiol* 79(17), 4181-4185.
-

## References

---

- Lan, A., Bruneau, A., Philippe, C., et al., 2007. Survival and metabolic activity of selected strains of *Propionibacterium freudenreichii* in the gastrointestinal tract of human microbiota-associated rats. *Br J Nutr* 97(4), 714-724.
- Langlands, S. J., Hopkins, M. J., Coleman, N., et al., 2004. Prebiotic carbohydrates modify the mucosa associated microflora of the human large bowel. *Gut* 53(11), 1610-1616.
- Laux, D.C., Cohen, P.S., Conway, T., 2005. Role of the mucus layer in bacterial colonization of the intestine. In *Colonization of Mucosal Surfaces*. ASM Press, Washington DC.
- Lawson, D. J., Holtrop, G., Flint H. et al., 2011. Bayesian analysis of non-linear differential equation models with application to a gut microbial ecosystem. *Biometrical J.* 53(4), 543-556.
- Le Blay, G., Chassard, C., Baltzer, S., et al., 2010. Set up of a new *in vitro* model to study dietary fructans fermentation in formula-fed babies. *Br J Nutr* 103(3), 403-411.
- Le Blay, G., Rytka, J., Zihler, A., et al., 2009. New *in vitro* colonic fermentation model for *Salmonella* infection in the child gut. *FEMS Microbiol Ecol* 67(2), 198-207.
- Lee, Y. K., Puong, K. Y., 2002. Competition for adhesion between probiotics and human gastrointestinal pathogens in the presence of carbohydrate. *Brit J Nutr* 8 Suppl 1, S101-S108.
- Lepage, P., Colombet, J., Marteau, P., et al., 2008. Dysbiosis in inflammatory bowel disease: a role for bacteriophages? *Gut* 57 (3), 424-425.
- Lesmes, U., Beards, E. J., Gibson, G. R., et al., 2008. Effects of resistant starch type III polymorphs on human colon microbiota and short chain fatty acids in human gut models. *J Agric Food Chem* 56(13), 5415-5421.
- Levitt, M. D., 1971. Volume and composition of human intestinal gas determined by means of an intestinal washout technic. *New Engl J med* 284(25), 1394-1398.
- Ley, R. E., 2010. Obesity and the human microbiome. *Curr Opin Gastroenterol* 26(1), 5-11.
- Ley, R. E., Peterson, D. A., Gordon, J. I., 2006. Ecological and evolutionary forces shaping microbial diversity in the human intestine. *Cell* 124(4), 837-848.
- Lichtenberger, L.M., 1995. The hydrophobic barrier properties of gastrointestinal mucus. *Annu Rev Physiol* 57, 565-583.
- Lievin, V., Peiffer, I., Hudault, S., et al., 2000. *Bifidobacterium* strains from resident infant human gastrointestinal microflora exert antimicrobial activity. *Gut* 47(5), 646-652.
- Liu, Z., Lozupone, C., Hamady, M., et al., 2007. Short pyrosequencing reads suffice for accurate microbial community analysis. *Nucl Acids Res* 35(18), e120.
- Livesey, G., Elia, M., 1995. Short chain fatty acids as an energy source in the colon: metabolism and clinical implications. In *Physiological and Clinical Aspects of Short-Chain Fatty Acids* (eds. Cummings, J. H., Rombeau, J. L., Sakata, T), Cambridge University Press, Cambridge.
- Louis, P., Duncans, S. H., McCrae, S. I., et al., 2004. Restricted distribution of the butyrate kinase pathway among butyrate-producing bacteria from the human colon. *J Bacteriol* 186(7), 2099-2106.
- Louis, P., Scott, K. P., Duncan, S. H., et al., 2007. Understanding the effects of diet on bacterial metabolism in the large intestine. *J Appl Microbiol* 102(5), 1197-1208.
-

- 
- Lozupone, C. A., Stombaugh, J. I., Gordon, J. I., et al., 2012. Diversity, stability and resilience of the human gut microbiota. *Nature* 489, 220-230.
- Luoto, R., Isolauri, E., Lehtonen, L., 2010. Safety of *Lactobacillus* GG probiotic in infants with very low birth weight: twelve years of experience. *Clin Infect Dis* 50(9), 1327-1328.
- MacDonald, T. T., Gordon, J. N., 2005a. Bacterial regulation of intestinal immune responses. *Inflamm Bowel Dis* 6(2), 116-122.
- Macdonald, T. T., Monteleone, G., 2005. Immunity, inflammation, and allergy in the gut. *Science* 307(5717), 1920-1925.
- Macfarlane G. T., Gibson G. R., Beatty E. R., et al., 1992a. Estimation of short-chain fatty acid production from protein by human intestinal bacteria based on branched chain fatty acid measurements. *FEMS Microbiol Lett* 101(2), 81-88.
- Macfarlane G. T., Gibson G. R., Cummings J. H., 1992b. Comparison of fermentation reactions in different regions of the human colon. *J Appl bacteriol* 72(1), 57-64.
- Macfarlane, G. T., Cummings, J. H., Allison, C., 1986a. Protein degradation by human intestinal bacteria. *J Gen Microbiol* 132(6), 1647-1656.
- Macfarlane, G. T., Englyst, H. N., 1986b. Starch utilization by the human large intestinal microflora. *J Appl Bacteriol* 60(3), 195-201.
- Macfarlane, G. T., Macfarlane, S., 2007. Models for intestinal fermentation: association between food components, delivery systems, bioavailability and functional interactions in the gut. *Curr Opin Biotechnol* 18(2), 156-162.
- Macfarlane, G. T., Macfarlane, S., Gibosn, G. R., 1998. Validation of a three-stage compound continuous culture system for investigating the effect of retention time on the ecology and metabolism of bacteria in the human colon. *Microb Ecol* 35(2), 180-187.
- Macfarlane, G. T., Steed, H., Macfarlane, S., 2008. Bacterial metabolism and health-related effects of galacto-oligosaccharides and other prebiotics. *J Appl Microbiol* 104(2), 305-344.
- Macfarlane, G., et al., 1995. Metabolic significance of the gut microflora. In *Gastrointestinal and Oesophageal Pathology* (ed. Whitehead R.), 2d ed., Churchill livingstone, Edinburgh.
- Macfarlane, G.T., Cummings, J.H., 1991. The colonic flora, fermentation, and large bowel digestion function. In *The Large Intestine: Physiology, Pathophysiology and Disease* (eds. Phillips, S. F., Pemberton, J. H., Shorter, R. G.), Raven Press Ltd, London.
- Macfarlane, G.T., Gibson, G., 1997. Carbohydrate fermentation, energy transduction and gas metabolism in the human large intestine. In *Gastrointestinal Microbiology. Vol. 1* (eds. Mackie, R. I., White, B. A.), Chapman and Hall, London.
- Macfarlane, S., Dillon, J. F., 2007. Microbial biofilms in the human gastrointestinal tract. *J Appl Microbiol* 102(5), 1187-1196.
- Macfarlane, S., Macfarlane, G. T., 2003. Regulation of short-chain fatty acid production. *Proc Nutr Soc* 62(1), 67-72.
- Macfarlane, S., Macfarlane, G. T., Cummings, J. H., 2006a. Review article: Prebiotics in the gastrointestinal tract. *Aliment Pharmacol Ther* 24(5), 701-714.
- Macfarlane, S., Macfarlane, G.T., 2006b. Composition and metabolic activities of bacterial biofilms colonizing food residues in the human gut. *Appl Environ Microbiol* 72(9), 6204-6211.
-



- 
- Macfarlane, S., Woodmansey, E. J., Macfarlane, G. T., 2005. Colonization of mucin by human intestinal bacteria and establishment of biofilm communities in a two-stage continuous culture system. *Appl Environ Microbiol* 71(11), 7438-7492.
- Machado, A., Almeida, C., Carvalho, A., et al., 2013. Fluorescence in situ hybridization method using a peptide nucleic acid probe for identification of *Lactobacillus* spp. in milk samples. *Int J Food Microbiol* 162(1), 64-70.
- Mack, D. R., Ahrne, S., Hyde, L., et al., 2003. Extracellular MUC3 mucin secretion follow adherence of lactobacillus strains to intestinal epithelial cells *in vitro*. *Gut* 52, 827-833.
- Mack, D. R., Michail, S., Wei, S., et al., 1999. Probiotic inhibit enteropathogenic *E.coli* adherence *in vitro* by inducing mucin gene expression. *Am J Physiol* 276(4 Pt 1), G941-G950.
- Mackie, R. I., Sghir, A., Gaskins, H. R., 1999. Developmental microbial ecology of the neonatal gastrointestinal tract. *Am J Clin Nutr* 69(5), 1035S-1035S.
- Madden J. A., Plummer S., Tang, J., et al., 2005. Effect of probiotics on preventing disruption of the intestinal microflora following antibiotic therapy: A double-blind, placebo-controlled pilot study. *Int Immunophar* 5(6), 1091-1097.
- Mahowald, M. A., Rey, F. E., Seedorf, H., et al., 2009. Characterizing a model human gut microbiota composed of members of its two dominant bacterial phyla. *Proc Natl Acad Sci USA* 106(14), 5859-5864.
- Mai, V., Young, C. M., Ukhanova, M., et al. 2011. Fecal microbiota in premature infants prior to necrotizing enterocolitis. *PLoS One* 6(6), e20647.
- Makelainen, H., Makivuokko, H., Salminen, S., et al., 2007. The effects of polydextrose and xylitol on microbial community and activity in a 4-stage colon simulator. *J Food Sci* 72(5), M153-M159.
- Makivuokko, H., Forssten, S., Saarinen, M., et al., 2010. Synbiotic effects of lactitol and *Lactobacillus acidophilus* NCFM (TM) in a semi-continuous colon fermentation model. *Benef Microbes* 1(2), 131-137.
- Makivuokko, H., Nurmi, J., Nurminen, P., et al., 2005. *In vitro* effects on polydextrose by colonic bacteria and Caco-2 cell cyclooxygenase gene expression. *Nutr Cancer* 52(1), 93-103.
- Makivuokko, H., Saarinen, M., Ouwehand, A., et al., 2006. Effects of lactose on colon microbial community structure and function in a four-stage semi-continuous culture system. *Biosci Biotechnol. Biochem* 70(9), 2056-2063.
- Malin, M., Suomalainen, H., Saxelin, M., et al., 1996. Promotion of IgA immune response in patients with Crohn's disease by oral bacteriotherapy with *Lactobacillus* GG. *Ann Nutr Metab* 40(3), 137-145.
- Mallett, A. K., Rowland, I. R., 1998. Factors affecting the gut microbiota. In *Role of the Gut Flora in Toxicity and Cancer* (ed. Rowland, I), Academic Press, London.
- Manuela, C., Silvia, T., Elena, B., et al., 2013. A novel combined approach based on HTF-Microbi.Array and qPCR for a reliable characterization of the Bifidobacterium-dominated gut microbiota of breast-fed infants. *FEMS Microbiol Lett* 343(2), 121-126.
- Manzoni, P., Lista, G., Gallo, E., et al., 2011. Routine *Lactobacillus rhamnosus* GG administration in VLBW infants: a retrospective, 6-year cohort study. *Early Hum Dev* 87 Suppl 1, S35-S38.
-

- 
- Maqueda, M., Sanchez-Hidalgo, M., Fernandez, M., et al., 2008. Genetic features of circular bacteriocins produced by gram-positive bacteria. *FEMS Microbiol Rev* 32(1), 2-22.
- Mardis ER. 2008. Next-generation DNA sequencing methods. *Annu Rev Genomics Hum Genet* 9, 387-402.
- Marques, T. M., Wall, R., Ross, R. P., et al., 2010. Programming infant gut microbiota: influence of dietary and environmental factors. *Curr Opin Biotechnol* 21(2), 149-156.
- Marsh, P., 1995. The role of continuous culture in modelling the human microflora. *J Chem Tech Biotechnol* 64(1), 1-9.
- Marteau, P., Minekus, M., Havenaar, R., et al., 1997. Survival of lactic acid bacteria in a dynamic model of the stomach and small Intestine: validation and the effects of bile. *J Dairy Sci* 80(6), 1031-1037.
- Marteau, P., Rambaud, J. C., 1993. Potential of using lactic acid bacteria for therapy and immunomodulation in man. *FEMS Microbiol Rev* 12(1-3), 207-220.
- Martino, D. J., Currie, H., Taylor, A., et al., 2008. Relationship between early intestinal colonization, mucosal immunoglobulin A production and systemic immune development. *Clin Exp Allergy* 38(1), 69-78.
- Martoni, C., Bhatena, J., Urbanska, A. M., et al., 2008. Microencapsulated bile salt hydrolase producing *Lactobacillus reuteri* for oral targeted delivery in the gastrointestinal tract. *Appl Microbiol Biotechnol* 81(2), 225-233.
- Martoni, C., Bhatena, J., Jones, M. L., et al., 2007. Investigation of microencapsulated BSH active *lactobacillus* in the simulated human GI tract. *J Biomed Biotechnol* 2007, 1-9.
- Marzorati, M., Pinheiro, I., Van den Abbeele, P., Van et al., 2012. An *in vitro* technology platform to assess host-microbiota interactions in the gastrointestinal tract. *Agro Food Ind Hi Tec* 23(6), S8-S11.
- Marzorati, M., Possemiers, S., Van den Abbeele, P., et al., 2010. Technology and method to study microbial growth and adhesion to host-related surface and the host-microbiota interactions. WO Patent 2010/118857 A2, filed April 14, 2010.
- Marzorati, M., Van den Abbeele, P., Possemiers, D., et al., 2011. Studying the host-microbiota interaction in the human gastrointestinal tract: Basic concepts and *in vitro* approaches. *Annal Microbiol* 61(4), 709-715.
- Matamoros, S., Gras-Leguen, C., Le Vacon, F., et al., 2013. Development of intestinal microbiota in infants and its impact on health. *Trends Microbiol* 21(4), 167-173.
- Mathers, J. C., Annison, E. F., 1993. Stoichiometry of polysaccharide fermentation in the large intestine. In *Chemistry and Nutrition of Dietary Fibre and Beyond: Australian Perspectives*, (Occasional Publicaiton No. 1), Australian Nutrition Society, Australia.
- Matsuo, K., Ota, H., Akamatsu, T., et al., 1997. Histochemistry of the surface mucous gel layer of the human colon. *Gut* 40(6), 782-789.
- Mattila-Sandholm, T., Salminen, S., 1998. Up-to-date on probiotics in Europe. *Gastroenterol Intern* 1, 8-12.
- McCartney, A. L., Gibson, G. R., 2006. The normal microbiota of the human gastrointestinal tract: history of analysis, succession, and dietary influences. In *Gastrointestinal Microbiology* (ed. Ouwehand, A. C and Vaughan, E. E.), Taylor & Francis Goup, New York.
-

- 
- McDonald, D., Vazquez-Baeza, Y., Walters, W. A., et al., 2013. From molecules to dynamic biological communities. *Bio Philos* 28, 241-259.
- Mckay, L. F., Eastwood, M. A., Brydon, W. G., 1985. Methane excretion in man: a study of breath, flatus and faeces. *Gut* 26(1), 69-74.
- McKellar, R. C., Modler, H. W., 1989. Metabolism of fructooligosaccharides by *Bifidobacterium* spp. *Appl Microbiol Biotechnol* 31(5-6), 537-541.
- McNaught, C. E., MacFie, J. 2001. Probiotics in clinical practice: a critical review of the evidence. *Nutr Res* 21(1-2), 343-353.
- metagenomic sequencing. *Nature* 464(7285), 59-65.
- Mihajlovski, A., Alric, M., Brugere, J.-F., 2008. A putative new order of methanogenic archaea inhabiting the human gut, as revealed by molecular analyses of the mcra gene. *Res Microbiol* 159(7-8), 516-521.
- Miller T. L., Weaver G. A., Wolin M. J., 1984. Methanogens and anaerobes in a colon segment isolated from the normal fecal stream. *Appl Environ Microbiol* 48(2), 449-450.
- Miller T. L., Wolin M. J., 1982. Enumeration of *Methanobrevibacter smithii* in human feces. *Arch Microbiol* 133(1), 14-18.
- Miller T. L., Wolin M. J., 1983. Oxidation of hydrogen and reduction of methanol to methane is the sole energy source for a methanogen isolated from human feces. *J Bacteriol* 153(2), 1051-1055.
- Miller T. L., Wolin M. J., 1986. Methanogens in human and animal intestinal tracts. *Syst Appl Microbiol* 7(2-3), 223-229.
- Miller, T. L., Wolin, M. J., 1979. Fermentation by saccharolytic intestinal bacteria. *Am J Clin Nutr* 32(1), 164-172.
- Miller, T. L., Wolin, M. J., 1985. *Methanosphaera stadtmaniae* gen. nov., sp. nov.: a species that forms methane by reducing methanol with hydrogen. *Arch Microbiol* 141(2), 116-122.
- Miller, T. L., Wolin, M. J., 1996. Pathways of acetate, propionate, and butyrate formation by the human fecal microbial flora. *Appl Environ Microbiol* 62(5), 1589-1592.
- Minekus, M., Marteau, P., Havenaar, R., et al., 1995. A multi compartmental dynamic computer-controlled model simulating the stomach and small intestine. *Altern Lab Anim* 23(2), 197-209.
- Minekus, M., Smeets-Peeters, M., Bernalier, A., et al., 1999. A computer-controlled system to simulate conditions of the large intestine with peristaltic mixing, water absorption and absorption of fermentation products. *Appl Microbiol Biotechnol* 53(1), 108-114.
- Mitsuoka T., 1996. Intestinal flora and human health. *Asia Pacific J Clin Nutr* 15(1), 2-9.
- Mlobeli, N. T., Gutierrez, N. A., Maddox, I. S., 1998. Physiology and kinetics of *Bifidobacterium bifidum* during growth on different sugars. *Appl Microbiol Biotechnol* 50(1), 125-128.
- Moberg, L. J., Suugiyama, H., 1978. Microbial ecological basis of infant botulism as studied with germfree mice. *Infect Immun* 25(2), 653-657.
- Molly, K., DeSmet, I., Nollet, L., et al., 1996. Effect of Lactobacilli on the ecology of the gastro-intestinal microbiota cultured in the SHIME reactor. *Microb Ecol Health Dis* 9(2), 79-89.
-

- 
- Molly, K., Woestyne, M. V., Verstraete, W., 1993. Development of 5-step multichamber reactor as a simulation of the human intestinal microbial ecosystem. *Appl Microbiol Biotechnol* 39 (2), 254-258.
- Morrison, D. J., Mackay, W. G., Edwards, C. A., et al., 2006. Butyrate production from oligofructose fermentation by human faecal flora: what is the contribution of extracellular acetate and lactate? *Br J Nutr* 96(3), 570-577.
- Mountzouris, K. C., McCartney, A. L., Gibson, G. R., 2002. Intestinal microflora of human and infants and current trends for its nutritional modulation. *Br J Nutr* 87(5), 405-420.
- Mshvildadze, M., Neu, J., Shuster, J., et al., 2010. Intestinal microbial ecology in premature infants assessed with non-culture-based techniques. *J Pediatr* 156(1), 20-25.
- Munoz-Tamayo, R., Laroche, B., Walter E. et al., 2011. Kinetic modelling of lactate utilization and butyrate production by key human colonic bacterial species. *FEMS Microbiol. Ecol.* 76, 615-624.
- Munoz-Tamayo, R., Laroche, B., Walter, E. et al., 2010. Mathematical modelling of carbohydrate degradation by human colonic microbiota. *J. Theor. Biol.* 266, 189-201.
- Mussatto, S. I., Mancilha, I. M., 2007. Non-digestible oligosaccharides: A review. *Carbohydr Polym* 68(3), 587-597.
- Mysore, J. V., Duhamel, G. E., 1994. Morphometric analysis of enteric lesions in C3H/HeN mice inoculated with *Serpulina hyodysentericae* serotypes 2 and 4 with or without oral streptomycin pretreatment. *Can J Vet Res* 58(4), 281-286.
- Naidu, A. S., Bidlack, W. R., Clemens, R. A., 1999. Probiotic spectra of lactic acid bacteria (LAB). *Crit Rev Food Sci Nutr* 39(1), 13-126.
- Nakayama, J. 2010. Pyrosequence-based 16S rRNA profiling of gastro-intestinal microbiota. *Biosci Microflora* 29(2), 83-96.
- Nakayama, J., Kobayashi, T., Tanaka, S., et al., 2011. Aberrant structures of fecal bacterial community in allergic infants profiled by 16S rRNA gene pyrosequencing. *FEMS Immunol Med Microbiol* 63(3), 397-406.
- Neish, A. S., Gewirtz, A. T., Zeng, H., et al., 2000. Prokaryotic regulation of epithelial responses by inhibition of IkappaBalpha ubiquitination. *Science* 289(5484), 1560-1563.
- Newton, D. F., Macfarlane, S., Macfarlane, G. T., 2013. Effects of antibiotics on bacterial species composition and metabolic activities in chemostats containing defined populations of human gut microorganisms. *Antimicrob Agents Ch* 57(5), 2016-2025.
- Nicholson, J. K., Holmes, E., Kinross, J., et al., 2012. Host-gut microbiota metabolic interactions. *Science* 336(6086), 1262-1267.
- Nielsen, E. M., Schlundt, J., 1992. Use of norfoxacin to study colonization ability of *Escherichia coli* in vivo and in vitro models of the porcine gut. *Antimicrob Agents Chemother* 36(2), 401-407.
- Niers, L., Martin, R., Rijkers, G., et al., 2009. The effects of selected probiotic strains on the development of eczema (the Panda study). *Allergy* 64(9), 1349-1358.
- Noack, J., Timm, D., Hospattankar, A., et al., 2013. Fermentation profiles of wheat dextrin, inulin and partially hydrolyzed guar gum using an in vitro digestion pretreatment and in vitro batch fermentation system model. *Nutrients* 5(5), 1500-1510.
-

- 
- Nylund, L., Satokari, R., Nikkila, J., et al., 2013. Microarray analysis reveals marked intestinal microbiota aberrancy in infants having eczema compared to healthy children in at-risk for atopic disease. *BMC Microbiol* 13, 12.
- O'Toole, P. W., Claesson, M. J., 2010. Gut microbiota: Changes throughout the lifespan from infancy to elderly. *Int Dairy J* 20(4), 281-291.
- Ohtsuka, K., Benno, Y., Endo, A., et al., 1989. Effects of 4'-galactosyl-lactose intake on human fecal microflora, *Bifidus* 2, 143-149.
- Oien, T., Storro, O., Johnsen, R., 2008. Assessing atopic disease in children two to six years old: reliability of a revised questionnaire. *Prim Care Respir J* 17(3), 164-168.
- Olano-Martin, E., Mountzouris, K. C., Giboson, G. R., et al., 2000. *In vitro* fermentability of dextran, ologodextran and maltodextrin by human gut bacteria. *Br J Nutr* 83(3), 247-255.
- Orrhage, K., Lidbeck, A., Rafter, J., 1995. Influence of probiotics, lactobacilli and bifidobacteria on gastrointestinal disorders in adults. In *Role of Gut bacteria in Human Toxicology and Pharmacology* (ed. Hill, M. J.), Taylor & Francis, London.
- O'Sullivan, D. J., 2000. Methods for analysis of the intestinal microflora. *Curr Issues Intest Microbiol* 1(2), 39-50.
- Oulfi, L. E., Barry, J. L., Flourie, B., 2000. Relationships between transit time in man and *in vitro* fermentation of dietary fiber by fecal bacteria. *Eur J Clin Nutr* 54(8), 603-609.
- Ouwehand, A. C., Kirjavainen, P., V., Shortt, C., et al., 1999. Probiotics: mechanisms and established effects. *Int Dairy J* 9(1), 43-52.
- Ouwehand, A. C., Niemi, P., Salminen, S. J., 1999. The normal faecal microflora does not affect the adhesion of probiotic bacteria *in vitro*. *FEMS Microbiol Lett* 177(1), 35-38.
- Ouwehand, A. C., Salminen, S. J., Tolkkio, S., et al., 2002. Resected human colonic tissue: new model for characterizing adhesion of lactic acid bacteria. *Clin Diagn Lab Immunol* 9(1), 184-186.
- Palmer, C., Bik, E. M., DiGiulio, D. B., et al., 2007. Development of the human infant intestinal microbiota. *PLoS Biol* 5(7): e177.
- Partty, A., Kalliomaki, M., Endo, A., et al., 2012. Compositional development of *Bifidobacterium* and *Lactobacillus* microbiota is linked with crying and fussing in early infancy. *PLoS One* 7(3), e32495.
- Payne, A. N., Chassard, C., Banz, Y., et al., 2012b. The composition and metabolic activity of child gut microbiota demonstrate differential adaptation to varied nutrient loads in an *in vitro* model of colonic fermentation. *FEMS Microbiol Ecol* 80(3), 608-623.
- Payne, A. N., Zihler, A., Chassard, C., et al., 2012a. Advances and perspectives in *in vitro* human gut fermentation modelling. *Trends Biotechnol* 30(1), 17-25.
- Pazzaglia, G., Winoto, I., Jennings, G., 1994. Oral challenge with *Aeromonas* in protein-malnourished mice. *J Diarrhoeal Dis Res* 12(2), 108-112.
- Pearson, J.P., Brownlee, I.A., 2005. Structure and function of mucosal surfaces. In *Colonization of Mucosal Surfaces* (ed. Nataro, J. P.), ASM Press, Washington DC.
- Penders, J., Thijs, C., van den Brandt, P. A., et al., 2007. Gut microbiota composition and development of atopic manifestations in infancy: the KOALA Birth Cohort Study. *Gut* 56(5), 661-667.
-

- 
- Penders, J., Thijs, C., Vink, C., et al., 2006. Factors influencing the composition of the intestinal microbiota in early infancy. *Pediatrics* 118(2), 511-521.
- Pereira, D. I. A., Gibson, G. R., 2002. Cholesterol assimilation by lactic acid bacteria and bifidobacteria isolated from the human gut. *Appl Environ Microbiol* 68(9), 4689-4693.
- Perrin, S., Warchol, M., Grill, J. P., et al., 2001. Fermentations of fructo-oligosaccharides and their components by *Bifidobacterium infantis* ATCC 15697 on batch culture in semi-synthetic medium. *J Appl Microbiol* 90(6), 859-865.
- Petrof, E. O., Gloor, G. B., Vanner, S. J., et al., 2013. Stool substitute transplant therapy for the eradication of *Clostridium difficile* infection: "RePOOPulating" the gut. *Microbiome* 1, 3.
- Phillips, M. L., 2009. Gut reaction: environmental effects on the human microbiota. *Environ Health Perspect* 117(5), A198-A205.
- Pierre, F., Perrin, P., Champ, M., et al., 1997. Short-chain fructo-oligosaccharides reduce the occurrence of colon tumors and develop gut-associated lymphoid tissue in Min mice. *Cancer Res* 57(2), 225-228.
- Plummer, S. F., Garaiova, I., Sarvotham, T., et al., 2005. Effects of probiotics on the composition of the intestinal microbiota following antibiotic therapy. *Int J Antimicrob Agents* 26(1), 69-74.
- Plummer, S., Weaver, M. A., Harris, J. C., et al., 2004. *Clostridium difficile* pilot study: effects of probiotic supplementation on the incidence of *C. difficile* diarrhoea. *Int Microbiol* 7(1), 59-62.
- Pompei, A., Cordisco, L., Raimondi, S., et al., 2008. *In vitro* comparison of the prebiotic effects of two inulin-type fructans. *Anaerobe* 14(5), 280-286.
- Possemiers, S., Bolca, S., Grootaert, C., et al., 2006. The prenylflavonoid isoxanthohumol from hops is activate into the potent phytoestrogen 8-prenylnaringenin *in vitro* and in the human intestine. *J Nutr* 136(7), 1862-1867.
- Possemiers, S., Verthe, K., Uyttendaele, S., et al., 2004. PCR-DGGE-based quantification of stability of the microbial community in a simulator of the human intestinal microbial ecosystem. *FEMS Microbiol Ecol* 49(3), 495-507.
- Prakash, S., Rodes, L., Coussa-Charley, M., et al., 2011. Gut microbiota: next frontier in understanding human health and development of biotherapeutics. *Biologics* 5, 71-86.
- Prasad, J., Sazawal, S., Dhingra, U., et al., 2013. Detection of viable *Bifidobacterium lactis* HN019 (DR10 (TM)) in stools of children during a synbiotic dietary intervention trial. *Int Dairy J* 30(2), 64-67.
- Prescott, S. L., Wiltschut, J., Taylor, A., et al., 2008. Early markers of allergic disease in a primary prevention study using probiotics: 2.5-year follow-up phase. *Allergy* 63(11), 1481-1490.
- Prins, R. A., 1977. Biochemical activities of gut microorganisms, in *Microbial Ecology of the Gut* (eds. Clarke, R. T. J., Bauchop, T), Academic Press, New York.
- Probert, H. M., Apajalahti, J. H. A., Rautonen, N., et al., 2004a. Polydextrose, lactitol, and fructo-oligosaccharide fermentation by colonic bacteria in a three-stage continuous culture system. *Appl Environ Microbiol* 70(8), 4505-4511.
-

- 
- Probert, H. M., Gibson, G. R., 2004b. Development of a fermentation system to model sessile bacterial populations in the human colon. *Biofilms* 1(1), 13-19.
- Probert, H.M., Gibson, G.R., 2002. Bacterial biofilms in the human gastrointestinal tract. *Curr Issues Intest Microbiol* 3(2), 23-27.
- Qin, J., Li, R., Raes, J., et al., 2010. A human gut microbial gene catalogue established by
- Rajilic-Stojanovic, M., Smidt, H., de Vos, W.M., 2007. Diversity of the human gastrointestinal tract microbiota revisited. *Environ Microbiol* 9(9), 2125-2136.
- Rastall, R. A., Gibson, G. R., Gill, H. S., et al., 2005. Modulation of the microbial ecology of the human colon by probiotics, prebiotics and synbiotics to enhance human health: an overview of enabling science and potential applications. *FEMS Microbiol Ecol* 52(2), 145-152.
- Rautava, S., Kainonen, E., Salminen, S., et al., 2012. Maternal probiotic supplementation during pregnancy and breast-feeding reduces the risk of eczema in the infant. *J Allergy Clin Immunol* 130(6), 1355-1360.
- Reddy, B. S., Rivenson, A., 1993. Inhibitory effect of *Bifidobacterium longum* on colon, mammary and liver carcinogenesis induced by 2-amino-3-methylimidazo (4, 5-f) quinoline, a food mutagen. *Cancer Res* 53(17), 3914-3918.
- Reid, G., Jass, J., Sebulsky, M. T., et al., 2003a. Potential uses of probiotics in clinical practice. *Clin Microbiol Rev* 16(4), 658-672.
- Reid, G., Sanders, Me E., Gaskins, H. R., et al., 2003b. New scientific paradigms for probiotics and prebiotics. *J Clin Gastroenterol* 37(2), 105-118.
- Rinne, M., 2006. Probiotic intervention in the first months of life: short-term effects on gastrointestinal symptoms and long-term effects on gut microbiota. *J Pediatr Gastroenterol Nutr* 43(2), 200-205.
- Rinne, M., Kalliomaki, M., Arvilommi, H., et al., 2005. Effect of probiotics and breastfeeding on the *Bifidobacterium* and *Lactobacillus/Enterococcus* microbiota and humoral immune response. *J Pediatr* 147(2), 186-191.
- Roberfroid, M. B., Bornet, F., Bouley, C., et al., 1995. Colonic microflora: nutrition and health: summary and conclusions of an International Life Sciences Institute (ILSI) (Europe) workshop held in Barcelona, Spain. *Nutr Rev* 53, 127-130.
- Roberfroid, M., 1993. Dietary fibre, inulin and oligofructose: a review comparing their physiological effects. *Crit Rev Food Sci Nutr* 33(2), 103-148.
- Roberfroid, M., 2005. *Inulin-type Fructans, Functional Food Ingredients*, CRC Press, Boca Raton.
- Rodrigues, A. C., Nardi, R. M., Bambirra, E. A., et al., 1996. Effect of *Saccharomyces boulardii* against experimental oral infection with *Salmonella typhimurium* and *Shigella flexneri* in conventional and gnotobiotic mice. *J Appl Bacteriol* 81(3), 251-256.
- Roger, L. C., McCartney, A. L., 2010. Longitudinal investigation of the faecal microbiota of healthy full-term infants using fluorescence in situ hybridization and denaturing gradient gel electrophoresis. *Microbiology* 156(Pt 11), 3317-3328.
- Roos, S., Dicksved, J., Tarasco, V., et al., 2013. 454 pyrosequencing analysis on faecal samples from a randomized DBPC trial of colicky infants treated with *Lactobacillus reuteri* DSM 17938. *PLoS ONE* 8(2), e56710.
-

- 
- Rossi M., Corradini C., Amaretti A., et al., 2005. Fermentation of fructooligosaccharides and inulin by *bifidobacteria*: a comparative study in pure and faecal cultures. *Appl Environ Microbiol* 71(10), 6150-6158.
- Round, J. L., Mazmanian, S. K., 2010. Inducible Foxp3+ regulatory T-cell development by a commensal bacterium of the intestinal microbiota. *Proc Natl Acad Sci USA* 107, 12204-12209.
- Rowland, I. R., 1988. Factors affecting metabolic activity of the intestinal microbiota. *Drug Metab Rev* 19(3-4), 243-261.
- Rumney, C. J., Rowland, I. R., 1992. *In vivo* and *in vitro* models of the human colonic flora. *Crit Rev Food Sci Nutr* 31(4), 299-331.
- Saad, N., Delattre, C., Urdaci, M., et al., 2013. An overview of the last advances in probiotic and prebiotic field. *LWT-Food Sci Technol* 50 (1), 1-16.
- Sahl, J. W., Matalka, M. N., Rasko, D. A., 2012. Phylomark: a tool to identify conserved phylogenetic markers from whole-genome alignments. *Appl Environ Microbiol* 78(14), 4884-4892.
- Saikali, J., Picard, C., Freitas, M., et al., 2004. Fermented milks, probiotic cultures, and colon cancer. *Nutr Cancer* 49(1), 14-24.
- Salminen, S. J., Gueimonde, M., Isolauri, E., 2005. Probiotics that modify disease risk. *J Nutr* 135(5), 1294-1298.
- Salminen, S., Bouley, C., Boutron-Ruault, M. C., et al., 1998. Functional food science and gastrointestinal physiology and function. *Br J Nutr* 80 Suppl 1, S147-S171.
- Sanders, M. E., 2000. Considerations for use of probiotic bacteria to modulate human health. *J Nutr* 130(2), 384S-390S.
- Sands, B. E., 2004. From symptom to diagnosis: Clinical distinctions among various form of intestinal inflammation. *Gastroenterology* 126(6), 1518-1532.
- Sato, T., Matsumoto, K., Okumura, T., et al., 2008. Isolation of lactate-utilizing butyrate-producing bacteria from human feces and *in vivo* administration of anaerostipes caccae strain 12 and galactooligosaccharides in a rat model. *FEMS Microbiol Ecol* 66(3), 528-536.
- Saulnier, D. M., Gibson, G. R., Kolida, S., 2008. *In-vitro* effects of selected synbiotics on the human faecal microorganisms composition. *FEMS Microbiol Ecol* 66(3), 516-527.
- Savage, D.C., 1977. Microbial ecology of the gastrointestinal tract. *Annu Rev Microbiol* 31, 107-133.
- Scanlan, P.D., Marchesi, J.R., 2008. Micro-eukaryotic diversity of the human distal gut microbiota: qualitative assessment using culture-dependent and -independent analysis of faeces. *ISME J* 2(12), 1183-1193.
- Schink, B., 1997. Energetics of syntrophic cooperation in methanogenic degradation. *Microbiol Mol Biol Rev* 61(2), 262-280.
- Schrezenmeir, J., De Vrese, M., 2001. Probiotics, Prebiotics, and synbiotics- approaching a definition. *Am J Clin Nutr* 73 (2 Suppl), 361S-364S.
- Seale, J. V., Millar, M., 2013. Probiotics: a new frontier for infection control. *J Hosp Infect* 84(1), 1-4.
-



- 
- Sekirov, I., Russell, S. L., Antunes, L. C. M., et al., 2010. Gut microbiota in health and disease. *Physiol Rev* 90(3), 859-904.
- Sghir, A., Chow, J. M., Mackie, R. I., 1998. Continuous culture selection of *Bifidobacteria* and *Lactobacilli* from human faecal samples using fructooligosaccharide as selective substrate. *J Appl Microbiol* 85(4), 769-777.
- Shahinas, D., Silverman, M., Sittler, T., et al., 2012. Toward an understanding of changes in diversity associated with fecal microbiome transplantation based on 16S rRNA gene deep sequencing. *mBio* 3(5):e00338-12.
- Shanahan F., 2001. Inflammatory bowel disease: immunodiagnostics, immunotherapeutics, and ecotherapies. *Gastroenterology* 120(3), 622-635.
- Shanahan, F., 2013. The colonic microbiota in health and disease. *Curr Opin Gastroen* 29(1), 49-54.
- Shendure, J., Porreca, G. J., Reppas, N. B., et al., 2005. Accurate multiplex polony sequencing of an evolved bacterial genome. *Science* 309(5741), 1728-1732;
- Shene C., Mardones M., Zamora P., et al., 2005. Kinetics of *Bifidobacterium longum* ATCC 15707 fermentations: effect of the dilution rate and carbon source. *Appl Microbiol Biotechnol* 67(5), 623-630.
- Shi, L., Li, M., Miyazawa, K., et al., 2013. Effects of heat-inactivated *Lactobacillus gasseri* TMC0356 on metabolic characteristics and immunity of rats with the metabolic syndrome. *Brit J Nutr* 109(2), 263-272.
- Shoaf, K., Mulvey, G. L., Armstrong, G. D., et al., 2006. Prebiotic galactooligosaccharides reduce adherence of enteropathogenic *Escherichia coli* to tissue culture cells. *Infect Immun* 74(12), 6920-6928.
- Sim, K., Cox, M. J., Wopereis, H., et al., 2012. Improved detection of *Bifidobacteria* with optimised 16S rRNA-gene based pyrosequencing. *PLoS One* 7(3), e32543.
- Simon GL, Gorbach SL., 1984. Intestinal flora in health and disease. *Gastroenterology* 86(1), 174-193.
- Sjogren, Y. M., Tomicic, S., Lundberg, A., et al., 2009. Influence of early gut microbiota on the maturation of childhood mucosal and systemic immune responses. *Clin Exp Allergy* 39(12), 1842-1851.
- Smith, E. A., Macfarlane, G. T., 1996. Enumeration of human colonic bacteria producing phenolic and indolic compounds: effect of pH, carbohydrate availability and retention time on dissimilatory aromatic amino acid metabolism. *J Appl Bacteriol* 81(3), 288-302.
- Smith, K., McCoy, K. D., Macpherson, A. J., 2007. Use of axenic animals in studying the adaptation of mammals to their commensal intestinal microbiota. *Semin Immunol* 19(2), 59-69.
- Socol, C. R., Vandenberghe, L. P., Spier, M. R., et al., 2010. The potential of probiotics: a review. *Food Technol Biotechnol* 48(4), 413-434.
- Soh, S. E., Aw, M., Gerez, I., et al., 2009. Probiotic supplementation in the first 6 months of life in at risk Asian infants -- effects on eczema and atopic sensitization at the age of 1 year. *Clin Exp Allergy* 39(4), 571-578.
- Sonnenburg, J. L., Xu, J., Leip, D. D., et al., 2005. Glycan foraging *in vivo* by an intestine-adapted bacterial symbiont. *Science* 307(5717), 1955-1959.
-

- 
- Souliman, S., Beyssac, E., Cardot, J. M., et al., 2007. Investigation of the biopharmaceutical behaviour of theophylline hydrophilic matrix tablets using USP methods and an artificial digestive system. *Drug Dev Ind Pharm* 33(4), 475-483.
- Souliman, S., Blanquet, S., Beyssac, E., et al., 2006. A level A *in vitro/in vivo* correlation in fasted and fed states using differ methods: applied to solid immediate release oral dosage form. *Eur J Pharm Sci* 27(1), 72-79.
- Southgate, D. A. T., 1995. Digestion and metabolism of sugars. *Am J Clin Nutr* 62 (1 Suppl), 203S-211S.
- Southgate, D. A. T., Waldron, K., Johnson I. T., et al., 1990. *Dietary fibre: chemical and biological aspects*. Royal Society of Chemistry, Cambridge.
- Stecher, B., Chaffron, S., Kappeli, R., et al. 2010. Like will to like: abundances of closely related species can predict susceptibility to intestinal colonization by pathogenic and commensal bacteria. *PLoS Pathog* 6(1), e1000711.
- Stemmons, E. D., Smith, H., 2000. Competition in a chemostat with wall attachment. *SIAM J. Appl. Math.* 61(2), 567-595.
- Stephen, A. M., Cummings, J. H., 1979. Water holding by dietary fibre *in vitro* and its relationship to faecal output in man. *Gut* 20(8), 722-729.
- Stephen, A. M., Cummings, J. H., 1980. The microbial contribution to fecal mass. *J Med Microbiol* 13(1), 45-56.
- Stewart, M. L., Timm, D. A., Slavin, J. L., 2008. Fructooligosaccharides exhibit more rapid fermentation than long-chain inulin in an *in vitro* fermentation system. *Nutr Res* 28(5), 329-334.
- Storro, O., Oien, T., Dotterud, C. K., et al., 2010. A primary health-care intervention on pre- and postnatal risk factor behaviour to prevent childhood allergy. The Prevention of Allergy among Children in Trondheim (PACT) study. *BMC Public Health* 10, 443-454.
- Strausberg, R. L., Levy, S., Rogers, Y. H., 2008. Emerging DNA sequencing technologies for human genomic medicine. *Drug Discov Today* 13(13-14), 569-577.
- Suau A., Bonnet R., Sutren M., 1999. Direct analysis of genes encoding 16S rRNA from complex communities reveals many novel molecular species within the human gut. *Appl Environ Microbiol* 65(11), 4799-4807.
- Suvarna, V. C., Bobby, V. U., 2005. Probiotics in human health: a current assessment. *Curr Sci* 88(11), 1744-1745.
- Swidsinski, A., Loening-Baucke, V., Theissig, F., et al., 2007. Comparative study of the intestinal mucus barrier in normal and inflamed colon. *Gut* 56(3), 3443-350.
- Taguchi, H., Takahashi, M., Yamaguchi, H., et al., 2002. Experimental infection of germfree mice with hyper-toxicogenic enterohaemorrhagic *Escherichia coli* O 157:H7, strain 6. *J Med Microbiol* 51(4), 336-343.
- Tang, M. L. K., Lahtinen, S. J., Boyle, R. J., 2010. Probiotics and prebiotics: clinical effects in allergic disease. *Curr Opin Pediatr* 22(5), 626-634.
- Tannock G.W., 1995. *Normal Microflora: An Introduction to Microbes Inhabiting the Human Body*. Chapman & Hall, London.
- Taylor, A. L., Dunstan, J. A., Prescott, S. L., 2007. Probiotic supplementation for the first 6 months of life fails to reduce the risk of atopic dermatitis and increases the risk of atopic
-

- dermatitis and increases the risk of allergen sensitization in high-risk children: a randomized controlled trial. *J Allergy Clin Immunol* 119(1), 184-191.
- Thomas, D. W., Greer, F. R., 2010. Probiotics and prebiotics in pediatrics. *Pediatrics* 126(6), 1217-1231.
- Timoshenko, S., Woinowsky-Krieger, S., 1959. *Theory of Plates and Shells*, second ed. McGraw-Hill, New York.
- Titgemeyer, E. C., Bourquin, L. D., Fahey, G. C. J., et al., 1991. Fermentability of various fibre sources by human fecal bacteria *in vitro*. *Am J Clin Nutr* 53(6), 1418-1424.
- Tjellstrom, B., Stenhammar, L., Hogberg, L., et al., 2007. Gut microflora associated characteristics in first degree relatives of children with celiac disease. *Scand J Gastroenterol* 42(10), 1204-1208.
- Traskalova-Hogenova, H., Stepankova, R., Kozakova, H., et al., 2011. The role of gut microbiota (commensal bacteria) and the mucosal barrier in the pathogenesis of inflammatory and autoimmune diseases and cancer: contribution of germfree and gnotobiotic animal models of human diseases. *Cell Mol Immunol* 8(2), 110-120.
- Turnbargh, P. J., Ley, R. E., Hamady, M., et al., 2007. The human microbiome project. *Nature* 449, 804-810.
- Turnbaugh, P. J., Hamady, M., Yatsunencko, T., et al., 2009a. A core gut microbiome in obese and lean twins. *Nature* 457(7228), 480-484.
- Turnbaugh, P. J., Ley, R. E., Mahowald, M. A., et al., 2006. An obesity-associated gut microbiome with increased capacity for energy harvest. *Nature* 444, 1027-1031.
- Turnbaugh, P. J., Ridaura, V. K., Faith, J. J., et al., 2009b. The effect of diet on the human gut microbiome: a metagenomic analysis in humanized gnotobiotic mice. *Sci Transl Med* 1(6), 6ra14.
- Turrone, F., Peano, C., Pass, D. A., et al., 2012. Diversity of *Bifidobacteria* within the infant gut microbiota. *PLoS One* 7(5), e36957.
- Tyson, G. W., Chapman, J., Hugenholtz, P., et al., 2004. Community structure and metabolism through reconstruction of microbial genomes from the environment. *Nature* 428, 37-43.
- Umesaki, Y., 1989. Intestinal glycolipids and their role in intestinal colonization of mice. *Bifidobacteria Microflora* 8(1), 13-22.
- Underwood, M. A., Salzman, N. H., Bennett, S. H., et al., 2009. A randomized placebo-controlled comparison of 2 prebiotic/probiotic combinations in preterm infants: impact on weight gain, intestinal microbiota, and fecal short-chain fatty acids. *J Pediatr Gastroenterol Nutr* 48(2), 216-225.
- Vaishampayan, P. A., Kuehl, J. V., Froula, J. L., et al., 2010. Comparative metagenomics and population dynamics of the gut microbiota in mother and infant. *Genome Biol Evol* 2, 53-66.
- Van de Wiele, T., Boeckaert, C., Verstraete, W., et al., 2003. Oral exposure to PAH: bioactivation processes in the human gut. *Commun Agric Appl Biol Sci* 68(3), 3-6.
- Van de Wiele, T., Boon, N., Possemiers, S., et al., 2007. Inulin-type fructans of longer degree of polymerization exert more pronounced *in vitro* prebiotic effects. *J Appl Microbiol* 102 (2), 452-460.

- 
- Van de Wiele, T., Boon, N., Possemiers, S., Jacobs, H., et al., 2004. Prebiotic effects of chicory inulin in the simulator of the human intestinal microbial ecosystem. *FEMS Microbiol Ecol* 51(1), 143-153.
- Van den Abbeele, P., Belzer, C., Goossens, et al., 2013. Butyrate-producing *Clostridium* cluster XIVa species specifically colonize mucins in an *in vitro* gut model. *ISME J* 7(5), 949-961.
- Van den Abbeele, P., Grootaert, C., Marzorati, M., et al., 2010. Microbial community development in a dynamic gut model is reproducible, colon region specific, and selective for *Bacteroidetes* and *Clostridium* cluster IX. *Appl Environ Microbiol* 76(15), 5237-5246.
- Van den Abbeele, P., Grootaert, C., Possemiers, S., et al., 2009. *In vitro* model to study the modulation of the mucin-adhered bacterial community. *Appl Microbiol Biotechnol* 83(2), 349-359.
- Van den Abbeele, P., Roos, S., Eeckhaut, V., et al., 2012. Incorporating a mucosal environment in a dynamic gut model results in a more representative colonization by lactobacilli. *Microb Biotechnol* 5(1), 106-115.
- Van der Waaij, D., Van der Waaij, B. D., 1990. The colonization resistance of the digestive tract in different animal species and in man: a comparative study. *Epidemiol Infect* 105(2), 237-243.
- Van Niel, C. W., Feudtner, C., Garrison, M. M., 2002. *Lactobacillus* therapy for acute infectious diarrhoea in children: a meta-analysis. *Paediatr* 109(4), 678-684.
- Van Nimwegen, F. A., Penders, J., Stobberingh, E. E., et al., 2011. Mode and place of delivery, gastrointestinal microbiota, and their influence on asthma and atopy. *J Allergy Clin Immunol* 128(5), 948-955.
- Vasiljevic, T., Shah, N. P., 2008. Probiotics- from Metchnikoff to bioactives. *Int Dairy J* 18(7), 714-728.
- Vaughan, E. E., de Vries, M. C., Zoetendal, E. G., et al., 2002. The intestinal LABs. *Anton Leeuw* 82, 341-352.
- Vaughan, E. E., Schut, F., Heilig, H. G. H. J., et al., 2000. A molecular view of the intestinal ecosystem. *Curr Issues Intest Microbiol* 1(1), 1-12.
- Ventura, M., Zink, R., 2002. Rapid identification, differentiation, and proposed new taxonomic classification of *Bifidobacterium lactis*. *Appl Environ Microbiol* 68(12), 6429-6434.
- Verberkmoes, N. C., Russell, A. L., Shah, M., et al., 2009. Shotgun metaproteomics of the human distal gut microbiota. *ISME J* 3(2), 179-189.
- Vermeiren, J., Possemiers, S., Marzorati, M., et al., 2011. Chapter 7: The gut microbiota as target for innovative drug development: perspectives and a case study of inflammatory bowel diseases In *Drug development - A case study based insight into modern strategies* (ed. Rundfeldt, R.), In tech, Croatia .
- Vermeiren, J., Van den Abbeele, P., Laukens, D., et al., 2012. Decreased colonization of fecal *Clostridium coccoides/Eubacterium rectale* species from ulcerative colitis patients in an *in vitro* dynamic gut model with mucin environment. *FEMS Microbiol Ecol* 79(3), 685-696.
- Vyas, U., Ranganathan, N., 2012. Review article: Probiotics, prebiotics, and synbiotics: gut and beyond. *Gastroenterol Res Pract* 2012(2012), 872716.
-

- 
- Walker, A. W., Duncan, S. H., Leitch, E. C. M., et al., 2005. pH and peptide supply can radically alter bacterial populations and short-chain fatty acid ratios within microbial communities from the human colon. *Appl Environ Microbiol* 71(7), 3692-3700.
- Walker, A.W., Duncan, S.H., Harmsen, H.J. M., et al., 2008. The species composition of the human intestinal microbiota differs between particle-associated and liquid phase communities. *Environ Microbiol* 10(12), 3275-3283.
- Walter, J., Ley, R., 2011. The human gut microbiome: ecology and recent evolutionary changes. *Annu Rev Microbiol* 65, 411-429.
- Waltman, P. (ed), 1984. *Competition Models in Population Biology*, part of *CBMS-NSF Regional Conference Series in Applied Mathematics*, Cambridge University Press.
- Wang, M., Ahrne, S., Jeppsson, B., et al., 2005. Comparison of bacterial diversity along the human intestinal tract by direct cloning and sequencing of 16S rRNA genes. *FEMS Microbiol Ecol* 54(2), 219-231.
- Wang, M., Karlsson, C., Olsson, C., et al., 2008. Reduced diversity in the early fecal microbiota of infants with atopic eczema. *J Allergy Clin Immunol* 121(1), 129-134.
- Wang, X., Giboson, G. R., 1993. Effect of the *in vitro* fermentation of oligofructose and inulin by bacteria growing in the human intestine. *J Appl Microbiol* 75(4), 373-380.
- Weichert, S., Schrotten, H., Adam, R., 2012. The role of prebiotics and probiotics in prevention and treatment of childhood infectious diseases. *Pediatr Infect Dis J* 31(8), 859-862.
- Whitman, M. S., Pitsakis, P. G., DeJesus, E., et al., 1996. Gastrointestinal tract colonization with vancomycin-resistant *Enterococcus faecium* in an animal model. *Antimicrob Agents Chemother* 40(6), 1526-1530.
- WHO (World Health Organization), 2002. Guidelines for the evaluation of probiotics in food. Report of a joint FAO/WHO working group on drafting guidelines for the evaluation of probiotics in food. Available at: [http://www.int/foodsafety/fs\\_management/en/probiotic\\_guidelines.pdf](http://www.int/foodsafety/fs_management/en/probiotic_guidelines.pdf).
- Wickens, K., Black, P. N., Stanley, T. V., et al., 2008. A differential effect of 2 probiotics in the prevention of eczema and atopy: a double-blind, randomized, placebo-controlled trial. *J Allergy Clin Immunol* 122(4), 788-794.
- Wikoff, W. R., Anfora, A. T., Liu, J., et al., 2009. Metabolomics analysis reveals large effects of gut microflora on mammalian blood metabolites. *Proc Natl Acad Sci USA* 106, 3698-3703.
- Wilkinson, M. H. F., 2002a. *Model Intestinal Microflora in Computer Simulation (MIMICS) Technical Report: MIMICS Cellular Automation Program Design and Performance Testing*, University of Groningen, The Netherlands.
- Wilkinson, M. H. F., 2002b. *Model Intestinal Microflora in Computer Simulation (MIMICS) Technical Report: Ordinary Differential Equations for Modelling Bacterial Interactions in the Gut*, University of Groningen, The Netherlands.
- Wilkinson, M. H. F., 2002c. Model intestinal microflora in computer simulation: a simulation and modeling package for host-microflora interactions, *IEEE Trans. Biomed. Eng.* 49(10), 1077-1085.
-

- 
- Williams, E. A., Stimpson, J., Wang, D., et al., 2009. Clinical trial: a multistrain probiotic preparation significantly reduces symptoms of irritable bowel syndrome in a double-blind placebocontrolled study. *Aliment Pharmacol Ther* 29(1), 97-103.
- Wilson, K., 1995. The gastrointestinal microflora. In *Textbook of Gastroenterology* (ed. Yamada, T.), Wiley-Blackwell, Philadelphia.
- Wold, A. E., 2001. Immune effects of probiotics. *Scand J Nutr* 45, 76-85.
- Wolin, M. J., 1981. Fermentation in the rumen and human large intestine. *Science* 213(4515), 1463-1468.
- Wolin, M. J., Miller, T. L., 1983. Carbohydrate fermentation, in Human Intestinal Microflora. In *Health and Disease* (ed. Hentges, D. J), Academic Press, New York.
- Wolin, M. J., Miller, T. L., 1994. CO<sub>2</sub> acetogenesis in the human colonic ecosystem. In *Acetogenesis* (ed. Drake, H. L), Chapman & Hall, London.
- Wu, G. D., Lewis, J. D., Hoffmann, C., et al., 2010. Sampling and pyrosequencing methods for characterizing bacterial communities in the human gut using 16S sequence tags. *BMC Microbiol* 10, 206.
- Xu, J., Gordon, J. I., 2003. Inaugural article: Honor thy symbionts. *Proc Natl Acad Sci USA* 100(18), 10452-10459.
- Xu, X. F., Xu, P. P., Ma, C. W., et al., 2013. Gut microbiota, host health, and polysaccharides. *Biotechnol Adv* 31(2), 318-337.
- Yamashita, K., Kawai, K., Itakura, M., 1984. Effects of fructo-oligosaccharides on blood glucose and serum lipids in diabetic subjects. *Nutr Res* 4(6), 961-966.
- Yeoh, G. H., Tu, J., 2010. *Computational Techniques for Multi-Phase Flows*. Butterworth-Heinemann.
- Yi, P., Li, L. J., 2012. The germfree murine animal: An important animal model for research on the relationship between gut microbiota and the host. *Vet Microbiol* 157(1-2), 1-7.
- Yolanda, S., 2011. Gut microbiota and probiotics in maternal and infant health. *Am J Clin Nutr* 94 (Suppl), 2000S-2005S.
- Younes, H., Coudray, C., Bellanger, J., et al., 2001. Effects of two fermentable carbohydrates (inulin and resistant starch) and their combination on calcium and magnesium balance in rats. *Br J Nutr* 86(4), 479-485.
- Zhu, Y., Michelle, L. T., Jobin, C., et al., 2011. Gut microbiota and probiotics in colon tumorigenesis. *Cancer Lett* 309(2), 119-127.
- Ziemer, C. J., Gibson, G. R., 1998. An overview of probiotics, prebiotics and synbiotics in the functional food concept: perspectives and future strategies. *Int Dairy J* 8(5-6), 473-479.
- Zihler, A., Gagnon, M., Chassard, C., et al., 2010. Unexpected consequences of administering bacteriocinogenic probiotic strains for *Salmonella* populations, revealed by an *in vitro* colonic model of the child gut. *Microbiology* 156(Pt 11), 3342-3353.
- Zihler, A., Gagnon, M., Chassard, C., et al., 2011. Protective effect of probiotics on *Salmonella* infectivity assessed with combined *in vitro* gut fermentation-cellular models. *BMC Microbiol* 11, 264.
-

## References

---

- Zoetendal, E. G., Akkermans, A. D. L., De Vos, W. M., 1998. Temperature gradient gel electrophoresis analysis of 16S rRNA from human fecal samples reveals stable and host-specific communities of active bacteria. *Appl Environ Microbiol* 64(10), 3854-3859.
- Zoetendal, E. G., Rajilic-Stojanovic, M., de Vos W. M., 2008. High-throughput diversity and functionality analysis of the gastrointestinal tract microbiota. *Gut* 57(11), 1605-1615.
- Zoetendal, E.G., Cheng, B., Koike, S., et al., 2004. Molecular microbial ecology of the gastrointestinal tract: from phylogeny to function. *Curr Issues Intest Microbiol* 5(2), 31-47.
- Zoetendal, E.G., von Wright, A., Vilpponen-Salmela, T., et al., 2002. Mucosa-associated bacteria in the human gastrointestinal tract are uniformly distributed along the colon and differ from the community recovered from feces. *Appl Environ Microbiol* 68(7), 3401-3407.
- Zwietering, M. H., Jongenburger, I., Rombouts, F. M., et al., 1990. Modeling of the bacterial growth curve. *Appl Environ Microbiol* 56, 1875-1881.